



ACCESORIOS

CATÁLOGO 2022 / 2023



2022 / 2023
1ª edición



www.makita.com.mx

Makita



CAMPING MAKITA

RULE THE OUTDOORS

Productos de la línea:

-  - 40Vmax XGT
-  - 18V LXT
-  - 12Vmax CXT

Toda una línea de productos inalámbricos para acampar, pícnic ó cualquier lugar al aire libre.

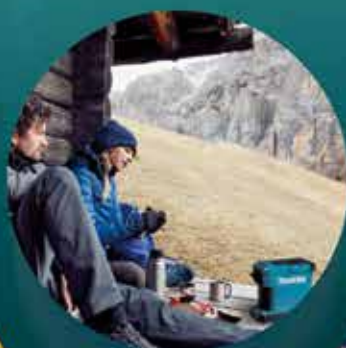

LIMPIA EL ÁREA

Despeja el área de hojas y ramas para mayor comodidad en tu estancia



ILUMINA EL ESPACIO

Coloca lámparas para iluminar al exterior ó el interior de tu casa de campaña



REFRÉSCATE

Mantén bebidas frías y tus alimentos a buena temperatura para la hora de hidratarte ó comer.

DIVIÉRTETE

Práctica tu deporte favorito, juega y diviértete con música



ABRÍGATE

Ten una buena noche, una bebida caliente y una manta térmica ideales para acampar



Garantía

Calidad en herramientas eléctricas e industriales garantizada al 100%



Makita ofrece en todas sus herramientas industriales y profesionales la **Garantía de 1 año.**

En la compra de tu herramienta recibe la **Póliza de Garantía limitada por un año,** verifica que esta venga incluida en la caja o estuche de tu herramienta.

Para hacer efectiva la garantía es necesario presentar la herramienta y la póliza con el sello del establecimiento donde la compró, en caso de no contar con la poliza, puede presentar su factura de compra.



Además 6 meses de **Garantía Extendida**

Ingresa a www.makita.com.mx y registra tu herramienta



Encuentra nuestros Centros de Servicio

¿No hay Centros de Servicio Autorizados en tu ciudad?

NO TE PREOCUPES, nosotros te ayudamos a que tu herramienta vuelva a funcionar, contáctanos en los correos: jorge.rodriguez@makita.com.mx y benjamin.rodriguez@makita.com.mx

IMPORTADO POR: Makita México, S.A de C.V.
CAMINO VIEJO A SAN LORENZO TEPALITLÁN (JOSÉ MARTÍ) No.227
COL. TLACOPA TOLUCA, ESTADO DE MÉXICO C.P. 50010

GARANTÍA MAKITA LIMITADA POR UN AÑO PÓLIZA DE GARANTÍA

Cada herramienta Makita está cuidadosamente inspeccionada y probada antes de salir de fábrica. Esta póliza está libre de defectos de funcionamiento y materiales, no obstante esta garantía por el periodo de un año a partir de la fecha de compra, cubre cualquier defecto de fábrica así como en repuestos y piezas de repuesto de servicio autorizados por Makita. Si surge algún problema durante este periodo, llévelo al producto más cercano a Makita México S.A. de C.V. o al representante autorizado de Makita en su país. Este producto no incluye componentes de repuesto de fábrica, incluyendo, la línea de serie, así como los gastos de transporte del producto dentro de la red de puntos de Makita y demás gastos necesarios para que el producto sea devuelto a la red de puntos de Makita y demás gastos necesarios en el caso de que el producto sea devuelto a la red de puntos de Makita.

Esta garantía aplica salvo las siguientes excepciones:

Cuando el producto no hubiera sido operado de acuerdo al manual de uso o manual de instrucciones que lo acompaña.
Cuando el producto hubiera sido alterado o reparado por personas no autorizadas por el fabricante nacional, importador o comercializador respectivamente.

En caso de que el producto haya sido reparado o sometido a mantenimiento y el mismo presente averías de cualquier naturaleza, este tendrá derecho a que sea reemplazado o reparado de nuevo por el mismo tiempo de garantía que el producto original.

Cuando el usuario haya sido reparado o sometido a mantenimiento de cualquier naturaleza por el mismo tiempo de garantía que el producto original.

NOTA: Al término de la presente garantía, el cliente podrá optar a cualquier centro de servicio autorizado Makita en su país, donde se hará cargo del servicio de reparación y mantenimiento de su producto, con sus costos correspondientes.

Procedimiento para hacer efectiva esta garantía

Deberá presentar el producto y esta póliza sellada por el establecimiento comercial donde se adquirió, de no contar con esta, basará la factura de compra. En caso de no contar con centros de servicio autorizados en la región donde usted se encuentre, podrá solicitar que se haga efectiva la garantía ante el propio casa comercial donde se adquirió el producto.

DATOS DEL CLIENTE

NOTA: Los datos deben ser llenados y sellados por el distribuidor

FECHA DE COMPRA

No. DE FACTURA

DISTRIBUIDOR

DIRECCIÓN

MODELO

No. SERIE

SELLO DEL DISTRIBUIDOR

886042E6



ÍNDICE

BLUE COLLECTION

HERRAMIENTA MANUAL

BROCAS METAL - MADERA

BROCAS CONCRETO

PUNTAS

SET DE BROCAS Y PUNTAS

**BATERÍAS, LÁMPARAS Y
CARGADORES**

HOJAS DE SIERRA

SEGUETAS



33



39

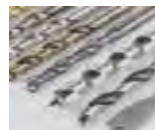

48



75



96



127



136



145



158

CARDAS
DISCOS ABRASIVOS
PRODUCTOS DE LIJA Y FIBRA
MULTIHERRAMIENTA
DISCOS DE DIAMÁNTE
FRESAS PARA ROUTER
ACCESORIOS PARA
EQUIPO EXTERIOR
MISCELANEA
ACCESORIOS PARA ASPIRADORAS
JUEGOS DE SERVICIO
Y CARBONES

172

180

197

216

222

241

259

270

283

289



ÍNDICE

0042010	58	122853-8	214	135332-7	274	164775-6	243
007431-0	200	122854-6	272	135398-7	262	164776-4	243
007432-0	200	122859-6	285	135465-8	262	164834-6	243
042040-2A	291	122882-1	262	135629-4	274	165053-7	274
060000015N	171	122886-3	274	140115-2	214	165055-3	274
060040000N	171	122890-2	274	140424-9	262	165201C8	265
0717059990	171	122892-8	274	140440-1	212	165202D6	265
0722104800	268	122906-3	264	140583-9	262	165245-8	265
0722105000	264	122918-6	287	140G04-3	285	165362-4	274
110702-A	278	122930-6	272	140H94-2	285	166078-4	214
110706-A	278	1229314	262	140H95-0	286	166079-2	214
110720-A	278	122938-0	274	140J64-3	286	166084-9	214
110730-A	278	122939-8	274	141247-8	245	166095-4	142
110742-A	278	123004-6	170	142403-3	244	166116-2	287
110751-A	278	123009-6	170	143600-4	235	168313-6	275
122212-6	117	123022-4	243	143602-0	235	168349-5	277
122213-4	117	123029-0	243	150662-5	272	1684085	265
122256-6	242	123030-5	168	150796-4	272	1684506	265
122291-4	285	123053-3	170	151449-8	287	168467-9	281
122296-4	214	123055-9	170	151517-7	214	181019-9	290
122297-2	214	123058-3	243	152456-4	214	181490-7	291
122321-1	214	123060-6	170	152483-1	117	181503-4	290
122329-5	214	123062-2	170	152491-2	274	182229-1	266
122339-2	214	123138-5	274	152492-0	274	185200-6	291
122343-1	243	123200-6	272	152521-9	274	191383-0	169
122351-2	214	123203-0	214	152539-0	274	191395-3	274
122387-1	235	123241-2	264	153489-2	274	191454-3	170
122402-1	214	123542-8	274	153503-4	274	191455-1	170
122428-3	274	123543-6	274	153504-2	274	191496-7	285
122446-1	272	123643-2	279	153898-5	272	191569-6	170
122450-0	117	123784-4	279	153909-6	125	191657-9	285
122470-4	272	125112-9	169	154427-7	285	191724-0	285
122472-0	275	125267-0	274	154676-6	274	191750-9	286
122473-8	245	125354-5	169	154767-3	274	191897-9	156
122474-6	214	125802-4	264	154768-1	274	191A57-9	236
122512-4	286	126187-1	264	158024-1	142	191C09-2	140
122520-5	285	126756-8	285	158057-6	274	191C26-2	287
122536-0	272	126766-5	279	158131-0	274	191D71-3	287
122540-9	272	127104-4	280	158323-1	211	191D75-5	287
122548-3	214	127669-6	170	158476-6	265	191D89-4	262
122555-6	272	127725-2	287	1584766	265	191D90-9	262
122556-4	272	132025-7	264	158835-4	235	191D91-7	262
122562-9	214	132025-7	286	158969-3	272	191D92-5	262
122563-7	272	132276-260	168	158970-8	272	191D93-3	262
122571-8	272	134152-6	235	161509-8	264	191E23-6	260
122625-1	272	134182-7	286	161510-3	264	191J40-0	142
122700-3	242	134887-9	275	162518-0	287	191J59-9	236
122707-9	272	134890-0	275	162523-7	287	191J61-2	141
122729-9	272	134909-5	275	164021-7	272	191J77-7	141
122730-4	272	135107-4	274	164095-8	272	191J93-9	141
122735-4	272	135108-2	274	164113-2	168	191L22-4	236
122740-1	272	135197-7	274	164379-4	243	191L70-3	141
122822-9	274	135209-6	274	164393-0	243	191M27-0	275
122852-0	214	135269-8	275	164470-8	243	191M39-3	287

191M70-9	141	193366-6	243	194972-0	290	195299-1	261
191P11-3	267	193379-7	244	194974-6	290	195300-2	261
191T86-6	265	193390-9	291	194975-4	290	195386-6	274
191T87-4	265	193391-7	291	194976-2	290	195432-5	287
191T88-2	265	193392-5	291	194977-0	290	195433-3	285
191T90-5	265	193393-3	291	194982-7	290	195434-1	285
191T91-3	265	193396-7	291	194984-3	290	195436-7	285
191T92-1	265	193402-8	291	194985-1	290	195438-3	286
191U29-4	141	193448-4	243	194986-9	290	195441-4	287
191U43-0	141	193472-7	274	194987-7	290	195446-4	275
191V16-9	141	193520-2	74	194991-6	290	195532-1	269
191X03-0	265	193606-2	291	194992-4	290	195544-4	285
191X04-8	265	193606-4	291	194993-2	290	195545-2	285
191Y94-7	141	193681-8	142	194994-0	290	195546-0	285
192016-0	74	193689-2	142	194996-6	290	195547-8	285
192035-6	244	193691-5	74	194997-4	290	195548-6	285
192236-6	286	193822-6	74	194997-4	290	195551-7	286
192501-3	272	193903-6	275	195001-2	290	195552-5	287
192547-9	168	193956-5	275	195005-4	290	195553-3	286
192562-3	285	194033-6	125	195007-0	290	195554-1	286
192563-1	285	194034-4	125	195008-8	290	195555-9	287
192613-2	212	194041-7	74	195012-7	290	1955656	268
192622-1	272	194079-2	74	195013-5	290	195611-5	287
192628-9	272	194080-7	74	195017-7	290	195612-3	286
192629-7	212	194086-5	272	195018-5	290	195624-6	261
192669-5	272	194087-3	272	195020-8	290	195720-0	260
192671-8	272	194088-1	142	195021-6	290	195720-0	264
192672-6	272	194092-0	125	195022-4	290	195798-3	142
192673-4	272	194093-8	272	195023-2	290	195845-0	290
192732-4	168	194175-6	275	195024-0	290	195871-9	86
192733-2	168	194241-9	272	195025-8	290	195896-3	275
192797-6	272	194254-0	74	195081-8	74	196074-8	275
192798-4	272	194289-1	275	195103-4	291	196092-6	244
192978-2	212	194303-3	274	195113-1	291	196093-4	244
192987-1	244	194310-6	125	195114-9	291	196094-2	244
193073-1	243	194311-4	125	1951490	262	196100-3	260
193103-8	244	194312-2	125	195191-1	291	196129-9	264
193104-6	244	194385-5	157	195192-9	291	196142-7	264
193143-6	244	194416-0	157	195195-3	291	196152-4	211
193155-9	244	194417-8	157	195198-7	291	196193-0	74
193181-4	291	194483-5	274	195199-5	291	196303-9	260
193214-9	244	194514-0	274	195201-4	291	196351-8	142
193215-7	244	194543-3	274	195204-8	291	196352-6	142
193235-1	243	194566-1	286	195205-6	291	196454-8	290
193243-2	291	194579-2	157	195206-4	291	196499-6	264
193244-0	291	194649-7	142	195206-4	291	196519-6	265
193261-0	243	194683-7	291	195231-5	142	196616-8	264
193262-8	243	194731-2	142	195236-5	225	196664-7	157
193263-6	243	194919-4	142	195236-5	274	196684-1	212
193264-4	243	194935-6	243	1952496	264	196740-7	265
193265-2	243	194963-1	290	1952527	264	196749-9	260
193266-0	243	194968-1	290	195253-5	272	196846-1	274
193283-0	291	194970-4	290	195263-2	291	196858-4	275
193326-8	285	194971-2	290	195298-3	261	196865-7	291

196911-6	264	197916-9	213	199090-9	244	224379-7	271
196918-2	291	197918-5	213	199141-8	157	224385-2	271
196953-0	157	197920-8	213	199184-0	260	224395-9	271
197005-0	157	197923-2	213	199184-0	260	224396-7	271
197030-1	262	197929-0	213	199321-6	260	224399-1	271
197043-2	142	198058-2	260	199342-8	260	224405-2	271
197127-6	291	198087-5	141	199431-9	286	224406-0	271
197148-8	275	198150-4	286	199439-3	286	224409-4	271
197168-2	275	198183-9	286	199491-1	287	224428-0	271
197189-4	261	198306-9	128	199556-9	275	224429-8	271
197195-9	142	198384-9	261	199558-5	275	224431-1	271
197210-9	129	198427-7	261	199709-0	274	224432-9	271
197211-7	129	198511-8	274	199710-5	274	224458-1	271
197212-5	129	198523-1	286	199826-6	157	224467-0	271
197213-3	129	198525-7	286	199827-4	287	224501-6	271
197234-5	264	198526-5	286	199966-0	287	224505-8	271
197244-2	290	198534-6	285	199992-9	141	224512-1	271
197252-3	157	198541-9	285	2097055108	290	224512-1	271
197462-2	157	198543-5	285	224019-7	271	224517-1	271
197465-6	211	198548-5	285	224080-4	271	224526-0	271
197466-4	211	198549-3	285	224081-2	271	224568-4	271
197472-9	262	198552-4	285	224083-8	271	224568-4	271
197473-7	262	198555-8	285	224089-6	271	224573-1	271
197474-5	262	198559-0	285	224090-1	271	224577-3	271
197475-3	262	198570-2	157	224111-7	271	256241-8	285
197738-7	260	198642-3	142	224111-9	271	256812-1	272
197804-0	262	198644-9	142	224118-5	271	257022-3	156
197806-6	262	198687-1	273	224119-3	271	257060-5	156
197808-2	261	198688-9	273	224137-1	271	273472-4	274
197810-5	280	198700-5	277	224151-7	271	281220-7	142
197822-8	279	198701-3	277	224160-6	271	302040600N	171
197824-4	279	198702-1	277	224184-2	271	313249-6	218
197828-6	280	198730-6	287	224207-6	271	321308-2	243
197831-7	280	198746-1	287	224223-8	271	321472-9	243
197837-5	279	198748-7	287	224241-6	271	321492-3	242
197840-6	279	198752-6	287	224256-3	271	322119-8	117
197842-2	279	198765-7	260	224257-1	271	322120-3	117
197845-6	279	198859-8	262	224264-4	271	322124-5	117
197847-2	279	198862-9	262	224268-6	271	322125-3	117
197850-3	279	198867-9	285	224274-1	271	322126-1	117
197853-7	280	198873-4	285	224275-9	271	322279-6	116
197859-5	279	198875-0	285	224276-7	271	322312-4	272
197864-2	280	198878-4	285	224280-6	271	322932-4	272
197867-6	280	198880-7	285	224298-7	271	323018-7	243
197870-7	280	198882-3	286	224299-5	271	323726-0	272
197873-1	279	198884-9	157	224303-0	271	325673-1	272
197876-5	279	198901-5	287	224308-0	271	327379-7	275
197879-9	280	198912-0	74	224310-3	271	327380-2	275
197881-2	280	198918-8	286	224333-1	271	332059-2	264
197883-8	280	198921-9	286	224347-0	271	342428-9	243
197886-2	279	198989-5	286	224360-8	271	343355-3	211
197903-8	287	198991-8	286	224366-6	271	343577-5	243
197912-7	213	199037-3	286	224377-1	271	344364-5	243
197914-3	213	199040-4	286	224378-9	271	344443-9	168

346449-3	142	445070455	265	6958011000	268	743328-0	285
346666-5	264	445074452	265	6958018000	268	751101-A	94
351011-000	167	450688-0	142	6958025000	268	751102-A	94
375009-000	290	451208-3	286	711195-A	86	751103-A	93
394369600	235	451240-7	286	711227-A	83	751106-A	94
394369610	235	451243-1	286	711229-A	83	751220-A	93
410306-2	286	451271-6	212	711231-A	83	751221-A	94
410602-8	212	451622-3	212	711234-A	83	751222-A	93
411292-0	117	451623-1	212	711235-A	83	751224-A	92
412010-9	235	453218-6	245	711249-A	83	751225-A	92
412028-0	235	453506-1	264	711252-A	83	751226-A	93
412088-2	235	453507-9	264	711255-A	83	751227-A	93
413068-1	168	453699-4	264	711430-A	86	751420-A	93
415038751	267	453700-5	264	711431-A	86	751421-A	92
415045751	267	456236-3	264	711432-A	86	751422-A	92
415252-4	212	456586-6	286	711433-A	86	751621-A	94
415253-2	245	457228-5	286	711434-A	86	751622-A	94
415887-1	168	458891-7	286	711435-A	86	751623-A	93
415946-1	285	458919-1	286	711437-A	86	751624-A	93
415962-3	287	459056-4	286	711438-A	86	751625-A	95
415965-7	286	465043755	267	711445-A	86	751710-A	93
416041-0	286	523093664	265	711446-A	86	751711-A	93
416256-9	274	523093672	265	711451-A	86	751713-A	93
416299-1	275	528099664	265	711453-A	86	751715-A	95
416311-7	265	528099668	265	7165	281	751716-A	93
416368-8	275	528099672	265	7167	281	751717-A	94
416477-3	168	528099684	265	722100-A	167	752104-A	86
417322-5	275	528099694	265	722101-A	167	752106-A	86
417383-5	142	528099696	265	722102-A	167	752113-A	86
417476-8	142	531492656	265	722103-A	167	752124-A	86
417605-3	142	5929002000	264	725092-5	169	752140-A	86
417615-0	142	6004	271	725093-3	169	752142-A	86
417616-8	142	6249000000	171	725094-1	169	752143-A	86
417630-4	274	6258028002	262	725129-8	169	762007-1	169
418066-0	142	6258060001	262	725130-3	169	762013-6	169
418558-9	235	6258061001	262	725184-0	264	763011-3	74
419360-3	275	630663-4	140	733240-2	242	763062-6	74
421342-3	142	6348001000	262	741402-B	182	763078-1	74
422268-2	287	6348001001	262	741616-9	196	763103-8	74
422437-5	286	638651-5	272	741617-7	196	763161-4	74
423319-4	244	6417014150	264	742137-A	202	763170-3	74
424121-8	275	6418027000	264	742137-A50	202	763174-5	74
442035661	265	6659501100	264	742526-A	202	763178-7	74
443053661	265	6659504000	264	742526-A50	202	763180-0	74
443060-3	286	6908031000	268	742527-A	202	763181-8	74
443122-7	275	6909035001	264	742527-A50	202	763185-0	74
445045455	265	6909039001	268	743015-1	212	763191-5	74
445045651	265	6909093000	171	743025-8	212	763198-1	74
445050455	265	6909500100	268	743033-9	212	763248-2	74
445050455	265	6909511501	264	743036-3	212	763254-7	74
445050651	265	6919500000	268	743052-5	212	763415-9	74
445050655	265	6919500500	264	743081-8	211	763427-2	74
445060455	265	6939025000	268	743081-8	212	763429-8	74
445070455	265	6949001000	268	743327-2	287	763432-9	74

763434-5	74	781206-6	171	794063-3	196	980008213	269
763441-8	74	781213-9	171	794380-1	179	980008217	269
763442-6	74	782016-4	171	794518-8	202	980008265	269
763443-4	74	782021-1	171	794518-8-50	202	980008270	269
763606-2	244	782034-2	171	794519-6	202	980008302	269
763609-6	244	782203-5	171	794519-6-50	202	980008606	269
763610-1	244	782209-3	171	794520-1	202	980008607	269
763620-8	244	782210-8	171	794520-1-50	202	980008610	269
763622-4	244	782212-4	171	794521-9	202	980008611	269
763623-2	244	782401-1	171	794521-9-50	202	988000710	281
763625-8	244	782412-6	171	794522-7	202	988000909	281
763626-6	244	782420-7	171	794522-7-50	202	988000911	281
763629-0	244	782424-9	171	794523-A	202	988002256	269
763637-1	244	782425-7	171	794523-A50	202	988002265	269
763642-8	244	783201-2	171	794544-7	202	988002658	269
763643-6	244	783202-0	171	794558-6	211	988009910	281
763645-2	244	783203-8	171	794560-9	211	988070101	268
763661-4	244	783204-6	171	798029-5	94	988070819	268
763663-0	244	783207-0	171	798139-8	93	988070824	268
763664-8	244	783210-1	171	798140-3	93	A-01323	227
763668-0	244	783223-2	171	798146-1	93	A-07179	227
763674-5	244	784211A250	116	798147-9	93	A-07369(EN)	226
763803-0	244	784217-A	115	8003	271	A-11645	235
763805-6	244	784312A250	116	831271-6	282	A-11667	235
764352-0	125	784607-A	115	831278-2	282	A-11673	235
764353-8	125	784610-A	115	831279-0	282	A-11689	235
764361-9	125	784611-A	115	831342-9	264	A-11704	235
764362-7	125	784612-A	115	832035-1	282	A-11710	235
764363-5	125	784801-1	117	832069-4	282	A-11726	235
764364-3	125	784805-3	117	832071-7	282	A-11748	235
764380-5	125	784811-8	117	832072-5	282	A-11760	235
764381-3	125	784811-8	117	88-1-MK103-L	281	A-11807	235
764382-1	125	791024-4	86	88-1-MK103-M	281	A-15051	169
764383-9	125	791134-7	86	88-1-MK103-XL	281	A-15992	264
764416-0	125	792003-5	163	940827000	171	A-24642	196
764418-6	125	792010-8	152	941713001	264	A-25214	92
764419-4	125	792147-1	164	953003060	266	A-31485	95
764420-9	125	792265-5	169	953003070	266	A-33065	276
766005-7	74	792287-5	169	953003090	266	A-33071	276
766007-3	74	792292-2	169	953003100	266	A-34534	208
766014-6	74	792299-8	152	953004010	266	A-34540	208
766023-5	74	792533-6	169	953100090	266	A-34556	208
766027-7	74	792534-4	169	957250100	267	A-34562	208
7685	281	792536-0	169	957415030	267	A-34578	208
781006-4	171	792537-8	169	957415040	267	A-43670	276
781008-0	171	792559-8	167	957415060	267	A-43686	276
781011-1	171	792728-1	169	957696056	267	A-43692	276
781019-5	171	792742-7	169	957696064	267	A-43701	276
781027-6	171	792743-5	169	980008102	269	A-43717	276
781028-4	171	792744-3	169	980008103	269	A-43723	276
781030-7	171	793011-9	170	980008104	269	A-43739	276
781031-5	171	793015-1	170	980008112	269	A-43773	277
781036-5	171	793346-8	170	980008118	269	A-43795	277
781041-2	171	794060-9	170	980008211	269	A-49563	114

A-49585	114	A-89121	262	A-96322	122	A-96942	112
A-49600	114	A-89143	262	A-96338	122	A-96958	112
A-50120	114	A-89523	262	A-96344	122	A-96964	112
A-50924	114	A-89872-25	194	A-96350	122	A-96970	112
A-51225	142	A-90093	152	A-96366	122	A-96986	112
A-56932	261	A-90451	155	A-96394	122	A-96992	112
A-60551	130	A-90532	154	A-96453	107	A-97003	112
A-60567	130	A-91497-10	209	A-96469	107	A-97019	112
A-60573	130	A-91506-10	209	A-96475	107	A-97025	112
A-60595	130	A-91512-10	209	A-96481	107	A-97031	112
A-60604	130	A-91556-10	210	A-96497	107	A-97047	112
A-60632	130	A-91578-10	211	A-96512	110	A-97053	113
A-80400	160	A-91621-10	210	A-96528	111	A-97069	113
A-80597	94	A-91637-10	210	A-96534	110	A-97075	112
A-80818	91	A-91643-10	210	A-96540	110	A-97081	112
A-81359	152	A-91665-10	209	A-96556	110	A-97097	113
A-81658	262	A-91724-10	211	A-96562	110	A-97106	113
A-83951	169	A-91746-10	210	A-96578	110	A-97112	113
A-84056	232	A-91780-10	210	A-96584	110	A-97128	113
A-84109	228	A-91796-10	210	A-96590	110	A-97134	113
A-84115	228	A-91805-10	210	A-96609	110	A-97140	113
A-84121	228	A-91861-10	209	A-96615	110	A-97156	113
A-84137	228	A-91880-10	209	A-96621	109	A-97162	113
A-84143	232	A-91899-10	209	A-96637	109	A-97178	113
A-84159	232	A-91958-10	209	A-96643	108	A-97184	113
A-84165	232	A-91964-10	209	A-96659	108	A-97190	113
A-84171	232	A-91970-10	210	A-96665	108	A-97209	113
A-85232	160	A-91986-10	210	A-96671-10	108	A-97215	113
A-85400	170	A-92003-10	210	A-96687	108	A-97221	113
A-85628	160	A-92019-10	210	A-96693	111	A-97237	113
A-85640	160	A-92025-10	210	A-96702	111	A-97243	113
A-85656	160	A-92710-5	204	A-96718	111	A-97259	113
A-85662	160	A-92798-5	204	A-96724	110	A-97265	113
A-85678	160	A-92807-5	204	A-96730	110	A-97302-10	107
A-85684	160	A-92835-5	204	A-96746	110	A-97324	107
A-85690	160	A-93887	153	A-96752	110	A-97330-10	111
A-85709	160	A-93893	153	A-96768	110	A-97368	108
A-85715	161	A-93902	153	A-96774	110	A-97380	112
A-85721	162	A-93918	153	A-96780	110	A-97396	112
A-85737	161	A-94530	152	A-96796	109	A-97405-10	111
A-85743	161	A-94736	228	A-96805	109	A-97639	113
A-85759	161	A-95118	152	A-96811	109	A-97645	113
A-85765	162	A-95118	245	A-96827	109	A-97651	113
A-85771	162	A-95506	110	A-96833	109	A-97667	113
A-85787	161	A-95934	150	A-96849	111	A-97673	113
A-85793	160	A-96235	122	A-96855	111	A-97689	113
A-86290	160	A-96241	122	A-96861	111	A-97695	113
A-86321(EN)	226	A-96257	122	A-96877	109	A-98326	113
A-86561	161	A-96263	122	A-96883	109	A-98332	113
A-86577	160	A-96279	122	A-96899	109	A-98348	113
A-86583	160	A-96285	122	A-96908	111	A-98778	152
A-86898	161	A-96291	122	A-96914	109	A-98821	107
A-87694-25	194	A-96300	122	A-96920	112	A-98837	108
A-88490	185	A-96316	122	A-96936	112	A-98843-10	108

A-98859	108	A-99415	113	B-05153	165	B-11433	71
A-98865	108	A-99421	113	B-05153-2	165	B-11449	71
A-98887	111	A-99437	113	B-05153-25	165	B-11455	71
A-98893	111	A-99443	113	B-05169	164	B-11461	71
A-98902	110	A-99459	113	B-05169-2	164	B-11477	71
A-98918	110	A-99465	113	B-05175	164	B-11483	71
A-98924	110	A-99471	113	B-05315	83	B-11499	70
A-98930	110	A-99487	113	B-05337	83	B-11508	70
A-98946	110	A-99493	113	B-05474	83	B-11514	70
A-98952	110	A-99502	113	B-05496	83	B-11520	70
A-98968	110	A-99518	124	B-05636	83	B-11712	71
A-98974	108	A-99524	124	B-05642	83	B-11972	73
A-98980	108	A-99530	124	B-05658	83	B-11988	73
A-98996	108	A-99546	124	B-05767	83	B-12251	190
A-99007	111	A-99552	124	B-06292	161	B-12289	227
A-99013	111	A-99568	124	B-06345	205	B-12289(EN)	226
A-99029	111	A-99574	124	B-06351	205	B-12295	225
A-99041	110	A-99580	124	B-06367	205	B-12295(EN)	226
A-99057	110	A-99596	124	B-06373	205	B-12326	114
A-99063	110	A-99605	124	B-06395	205	B-12441	190
A-99079	110	A-99611	124	B-06404	205	B-12441-10	190
A-99085	110	A-99627	124	B-06410	205	B-12457	190
A-99091	110	A-99633	124	B-06426	205	B-12479	190
A-99100	109	A-99649	124	B-06460	160	B-12479-10	190
A-99116	109	A-99655	124	B-06476	160	B-12500	190
A-99122	109	A-99661	68	B-06482	160	B-12516	190
A-99138	111	A-99677	68	B-06890	162	B-12790	114
A-99144	111	A-99683	68	B-06909	162	B-13459	229
A-99150	111	A-99699	68	B-06921	92	B-13465	229
A-99166	109	A-99708	68	B-07250	166	B-13471	229
A-99172	109	A-99714	68	B-07353	150	B-13817	188
A-99188	109	A-99720	68	B-07375	262	B-14124	261
A-99194	111	A-99736	68	B-07440	150	B-14130	261
A-99203	111	A-99742	68	B-10300	95	B-14146	261
A-99219	111	ADAPTER	264	B-10344	150	B-14526	204
A-99225	109	ADP001G	140	B-10372	89	B-14532	204
A-99231	109	ADP05	142	B-10394	167	B-14548	204
A-99247	109	ADP06	142	B-10403	167	B-14554	204
A-99253	111	ADP08	142	B-10609	166	B-14598-25	194
A-99269	111	B-00804	163	B-10621	89	B-14613	83
A-99275	111	B-00810	162	B-11265	71	B-14629	225
A-99281	112	B-00832	162	B-11271	71	B-15045	83
A-99297	112	B-01971	262	B-11287	71	B-16271	70
A-99306	112	B-02864	170	B-11302	71	B-16667	167
A-99312	112	B-02870	170	B-11324	71	B-16673	167
A-99328	112	B-02951	262	B-11330	71	B-16689	167
A-99334	112	B-03551	152	B-11346	71	B-16695	167
A-99340	112	B-03676	152	B-11352	71	B-16748	232
A-99356	112	B-05038	165	B-11368	71	B-16754	71
A-99362	112	B-05038-2	165	B-11374	71	B-16760	71
A-99378	112	B-05038-25	165	B-11380	71	B-16776-2	166
A-99384	112	B-05044	165	B-11396	71	B-16782	165
A-99390	113	B-05044-2	165	B-11405	71	B-16782-2	165
A-99409	113	B-05044-25	165	B-11411	71	B-16782-25	165

B-16829-2	166	B-19803	154	B-21755	221	B-25317	115
B-16835	165	B-20395	163	B-21761	221	B-25878	115
B-16835-2	165	B-20404	163	B-21777	221	B-25884	115
B-16841-2	166	B-20410	163	B-21783	221	B-25915	115
B-16857-2	166	B-20426	163	B-21799	221	B-26179	115
B-17778	87	B-20432	163	B-21808	221	B-26185	115
B-17865	87	B-20448	163	B-21814	221	B-26191	115
B-17918	87	B-20454	163	B-21820	221	B-26238	116
B-17952	87	B-20482	185	B-21836	114	B-26244	116
B-17980	87	B-20498	185	B-21842	114	B-26250	116
B-18041	83	B-20719	114	B-21858	114	B-26266	115
B-18057	83	B-20725	114	B-21864	114	B-26272	115
B-18188	73	B-20731	114	B-21870	114	B-26288	115
B-18275	185	B-20884	115	B-21886	114	B-26294	116
B-18297	185	B-20890	115	B-21892	114	B-26303	116
B-18306	185	B-20909	115	B-21901	114	B-26319	116
B-18356	185	B-20915	115	B-21917	114	B-26325	116
B-18502	185	B-20921	115	B-21923	114	B-26490	116
B-18524	185	B-20937	115	B-21939	114	B-26515	116
B-18530	185	B-20943	115	B-21945	114	B-26571	116
B-18580	185	B-20959	115	B-22248	166	B-26593	116
B-18605	185	B-20965	115	B-22931	221	B-26642	115
B-19118	152	B-20987	156	B-22947	221	B-26674	54
B-19124	152	B-20993	156	B-22953	221	B-26680	54
B-19130	152	B-21004	156	B-22969	221	B-26733	54
B-19146	151	B-21010	156	B-23145	154	B-26749	54
B-19152	151	B-21026	156	B-23254	166	B-26777	54
B-19168	151	B-21032	156	B-23341	154	B-26783	54
B-19174	151	B-21048	156	B-23385	154	B-26820	54
B-19233	151	B-21054	156	B-23519	115	B-26836	54
B-19249	151	B-21060	156	B-23531	115	B-26842	54
B-19255	151	B-21157	184	B-23547	115	B-26858	54
B-19261	151	B-21163	184	B-23569	115	B-28189	103
B-19364	151	B-21179	184	B-24181	115	B-28195	103
B-19392	152	B-21185	184	B-24197	115	B-28204	103
B-19401	152	B-21191	184	B-24228	115	B-28210	103
B-19417	152	B-21559	221	B-24511	115	B-28226	103
B-19423	152	B-21565	221	B-24527	115	B-28254	103
B-19439	152	B-21571	221	B-24533	115	B-28329	103
B-19445	152	B-21587	221	B-24577	116	B-28357	103
B-19451	152	B-21593	221	B-24583	116	B-28379	103
B-19467	152	B-21602	221	B-24599	116	B-28391	103
B-19489	152	B-21618	221	B-24608	115	B-28416	103
B-19495	152	B-21624	221	B-24614	115	B-28422	103
B-19504	152	B-21630	221	B-24620	115	B-28438	103
B-19510	152	B-21646	221	B-24636	115	B-28444	103
B-19526	152	B-21652	221	B-24658	115	B-28472	103
B-19532	152	B-21674	221	B-24664	115	B-28525	103
B-19548	152	B-21680	221	B-24876	116	B-28531	103
B-19554	152	B-21705	221	B-24898	116	B-28531-24	103
B-19766	153	B-21711	221	B-24957	116	B-28553	103
B-19772	153	B-21727	221	B-24979	116	B-28597	104
B-19788	153	B-21733	221	B-25286	115	B-28709	161
B-19794	154	B-21749	221	B-25301	115	B-28715	161

B-28721	161	B-30754	104	B-36114	71	B-41735	207
B-28896	119	B-31011	60	B-36120	71	B-41741	207
B-28911	119	B-31027	60	B-36136	71	B-41757	207
B-28933	103	B-31033	60	B-36142	71	B-41763	207
B-29511	229	B-31049	60	B-36619	205	B-41779	207
B-29670	71	B-31055	60	B-36631	205	B-41785	207
B-29686	71	B-31061	60	B-36653	205	B-41791	207
B-29692	71	B-31077	60	B-36675	205	B-41800	207
B-29701	71	B-31083	60	B-38071	215	B-41816	207
B-29717	71	B-31099	60	B-38087	215	B-41822	207
B-29723	71	B-31108	60	B-38093	215	B-41872	207
B-29739	71	B-31114	60	B-38124	215	B-41888	207
B-29745	71	B-31120	60	B-38130	215	B-41894	207
B-29751	71	B-31136	60	B-38174	215	B-41903	207
B-29767	71	B-31681	154	B-38180	215	B-41919	207
B-29773	71	B-31728	71	B-38196	215	B-41925	207
B-29789	71	B-31756	71	B-38227	215	B-41931	207
B-29795	71	B-31762	71	B-38233	215	B-41947	207
B-29804	71	B-31778	71	B-38249	215	B-41953	207
B-29810	71	B-31859	164	B-38277	215	B-41969	207
B-29826	71	B-31871	166	B-38320	215	B-41975	207
B-29832	71	B-33912	154	B-38336	215	B-41981	207
B-29848	71	B-33928	154	B-38370	215	B-42438	44
B-29854	71	B-33934	154	B-38386	215	B-42444	44
B-29860	71	B-33940	154	B-38392	215	B-42472	105
B-29876	71	B-33956	154	B-38794	117	B-42494	105
B-29882	71	B-33962	154	B-38803	117	B-42503	105
B-29898	71	B-33978	154	B-38819	117	B-42519	105
B-29907	55	B-34160	205	B-38825	117	B-42575	114
B-29913	55	B-34176	205	B-38831	117	B-42628	153
B-29929	55	B-34198	205	B-38847	122	B-42634	153
B-29935	55	B-34241	205	B-38853	122	B-42961	118
B-29941	55	B-34257	205	B-39263	153	B-42977	118
B-29957	55	B-34263	205	B-39279	153	B-42983	118
B-29963	55	B-34279	205	B-39285	153	B-43000	119
B-29979	55	B-34291	206	B-39291	153	B-43169	164
B-29985	55	B-34300	206	B-39300	203	B-43169-2	164
B-29991	55	B-34316	206	B-39316	203	B-43181-2	166
B-30003	61	B-34366	206	B-39322	203	B-43197	164
B-30019	61	B-34388	206	B-39344	203	B-43197-2	164
B-30025	61	B-34394	206	B-39512-10	105	B-43212-2	166
B-30031	61	B-35433	188	B-39540	105	B-43240	164
B-30047	61	B-35994	71	B-39556	105	B-43256-2	166
B-30053	61	B-36005	71	B-40266	104	B-43262	164
B-30069	61	B-36011	71	B-40347	119	B-43276-2	166
B-30075	61	B-36027	71	B-40353	104	B-43290	118
B-30081	61	B-36033	71	B-40369	104	B-43309	118
B-30097	61	B-36049	71	B-40375	104	B-43315	118
B-30106	61	B-36055	71	B-40381	104	B-43321	118
B-30112	61	B-36061	71	B-40543	167	B-43337	118
B-30128	167	B-36077	71	B-40559	167	B-43343	118
B-30514-25	194	B-36083	71	B-40565	167	B-43359	118
B-30564	166	B-36099	71	B-41713	207	B-43365	118
B-30570	166	B-36108	71	B-41729	207	B-43371	118

B-43387	118	B-48549	226	B-50865	118	B-53039	196
B-44052	183	B-48555	226	B-50871	118	B-53045	196
B-44074	187	B-48561	226	B-51281	154	B-53051	196
B-44080	187	B-48577	226	B-51297	154	B-53067	196
B-44096	188	B-48583	226	B-51312	166	B-53073	196
B-44105	183	B-48599	226	B-51415	204	B-53089	196
B-44111	182	B-48608	226	B-51421	204	B-53095	196
B-44127	187	B-48614	226	B-51437	204	B-53104	196
B-44133	187	B-48620	227	B-51443	204	B-53160	227
B-44155	183	B-48636	226	B-51459	204	B-53176	227
B-44161	182	B-48642	226	B-51465	204	B-53235	149
B-44183	183	B-48658	226	B-51471	204	B-53241	149
B-44199	182	B-48664	227	B-51487	204	B-53687	230
B-44208	187	B-48670	189	B-51493	204	B-53702	230
B-44214	187	B-48686	188	B-51502	204	B-53718	230
B-44236	182	B-48795	118	B-51518	204	B-54081	120
B-44242	187	B-48804	118	B-51524	204	B-54302	267
B-44258	187	B-48810	118	B-51530	204	B-54318	267
B-44264	182	B-48826	118	B-51546	204	B-54324	267
B-44270	182	B-48832	153	B-51552	204	B-54330	267
B-44286	182	B-48848	189	B-51568	204	B-54411	117
B-44292	182	B-48854	189	B-51574	204	B-54461	155
B-44301	182	B-48860	153	B-51580	204	B-54477	155
B-44426	162	B-49373	134	B-51611	118	B-54645	123
B-44432	165	B-49389	132	B-51627	118	B-54651	123
B-44448	165	B-49432	132	B-51661	133	B-54667	123
B-45076	117	B-49507	189	B-51823	235	B-54673	123
B-45082	117	B-49513	189	B-51839	235	B-55304	233
B-45098	117	B-49529	188	B-51845	235	B-55326	233
B-45107	117	B-49535	188	B-51873	117	B-55348	233
B-45375	134	B-49541	188	B-51904	196	B-55603	205
B-45995	72	B-49703	167	B-51910	196	B-55619	205
B-46006	72	B-49719	167	B-51932	196	B-55625	205
B-46012	72	B-49878	185	B-51948	196	B-55631	205
B-46028	72	B-49884	135	B-51954	196	B-55647	205
B-46034	72	B-49890	118	B-51976	196	B-55653	205
B-46040	72	B-49909	118	B-52043	166	B-55669	205
B-46056	72	B-49915	104	B-52071	187	B-55675	205
B-46062	72	B-50005	226	B-52118	165	B-55697	120
B-46078	72	B-50273	133	B-52124	165	B-55734	124
B-46084	72	B-50289	44	B-52130	165	B-55740	124
B-46090	72	B-50310	189	B-52451	117	B-55756	124
B-46109	72	B-50326	189	B-52473	117	B-55815	164
B-46115	72	B-50332	189	B-52691	72	B-55821	164
B-46121	72	B-50348	189	B-52700	72	B-55837	164
B-46137	72	B-50354	189	B-52912-6	105	B-56437	56
B-46327	232	B-50784	118	B-52940	118	B-56524	150
B-46333	232	B-50790	118	B-52962	196	B-56574	150
B-47195	154	B-50809	118	B-52978	196	B-56580	166
B-47204	154	B-50815	118	B-52984	196	B-56596	166
B-47210	154	B-50821	118	B-52990	196	B-56867	149
B-47226	154	B-50837	118	B-53001	196	B-56873	149
B-48527	161	B-50843	118	B-53017	196	B-56889	149
B-48533	226	B-50859	118	B-53023	196	B-56895	149

B-56904	149	B-59449	87	B-60486	188	B-61341	82
B-56910	149	B-59455	87	B-60551	81	B-61357	82
B-56926	149	B-59461	87	B-60567	81	B-61363	82
B-56948	114	B-59477	87	B-60573	81	B-61379	82
B-56954	114	B-59483	87	B-60589	81	B-61385	82
B-57087	149	B-59499	87	B-60595	81	B-61391	82
B-57118-25	194	B-59508	87	B-60604	81	B-61400	82
B-57370	149	B-59514	87	B-60610	81	B-61416	82
B-57386	166	B-59520	87	B-60626	81	B-61422	82
B-57392	166	B-59536	87	B-60632	81	B-61438	82
B-57716	233	B-59542	87	B-60648	81	B-61444	82
B-57722	233	B-59564	87	B-60654	81	B-61450	82
B-57738	123	B-59570	87	B-60660	81	B-61466	82
B-57744	123	B-59586	87	B-60676	81	B-61472	82
B-57750	117	B-59592	87	B-60682	81	B-61488	82
B-57766	117	B-59601	87	B-60698	81	B-61494	82
B-57772	114	B-59617	87	B-60707	81	B-61503	82
B-57788	114	B-59623	87	B-60713	81	B-61519	82
B-57803	114	B-59639	87	B-60729	81	B-61525	82
B-57819	114	B-59645	87	B-60735	81	B-61531	82
B-57825	114	B-59651	87	B-60741	81	B-61547	82
B-57831	114	B-59667	87	B-60757	81	B-61553	82
B-57847	114	B-59673	87	B-60763	81	B-61569	82
B-57853	114	B-59689	87	B-60779	81	B-61575	82
B-57869	114	B-59695	87	B-60785	81	B-61662	81
B-57881	114	B-59704	87	B-60791	81	B-61678	81
B-59106	51	B-59710	87	B-60800	81	B-61684	81
B-59112	51	B-59726	87	B-60816	81	B-61690	81
B-59128	51	B-59732	87	B-60822	81	B-61709	81
B-59134	51	B-59748	87	B-60838	81	B-61715	81
B-59140	51	B-59754	87	B-60844	81	B-61721	81
B-59156	51	B-59760	87	B-60975	85	B-61737	81
B-59162	51	B-59776	87	B-60997	85	B-61743	81
B-59178	51	B-59829	87	B-61008	85	B-61759	81
B-59184	51	B-59835	123	B-61014	85	B-61765	81
B-59190	51	B-59841	123	B-61020	85	B-61771	81
B-59209	51	B-59879	114	B-61036	85	B-61787	81
B-59215	51	B-59885	114	B-61042	85	B-61793	81
B-59221	51	B-59891	114	B-61058	85	B-61802	81
B-59237	51	B-59900	114	B-61064	85	B-61818	81
B-59243	51	B-59916	114	B-61070	85	B-61824	81
B-59259	123	B-59922	114	B-61086	85	B-61830	81
B-59265	122	B-59938	114	B-61092	85	B-61846	81
B-59330	87	B-59944	114	B-61101	85	B-61852	81
B-59346	87	B-59950	114	B-61117	85	B-61868	81
B-59352	87	B-59966	114	B-61123	85	B-61874	81
B-59368	87	B-59972	114	B-61139	85	B-61880	81
B-59374	87	B-59988	114	B-61145	85	B-61896	81
B-59380	87	B-59994	114	B-61151	85	B-61905	81
B-59396	87	B-60006	114	B-61167	85	B-61911	81
B-59405	87	B-60109	262	B-61307	82	B-61927	81
B-59411	87	B-60143	262	B-61313	82	B-61933	81
B-59427	87	B-60399	118	B-61329	82	B-62016	166
B-59433	87	B-60470	188	B-61335	82	B-62038	149

B-62072	135	B-64048	84	B-65165	190	B-65953	43
B-62309	184	B-64054	84	B-65171	190	B-65969	43
B-62315	184	B-64060	84	B-65414	39	B-65975	43
B-62321	184	B-64076	84	B-65420	39	B-65981	43
B-62337	103	B-64082	84	B-65436	39	B-65997	43
B-62343	103	B-64098	84	B-65442	39	B-66014	43
B-62365	103	B-64107	84	B-65458	39	B-66020	43
B-62452	116	B-64113	84	B-65470	39	B-66036	43
B-62468	116	B-64129	84	B-65486	41	B-66042	43
B-63002	149	B-64135	84	B-65492	41	B-66058	43
B-63177	155	B-64141	84	B-65501	41	B-66064	44
B-63563	84	B-64157	84	B-65517	41	B-66070	44
B-63579	84	B-64652	149	B-65523	40	B-66086	44
B-63585	166	B-64727-25	194	B-65539	40	B-66092	44
B-63591	166	B-64727-5	194	B-65545	40	B-66101	44
B-63600	105	B-64749-25	194	B-65551	40	B-66117	44
B-63616	105	B-64755-25	194	B-65567	42	B-66232	124
B-63622	105	B-64799	218	B-65573	42	B-66276	82
B-63638	105	B-64808	218	B-65589	42	B-66282	82
B-63644	105	B-64814	218	B-65595	42	B-66307	84
B-63650	105	B-64820	218	B-65604	42	B-66802	106
B-63666	105	B-64836	218	B-65610	42	B-66824	106
B-63672	105	B-64842	218	B-65626	42	B-66830	106
B-63688	105	B-64858	218	B-65632	41	B-66846	106
B-63694	105	B-64864	218	B-65648	41	B-66852	106
B-63703	105	B-64870	218	B-65654	41	B-66874	106
B-63719	106	B-64886	218	B-65660	41	B-66880	106
B-63725	106	B-64892	218	B-65676	41	B-66933	233
B-63731	106	B-64901	218	B-65682	41	B-66949	233
B-63747	106	B-64917	218	B-65698	41	B-66955	233
B-63753	106	B-64923	218	B-65707	41	B-67387	149
B-63769	106	B-64939	218	B-65713	41	B-67393	149
B-63775	106	B-64945	218	B-65729	41	B-67402	149
B-63781	106	B-64951	218	B-65735	41	B-67418	149
B-63797	106	B-64967	218	B-65741	40	B-67424	149
B-63806	106	B-64973	218	B-65757	40	B-67480	219
B-63812	106	B-64989	218	B-65763	40	B-67496	219
B-63828	82	B-64995	218	B-65779	41	B-67505	219
B-63834	82	B-65006	218	B-65785	41	B-67511	219
B-63840	82	B-65012	219	B-65791	41	B-67795	55
B-63862	82	B-65028	218	B-65800	41	B-68367	183
B-63884	82	B-65034	218	B-65816	41	B-68389	205
B-63890	82	B-65040	218	B-65822	41	B-68395	205
B-63909	82	B-65056	218	B-65838	43	B-68404	205
B-63937	82	B-65062	219	B-65844	41	B-68410	205
B-63943	82	B-65078	219	B-65850	41	B-68426	205
B-63959	86	B-65084	219	B-65866	43	B-68448	123
B-63965	86	B-65090	219	B-65872	43	B-68600	149
B-63971	86	B-65109	219	B-65888	43	B-68937	78
B-63993	84	B-65115	219	B-65894	40	B-68943	78
B-64004	84	B-65121	184	B-65903	43	B-68959	78
B-64010	84	B-65137	184	B-65919	43	B-68965	78
B-64026	84	B-65143	190	B-65931	43	B-68971	78
B-64032	84	B-65159	190	B-65947	43	B-68987	78

B-68993	78	D-00876-25	79	D-01426	249	D-02652	251
B-69004	77	D-00882	78	D-01432	249	D-02668	251
B-69010	77	D-00882-25	79	D-01448	249	D-02680	251
B-69026	77	D-00898	78	D-01507	249	D-02711	251
B-69048	77	D-00898-25	79	D-01513	249	D-02749	252
B-69054	77	D-00907	78	D-01529	249	D-02967	251
B-69060	77	D-00907-25	79	D-01622	249	D-03062	252
B-69076	77	D-00913	79	D-01638	249	D-03084	252
B-69157	104	D-00913-25	79	D-01644	249	D-03090	252
B-69179	104	D-00929	79	D-01650	249	D-03109	252
B-69381	149	D-00929-25	79	D-01672	249	D-03115	252
B-69397	149	D-00935	79	D-01688	249	D-03137	252
B-69406	149	D-00935-25	79	D-01719	250	D-03143	252
B-69412	149	D-00941	79	D-01725	250	D-03171	252
B-69917	135	D-00941-25	79	D-01731	250	D-03187	252
B-80210	264	D-00957	79	D-01747	250	D-03193	252
B-80226	264	D-00957-25	79	D-01753	250	D-03230	252
BL0715	140	D-00963	79	D-01775	250	D-03246	252
BL1014	140	D-00963-25	79	D-01781	250	D-03252	253
BL1016	141	D-00979	79	D-01828	250	D-03377	151
BL1021B	141	D-00979-25	79	D-01840	250	D-03436	150
BL1041B	141	D-00985	79	D-01878	249	D-03464	153
BL1415NA	140	D-00985-25	79	D-01884	249	D-03486	153
BL1430B	140	D-00991	79	D-01909	249	D-03925	151
BL1815G	140	D-00991-25	79	D-01915	249	D-05197-10	227
BL1815N	140	D-01002	79	D-01937	249	D-05212	230
BL1820G	140	D-01002-25	79	D-01943	249	D-07645	170
BL1830B	140	D-01018	79	D-01965	249	D-07951	170
BL1840B	140	D-01018-25	79	D-01987	250	D-07967	170
BL1850B	140	D-01024	79	D-02054	250	D-07973	79
BL1860B	140	D-01024-25	79	D-02076	250	D-08034	91
BL4020	140	D-01030	79	D-02107	250	D-08676	92
BL4025	140	D-01030-25	79	D-02129	250	D-08713	91
BL4040	140	D-01046	79	D-02141	250	D-08729	91
BL4050F	140	D-01046-25	79	D-02163	250	D-08735	91
BL4060B	140	D-01052	79	D-02185	250	D-14093	74
BL4080F	140	D-01052-25	79	D-02191	250	D-15279	94
BR400MP	260	D-01068	79	D-02216	250	D-15285	94
CHUC 05	61	D-01068-25	79	D-02244	250	D-15291	94
D-00804	78	D-01074	79	D-02250	250	D-15300	94
D-00804-25	79	D-01074-25	79	D-02266	250	D-15584	235
D-00810	78	D-01270	249	D-02319	250	D-15590	235
D-00810-25	79	D-01286	249	D-02325	250	D-15609	235
D-00826	78	D-01292	249	D-02347	250	D-15615	235
D-00826-25	79	D-01301	249	D-02397	251	D-15621	235
D-00832	78	D-01317	249	D-02406	251	D-15637	235
D-00832-25	79	D-01323	249	D-02428	251	D-15643	235
D-00848	78	D-01345	249	D-02478	251	D-15659	235
D-00848-25	79	D-01367	249	D-02484	251	D-16346	170
D-00854	78	D-01373	249	D-02509	251	D-16449	58
D-00854-25	79	D-01389	249	D-02537	251	D-16461	255
D-00860	78	D-01395	249	D-02571	251	D-16994	73
D-00860-25	79	D-01404	249	D-02593	251	D-17011	73
D-00876	78	D-01410	249	D-02618	251	D-17033	73

D-17647	93	D-21749	70	D-22464	53	D-23008	57
D-17675	93	D-21755	70	D-22470	53	D-23014	57
D-17681	93	D-21761	70	D-22486	53	D-23020	57
D-18188	182	D-21777	70	D-22492	53	D-23036	57
D-18194	182	D-21783	70	D-22501	53	D-23042	57
D-18194-20	182	D-21799	70	D-22517	53	D-23058	57
D-18203	182	D-21808	70	D-22523	57	D-23064	57
D-18219	182	D-21814	70	D-22539	57	D-23070	57
D-18225	182	D-21820	70	D-22545	57	D-23086	57
D-18231	183	D-21836	70	D-22551	57	D-23092	57
D-18247	183	D-21842	70	D-22567	57	D-23189	66
D-18253	183	D-21864	70	D-22589	57	D-23195	66
D-18275	183	D-21870	73	D-22595	57	D-23204	66
D-18281	183	D-21886	73	D-22604	57	D-23210	66
D-18297	192	D-21945	52	D-22610	57	D-23226	66
D-18306	192	D-21951	52	D-22626	57	D-23232	66
D-18312	192	D-21967	52	D-22632	57	D-23248	66
D-18328	192	D-21973	52	D-22648	57	D-23254	66
D-18334	192	D-21989	52	D-22654	57	D-23260	66
D-18340	192	D-21995	52	D-22660	57	D-23276	66
D-18356	192	D-22006	52	D-22676	57	D-23282	66
D-18362	192	D-22012	52	D-22682	57	D-23298	66
D-18378	192	D-22028	52	D-22698	57	D-23307	66
D-18384	192	D-22034	52	D-22707	57	D-23313	66
D-18390	192	D-22040	52	D-22713	57	D-23329	66
D-18409	192	D-22056	52	D-22729	57	D-23335	66
D-18421	192	D-22062	52	D-22735	57	D-23341	66
D-18437	192	D-22078	52	D-22741	57	D-23357	66
D-19015	91	D-22084	52	D-22757	57	D-23363	66
D-19021	91	D-22096	52	D-22763	57	D-23379	66
D-19059	153	D-22109	52	D-22779	57	D-23385	66
D-19065	153	D-22230	52	D-22785	57	D-23391	67
D-19065-1	153	D-22246	52	D-22791	57	D-23400	67
D-20688	150	D-22252	52	D-22800	57	D-23416	67
D-20725	94	D-22268	52	D-22816	57	D-23422	67
D-20769	55	D-22274	52	D-22822	57	D-23438	67
D-21076	156	D-22280	52	D-22838	57	D-23444	67
D-21347-5	94	D-22296	52	D-22844	57	D-23450	67
D-21353-5	93	D-22305	52	D-22850	57	D-23466	67
D-21369-5	93	D-22311	52	D-22866	57	D-23472	67
D-21521	150	D-22327	52	D-22872	57	D-23488	67
D-21618	70	D-22333	52	D-22888	57	D-23494	67
D-21624	70	D-22349	52	D-22894	57	D-23503	67
D-21630	70	D-22355	52	D-22903	57	D-23519	67
D-21646	70	D-22361	52	D-22919	57	D-23525	67
D-21652	70	D-22377	52	D-22925	231	D-23531	67
D-21668	70	D-22383	52	D-22925	57	D-23547	67
D-21674	70	D-22399	52	D-22931	57	D-23553	67
D-21680	70	D-22408	52	D-22947	57	D-23569	67
D-21696	70	D-22414	52	D-22953	57	D-23575	67
D-21705	70	D-22420	52	D-22969	57	D-23581	67
D-21711	70	D-22436	53	D-22975	57	D-23597	67
D-21727	70	D-22442	53	D-22981	57	D-23606	67
D-21733	70	D-22458	53	D-22997	57	D-23612	67

D-23765	56	D-24636	66	D-31996	206	D-36027	78
D-23868	95	D-24658	66	D-32007	206	D-36033	78
D-23874	56	D-24670	66	D-32013	206	D-36332	235
D-23880	56	D-24907	70	D-32029	206	D-36463	91
D-23896	56	D-24913	70	D-32035	206	D-36479	91
D-23905	56	D-24935	70	D-32041	206	D-36485	91
D-23911	56	D-24941	70	D-32057	206	D-36491	91
D-23927	56	D-24957	70	D-32063	206	D-36516	92
D-23933	56	D-25183	78	D-32079	206	D-36522	92
D-23949	56	D-25199	78	D-32085	206	D-36538	84
D-23955	66	D-25208	78	D-32091	206	D-36544	84
D-23961	66	D-25214	78	D-32100	206	D-36550	84
D-23977	66	D-25220	78	D-32493	206	D-36566	84
D-23983	66	D-25236	78	D-34350	73	D-36572	84
D-23999	66	D-26490	66	D-34366	120	D-36588	84
D-24000	66	D-26509	66	D-34811	94	D-36594	84
D-24016	66	D-26515	178	D-34849	120	D-36603	84
D-24022	66	D-26521	178	D-34877	161	D-36619	84
D-24038	77	D-26537	178	D-34883	161	D-36625	84
D-24044	77	D-26543	178	D-34899	162	D-36631	84
D-24050	77	D-26559	178	D-34908	162	D-36647	84
D-24309	77	D-26571	92	D-35318	55	D-36653	84
D-24315	77	D-26602	92	D-35673	67	D-36669	84
D-24321	77	D-29228	94	D-35689	67	D-36675	84
D-24337	77	D-29935	66	D-35695	67	D-36681	84
D-24343	77	D-29957	66	D-35704	67	D-36697	84
D-24359	77	D-29963	66	D-35710	67	D-36706	84
D-24365	77	D-29979	66	D-35726	67	D-36837	230
D-24365-20	78	D-29985	66	D-35732	67	D-36859	77
D-24371	77	D-29991	66	D-35748	67	D-36865	77
D-24387	77	D-30003	66	D-35754	67	D-36871	77
D-24393	77	D-30019	66	D-35760	67	D-36887	77
D-24402	77	D-30025	66	D-35776	67	D-36893	77
D-24402-20	78	D-30031	66	D-35782	67	D-36902	77
D-24418	77	D-30047	66	D-35798	67	D-36918	77
D-24424	77	D-30112	55	D-35807	67	D-36924	77
D-24430	77	D-30455	77	D-35813	67	D-36930	77
D-24430-20	78	D-30461	77	D-35829	67	D-36946	77
D-24446	77	D-30623	229	D-35835	67	D-36952	77
D-24452	77	D-30639	232	D-35841	67	D-36968	232
D-24468	77	D-31083	119	D-35857	67	D-36980	132
D-24480	77	D-31083-12	119	D-35863	67	D-37029	76
D-24496	77	D-31669	116	D-35879	67	D-37100	76
D-24505	66	D-31697	178	D-35885	67	D-37219	52
D-24511	66	D-31706	178	D-35891	67	D-37348	235
D-24527	66	D-31712	178	D-35900	67	D-37552	228
D-24533	66	D-31728	150	D-35916	67	D-37568	228
D-24549	66	D-31734	80	D-35922	67	D-37574	228
D-24561	66	D-31762	132	D-35938	67	D-37574-10	228
D-24577	66	D-31946	206	D-35944	67	D-37596	232
D-24583	66	D-31952	206	D-35950	67	D-37605	232
D-24599	66	D-31968	206	D-35966	67	D-37611	232
D-24608	66	D-31974	206	D-35972	67	D-37627	232
D-24614	66	D-31980	206	D-35988	67	D-37758	235

D-37764	235	D-40054	59	D-45004	231	D-49258	253
D-38261	228	D-40060	59	D-45456	187	D-49264	253
D-38277	231	D-40076	59	D-45509	174	D-49270	253
D-38504	52	D-40082	59	D-45515	174	D-49286	253
D-38510	52	D-40098	59	D-45521	174	D-49292	253
D-38526	52	D-40107	59	D-45537	174	D-49301	253
D-38532	52	D-40113	59	D-45543	174	D-49317	253
D-38548	52	D-40129	59	D-45559	174	D-49323	253
D-38554	52	D-40135	59	D-45565	174	D-49404	255
D-38560	52	D-40141	60	D-45571	174	D-49410	255
D-38576	52	D-40157	60	D-45587	174	D-49426	255
D-38582	52	D-40163	60	D-45593	174	D-49432	255
D-38598	52	D-40179	60	D-45602	174	D-49448	253
D-38607	52	D-40185	60	D-45618	174	D-49460	253
D-38613	52	D-40191	60	D-45624	174	D-49476	253
D-38629	52	D-40705	231	D-45630	174	D-49482	253
D-38635	52	D-41414	229	D-45646	174	D-49498	256
D-38641	52	D-41436	230	D-45652	174	D-49507	256
D-38657	52	D-41442	230	D-45668	174	D-49513	256
D-38663	52	D-41458	225	D-45674	174	D-49529	254
D-38679	52	D-41464	225	D-45680	174	D-49535	254
D-38685	52	D-42014	133	D-45696	174	D-49541	254
D-38691	52	D-42531	229	D-45705	174	D-49563	254
D-38700	52	D-42553	231	D-45711	174	D-49579	256
D-38716	52	D-42581	232	D-45727	174	D-49694	256
D-38722	52	D-42678	72	D-45733	174	D-49703	256
D-38738	52	D-42684	72	D-45749	174	D-49769	254
D-38744	52	D-42690	72	D-45755	174	D-49775	254
D-38934	155	D-42709	72	D-45761	177	D-49781	254
D-38940	155	D-42721	72	D-45777	177	D-49797	254
D-38956	155	D-42743	72	D-45820	79	D-49806	254
D-39752	179	D-42793	72	D-45836	132	D-49812	254
D-39774	179	D-42824	72	D-47145	134	D-49828	254
D-39796	179	D-42846	72	D-47204	132	D-49840	254
D-39811	179	D-42874	72	D-47248	134	D-49856	254
D-39833	179	D-44258	230	D-49002	253	D-49862	254
D-39855	179	D-44264	230	D-49030	253	D-49878	254
D-39877	179	D-44270	227	D-49052	253	D-49884	254
D-39899	179	D-44270-10	227	D-49068	253	D-49890	256
D-39908	175	D-44286	227	D-49074	253	D-49943	254
D-39914	175	D-44286-10	227	D-49080	253	D-49965	254
D-39920	175	D-44292	227	D-49105	253	D-49971	254
D-39936	175	D-44292-10	227	D-49111	253	D-50049	257
D-39942	175	D-44301	231	D-49127	253	D-50055	257
D-39958	175	D-44317	231	D-49133	253	D-50061	254
D-39964	175	D-44323	231	D-49155	253	D-50077	254
D-39970	175	D-44404	228	D-49177	253	D-50083	254
D-39986	175	D-44410	228	D-49183	255	D-50099	254
D-39992	175	D-44666	73	D-49199	253	D-50158	257
D-40004	175	D-44672	73	D-49208	253	D-50164	257
D-40010	175	D-44694	73	D-49214	253	D-50186	257
D-40026	175	D-44719	73	D-49220	253	D-50192	257
D-40032	175	D-44769	151	D-49236	253	D-50201	257
D-40048	59	D-44775	151	D-49242	253	D-50217	254

D-50223	257	D-51312	150	D-55170	177	D-57168	56
D-50239	257	D-51328	150	D-55186	178	D-57174	57
D-50245	254	D-51340	150	D-55192	178	D-57180	58
D-50251	254	D-51356	150	D-55217	177	D-57196	55
D-50267	254	D-51378	150	D-55223	177	D-57205	55
D-50273	254	D-51384	150	D-55239	178	D-57211	66
D-50289	254	D-51627-25	163	D-55245	177	D-57227	66
D-50295	254	D-51633	163	D-55251	177	D-58497	255
D-50332	72	D-51633-25	163	D-55267	177	D-58506	255
D-50354	72	D-51649	163	D-55273	177	D-58512	253
D-50360	72	D-51661	163	D-55289	177	D-58528	253
D-50376	72	D-52532	92	D-55295	178	D-58534	253
D-50382	72	D-53051	165	D-55304	178	D-58540	253
D-50398	72	D-53089	164	D-55310	177	D-58556	253
D-50413	72	D-53344	255	D-55326	178	D-58562	253
D-50429	72	D-53578	258	D-55332	178	D-58849	44
D-50435	72	D-53584	258	D-55348	177	D-58861	135
D-50441	72	D-53637	80	D-55354	177	D-58877	133
D-50479	58	D-53861	205	D-55360	177	D-58883	230
D-50588	67	D-53877	205	D-55376	177	D-58899	230
D-50594	67	D-53883	205	D-55382	177	D-58908	230
D-50603	67	D-53899	205	D-55398	177	D-58936	199
D-50619	67	D-53908	205	D-55407	177	D-58942	199
D-50625	67	D-53914	205	D-55413	177	D-58958	199
D-50631	67	D-53920	205	D-55429	178	D-58964	199
D-50647	67	D-53936	205	D-55435	178	D-58970	199
D-50653	67	D-53942	205	D-55441	178	D-58986	199
D-50669	67	D-53958	205	D-55457	178	D-58992	199
D-50675	67	D-53964	205	D-55463	178	D-59003	199
D-50681	67	D-53970	205	D-55479	178	D-59025	199
D-50697	67	D-53992	205	D-55485	178	D-59031	199
D-50706	67	D-54003	205	D-55491	178	D-59047	199
D-50712	67	D-54134	201	D-56471	182	D-59053	199
D-50728	67	D-54140	201	D-56518	66	D-59069	199
D-50734	67	D-54156	201	D-56524	66	D-59075	199
D-50871	235	D-54162	201	D-56677	199	D-59097	151
D-50887	235	D-54178	201	D-56683	199	D-59106	150
D-50893	233	D-54184	201	D-56699	199	D-59178	58
D-50902	233	D-54190	201	D-56708	199	D-59184	209
D-51085	231	D-54209	201	D-56714	199	D-59190	209
D-51091	231	D-54287	202	D-56720	199	D-59209	209
D-51100	231	D-54586	202	D-56736	199	D-59215	209
D-51188	72	D-54592	202	D-56742	199	D-59221	209
D-51194	72	D-54601	202	D-56758	199	D-59237	209
D-51203	72	D-54617	202	D-56851	199	D-59243	209
D-51219	72	D-54623	202	D-56982	228	D-59259	209
D-51225	72	D-54651	202	D-56998	228	D-59265	209
D-51231	72	D-54972	95	D-57009	228	D-59271	209
D-51247	72	D-55099	177	D-57071	212	D-59287	209
D-51253	72	D-55108	177	D-57087	212	D-59293	209
D-51269	72	D-55114	177	D-57093	67	D-59302	209
D-51281	73	D-55120	177	D-57102	67	D-59318	209
D-51297	73	D-55136	177	D-57118	67	D-59324	209
D-51306	150	D-55164	177	D-57152	212	D-59330	209

D-59346	211	D-61307	72	D-62636	213	D-63220	258
D-59352	211	D-61313	72	D-62642	213	D-63236	258
D-59368	211	D-61329	72	D-62658	213	D-63242	258
D-59374	211	D-61335	72	D-62664	213	D-63258	258
D-59380	211	D-61341	72	D-62670	213	D-63432	207
D-59396	211	D-61357	72	D-62739	255	D-63448	207
D-59405	211	D-61363	72	D-62745	255	D-63454	207
D-59411	211	D-61379	72	D-62751	255	D-63460	207
D-59427	155	D-61385	72	D-62767	255	D-63476	207
D-60218	53	D-61391	72	D-62773	255	D-63482	207
D-60230	53	D-61400	72	D-62789	255	D-63498	207
D-60252	53	D-61416	72	D-62795	255	D-63507	207
D-60268	53	D-61422	72	D-62804	255	D-63513	207
D-60296	53	D-61438	72	D-62810	255	D-63529	207
D-60305	53	D-61444	72	D-62826	255	D-63535	207
D-60311	53	D-61450	72	D-62832	255	D-63541	207
D-60333	53	D-61466	153	D-62848	255	D-63557	156
D-60349	53	D-61466-10	155	D-62854	255	D-63563	156
D-60355	53	D-61569	93	D-62860	255	D-63579	156
D-60377	53	D-61575	93	D-62876	255	D-63585	156
D-60383	53	D-61581	94	D-62882	255	D-63591	156
D-60414	53	D-61709	118	D-62898	255	D-63616	156
D-60420	53	D-61868	254	D-62907	255	D-63622	156
D-60436	53	D-61896	153	D-62913	255	D-63638	156
D-60442	53	D-61905	153	D-62929	256	D-63644	156
D-60458	53	D-62125	153	D-62935	256	D-63650	156
D-60464	53	D-62234	156	D-62941	256	D-63688	229
D-60470	53	D-62240	156	D-62957	256	D-63747	205
D-60676	225	D-62290	225	D-62963	256	D-63753	205
D-60682	225	D-62315	225	D-62979	256	D-63769	205
D-60698	199	D-62321	225	D-62985	256	D-63775	205
D-60707	199	D-62343	225	D-62991	256	D-63781	205
D-60713	199	D-62359	225	D-63002	256	D-63797	205
D-60729	199	D-62424	90	D-63018	256	D-63806	205
D-60735	199	D-62430	90	D-63024	256	D-63812	205
D-60741	199	D-62446	90	D-63030	256	D-63828	205
D-60757	199	D-62452	150	D-63046	256	D-63834	205
D-60763	199	D-62468	150	D-63052	256	D-63840	205
D-60779	199	D-62474	150	D-63068	256	D-63856	205
D-60785	199	D-62480	150	D-63074	256	D-63862	135
D-60791	199	D-62496	150	D-63080	256	D-63878	156
D-60800	199	D-62505	213	D-63096	256	D-63884	156
D-60816	199	D-62511	213	D-63105	256	D-63965	73
D-60822	199	D-62527	213	D-63111	256	D-63971	73
D-61014	91	D-62533	213	D-63127	256	D-63987	73
D-61210	72	D-62549	213	D-63133	257	D-63993	73
D-61226	72	D-62555	213	D-63149	257	D-64509	53
D-61232	72	D-62561	213	D-63155	257	D-64515	53
D-61248	72	D-62577	213	D-63161	258	D-64521	53
D-61254	72	D-62583	213	D-63177	258	D-64537	53
D-61260	72	D-62599	213	D-63183	258	D-64543	53
D-61276	72	D-62608	213	D-63199	258	D-64559	53
D-61282	72	D-62614	213	D-63208	258	D-64565	53
D-61298	72	D-62620	213	D-63214	258	D-64571	53

D-64587	53	D-65361	201	D-66254	199	D-67359	266
D-64593	53	D-65414	151	D-66260	199	D-67371	266
D-64602	53	D-65420	151	D-66276	199	D-67393	266
D-64618	53	D-65436	151	D-66282	199	D-67418	266
D-64624	53	D-65442	151	D-66298	199	D-67430	266
D-64630	54	D-65501	170	D-66307	199	D-67452	266
D-64646	54	D-65517	114	D-66313	200	D-67474	266
D-64652	54	D-65523	114	D-66329	200	D-67480	266
D-64668	54	D-65539	114	D-66335	200	D-67496	266
D-64674	54	D-65545	114	D-66341	200	D-67608	176
D-64680	54	D-65551	114	D-66357	200	D-68862	245
D-64696	54	D-65713	135	D-66363	200	D-68878	245
D-64705	54	D-65729	176	D-66379	200	D-68884	245
D-64711	54	D-65735	212	D-66385	200	D-68890	245
D-64727	54	D-65816	202	D-66391	200	D-68909	245
D-64733	54	D-65822	202	D-66400	200	D-68915	245
D-64749	54	D-65838	202	D-66416	200	D-68921	245
D-64755	54	D-65844	202	D-66422	200	D-68937	245
D-64761	54	D-65850	202	D-66438	200	D-68943	245
D-64777	54	D-65866	202	D-66444	200	D-68959	245
D-64783	54	D-65872	202	D-66450	200	D-68965	245
D-64799	54	D-65888	202	D-66466	200	D-68971	245
D-64808	54	D-65894	202	D-66472	200	D-68987	245
D-64814	54	D-65903	202	D-66488	199	D-68993	245
D-64820	54	D-65947	192	D-66494	199	D-69004	245
D-64836	54	D-65953	192	D-66503	199	D-69010	245
D-64842	54	D-65969	192	D-66519	199	D-69026	245
D-64858	54	D-65981	261	D-66525	199	D-69032	245
D-64864	54	D-65997	261	D-66531	199	D-69048	245
D-64870	54	D-66008	261	D-66547	199	D-69054	245
D-64886	54	D-66014	261	D-66553	199	D-69060	245
D-64892	54	D-66020	261	D-66569	199	D-69076	245
D-64901	54	D-66036	261	D-66575	78	D-69082	245
D-64917	54	D-66042	261	D-66581	78	D-69098	245
D-64923	54	D-66058	261	D-66606	78	D-69107	245
D-64939	54	D-66064	261	D-66715	225	D-69113	245
D-64945	54	D-66070	176	D-66721	225	D-69129	245
D-64989	135	D-66086	199	D-67000	212	D-69135	245
D-65006	119	D-66092	199	D-67066	208	D-69157	245
D-65028	119	D-66101	199	D-67072	208	D-69163	245
D-65034	93	D-66117	199	D-67088	208	D-69179	245
D-65084	120	D-66123	199	D-67094	208	D-69185	245
D-65109	229	D-66139	199	D-67103	208	D-69191	245
D-65252	200	D-66145	199	D-67119	208	D-69200	245
D-65268	200	D-66151	199	D-67125	208	D-69216	245
D-65274	200	D-66167	199	D-67131	208	D-69222	245
D-65280	200	D-66173	199	D-67147	210	D-69238	246
D-65296	200	D-66189	199	D-67153	210	D-69244	246
D-65305	200	D-66195	199	D-67169	210	D-69250	246
D-65311	201	D-66204	199	D-67175	210	D-69266	246
D-65327	201	D-66210	199	D-67181	210	D-69272	246
D-65333	201	D-66226	199	D-67197	210	D-69288	246
D-65349	201	D-66232	199	D-67206	210	D-69294	246
D-65355	201	D-66248	199	D-67212	210	D-69303	246

D-69319	246	D-69858	247	D-71211	170	D-73564	179
D-69325	246	D-69864	247	D-71227	170	D-73570	179
D-69331	246	D-69870	248	D-71685	191	D-73586	179
D-69347	246	D-69886	248	D-71984	58	D-73592	179
D-69353	246	D-69892	248	D-72023	155	D-73601	176
D-69369	246	D-69901	248	D-72039	155	D-73617	176
D-69375	246	D-69917	248	D-72045	155	D-73623	176
D-69381	246	D-69923	248	D-72051	155	D-73639	176
D-69397	246	D-69939	248	D-72154	266	D-73645	176
D-69406	246	D-69945	248	D-72160	266	D-73651	176
D-69412	246	D-69951	248	D-72176	266	D-73667	176
D-69428	246	D-69967	248	D-72182	266	D-73673	176
D-69434	246	D-69973	248	D-72198	266	D-73689	176
D-69440	246	D-69989	248	D-72207	170	D-73695	176
D-69456	246	D-69995	248	D-72279	153	D-73704	176
D-69462	246	D-70007	248	D-72285	153	D-73710	176
D-69478	246	D-70013	248	D-72394	151	D-73726	176
D-69484	246	D-70029	248	D-72403	151	D-73732	176
D-69490	246	D-70035	248	D-72419	151	D-73748	266
D-69509	246	D-70041	248	D-72425	151	D-73754	266
D-69515	246	D-70057	248	D-72431	151	D-73760	266
D-69521	246	D-70063	248	D-72447	56	D-73776	266
D-69537	246	D-70079	248	D-72475	156	D-73782	266
D-69543	246	D-70085	248	D-72481	156	D-73798	175
D-69559	246	D-70091	249	D-72497	156	D-73807	175
D-69565	246	D-70100	249	D-72506	156	D-73813	175
D-69571	246	D-70116	249	D-72512	156	D-73829	175
D-69587	246	D-70122	249	D-72528	156	D-73835	175
D-69593	246	D-70138	249	D-72534	156	D-73841	175
D-69602	246	D-70144	249	D-72540	156	D-73857	175
D-69618	246	D-70150	249	D-72556	156	D-73863	175
D-69624	247	D-70471	55	D-72562	156	D-73879	261
D-69630	247	D-70742	174	D-72621	238	D-73885	261
D-69646	247	D-70758	174	D-72637	238	D-73891	85
D-69652	247	D-70786	211	D-72671	238	D-73900	85
D-69668	247	D-70792	211	D-72718	162	D-73916	85
D-69674	247	D-70867	212	D-72908	58	D-73922	85
D-69680	247	D-70873	212	D-72914	41	D-73938	85
D-69696	247	D-70889	212	D-73209	68	D-73944	85
D-69705	247	D-70910	170	D-73215	68	D-73950	85
D-69711	247	D-70948	266	D-73221	68	D-73966	85
D-69727	247	D-70954	266	D-73237	68	D-73972	85
D-69733	247	D-70960	266	D-73243	68	D-73988	85
D-69749	247	D-70976	266	D-73259	68	D-73994	85
D-69755	247	D-70982	266	D-73271	119	D-74005	85
D-69761	247	D-70998	266	D-73324	261	D-74011	85
D-69777	247	D-71009	229	D-73455	68	D-74027	85
D-69783	247	D-71015	229	D-73461	121	D-74083	227
D-69799	247	D-71021	229	D-73477	120	D-74099	227
D-69808	247	D-71059	78	D-73508	277	D-74108	227
D-69814	247	D-71065	78	D-73514	277	D-74114	227
D-69820	247	D-71071	78	D-73520	277	D-74120	227
D-69836	247	D-71087	78	D-73536	277	D-74186	206
D-69842	247	D-71205	80	D-73542	277	D-74192	206

D-74201	206	E-00561	98	E-01258	99	E-02711	263
D-74217	206	E-00608	99	E-01270	100	E-02727	263
D-74223	206	E-00614	99	E-01286	99	E-02733	263
D-74239	206	E-00620	99	E-01301	100	E-02749	263
D-74245	206	E-00636	99	E-01317	99	E-02783	263
D-74251	206	E-00642	99	E-01339	100	E-02808	263
D-74267	206	E-00658	99	E-01345	101	E-02814	263
D-74272	206	E-00664	98	E-01351	101	E-02820	263
D-74289	206	E-00670	99	E-01367	101	E-02836	263
D-74295	206	E-00686	99	E-01373	101	E-02842	263
D-74734	135	E-00692	98	E-01389	101	E-02858	263
D-74740	123	E-00701	98	E-01395	101	E-02870	263
D-74762-12	121	E-00717	98	E-01404	101	E-02886	263
D-75437	267	E-00723	99	E-01410	101	E-02892	263
D-75443	267	E-00739	99	E-01426	101	E-02967	229
D-75574	191	E-00745	99	E-01432	101	E-03006	190
D-75580	234	E-00767	98	E-01448	101	E-03121	103
D-75596	234	E-00773	98	E-01454	101	E-03274	103
D-75661-5	234	E-00789	98	E-01460	101	E-03399	103
DA00000169	261	E-00826	100	E-01476	101	E-03420	103
DC10SB	141	E-00832	100	E-01482	101	E-03436	103
DC10WD	141	E-00848	100	E-01498	101	E-03632	70
DC18RC	140	E-00854	100	E-01507	101	E-03648	70
DC18RD	140	E-00860	100	E-01513	101	E-03654	70
DC18RE	140	E-00876	100	E-01529	101	E-03660	70
DC18SD	140	E-00882	98	E-01535	101	E-03676	70
DC18SE	140	E-00898	98	E-01541	101	E-03682	70
DC18SF	140	E-00907	98	E-01579	102	E-03698	70
DC18SH	140	E-00913	98	E-01585	102	E-03707	70
DC18WA	140	E-00929	98	E-01591	102	E-03713	70
DC40RA	140	E-00963	100	E-01600	102	E-03729	70
DC40RB	140	E-00979	100	E-01616	102	E-03741	70
DC40RC	140	E-00985	100	E-01622	102	E-03757	70
DEAWST05	273	E-00991	100	E-01638	102	E-03763	70
DEWST06	273	E-01002	100	E-01644	102	E-03779	70
DML185	144	E-01018	100	E-01650	102	E-03785	70
DML800	144	E-01024	98	E-01666	102	E-03791	70
DML801	143	E-01030	98	E-01672	102	E-03800	70
DML802	144	E-01046	99	E-01688	102	E-03816	70
DML803	144	E-01068	100	E-01694	102	E-03822	70
DML805	144	E-01074	100	E-01703	102	E-03838	70
DML806	144	E-01080	99	E-01747	263	E-03844	70
DML809	144	E-01096	99	E-01775	263	E-03850	70
DML810	137	E-01111	100	E-01781	263	E-03866	70
DML812	144	E-01127	100	E-01806	263	E-03872	70
DML814	143	E-01133	99	E-01812	263	E-03888	70
DML815	144	E-01149	99	E-01834	263	E-03894	70
DML816X	144	E-01155	99	E-01840	263	E-03903	70
E-00022	120	E-01199	100	E-01856	117	E-03919	70
E-00424	240	E-01208	100	E-01862	117	E-03925	70
E-00430	240	E-01214	100	E-01878	117	E-03931	70
E-00446	240	E-01220	100	E-02375	205	E-03947	70
E-00549	98	E-01236	100	E-02381	205	E-03953	70
E-00555	98	E-01242	100	E-02705	263	E-03969	70

E-03975	70	E-05430	37	E-11586	40	K940019032	268
E-03981	70	E-05446	37	E-11592	40	KR400MP	260
E-03997	70	E-05452	37	E-11601	40	KR401MP	260
E-04008	70	E-05468	37	E-11617	40	LE400MP	260
E-04014	70	E-05474	37	E-11623	40	LXRM01	144
E-04020	70	E-05480	37	E-11639	40	ML001G	143
E-04036	70	E-05496	38	E-11645	40	ML002G	143
E-04042	70	E-05505	38	E-11651	40	ML003G	143
E-04058	70	E-05511	38	E-11667	40	ML006GX	143
E-04064	70	E-05527	38	E-11673	40	ML103	144
E-04070	70	E-05533	38	E-11695	234	ML104	144
E-04086	70	E-05549	38	E-11704	234	ML105	144
E-04092	70	E-05555	38	E-11710	234	MUS 1-1/16X	64
E-04101	167	E-05561	38	E-11726	234	MUS 1-1/16X2	64
E-04117	167	E-05577	38	E-11732	234	MUS 1-1/2X1	64
E-04123	167	E-05583	38	E-11748	234	MUS 1-1/2X2	64
E-04933	44	E-05599	38	E-11754	234	MUS 1-1/4X1	64
E-04949	44	E-05608	38	E-11922	133	MUS 1-1/4X2	64
E-04955	44	E-05614	38	E-11944	121	MUS 1-1/8X1	64
E-04977-25	194	E-05620	38	E-11950	121	MUS 1-1/8X2	64
E-05094	34	E-05636	38	E-11966	122	MUS 1-11/16X1	64
E-05103	34	E-05642	38	E-12289	123	MUS 1-11/16X2	64
E-05119	34	E-05658	38	E-12354	122	MUS 1-13/16X1	64
E-05125	34	E-05664	38	E-12996	229	MUS 1-13/16X2	64
E-05131	34	E-05670	38	E-13188	89	MUS 1-15/16X1	64
E-05147	34	E-06616	43	E-13194	89	MUS 1-15/16X2	64
E-05153	34	E-06943	134	E-13275	149	MUS 1-3/16X1	64
E-05169	34	E-07141	82	E-13334	149	MUS 1-3/16X2	64
E-05175	34	E-07157	82	E-13611	267	MUS 1-3/4X1	64
E-05181	34	E-07163	82	E-13627	267	MUS 1-3/4X2	64
E-05197	35	E-07179	82	E-13633	267	MUS 1-3/8X1	64
E-05206	35	E-07185	82	E-13649	267	MUS 1-3/8X2	64
E-05212	35	E-07191	239	E-13655	267	MUS 1-5/16X1	64
E-05228	35	E-07216	239	E-13661	267	MUS 1-5/16X2	64
E-05234	35	E-07294	267	E-15780	73	MUS 1-5/8X1	64
E-05240	35	E-07303	267	E-15796	73	MUS 1-5/8X2	64
E-05256	35	E-07319	267	E-15805	73	MUS 1-7/16X1	64
E-05262	35	E-07325	267	EE400MP	260	MUS 1-7/16X2	64
E-05278	35	E-07331	267	EIB106C	290	MUS 1-7/8X1	64
E-05284	35	E-07397	239	EJ400MP	260	MUS 1-7/8X2	64
E-05290	36	E-08947	151	EM403MP	260	MUS 1-9/16X1	64
E-05309	36	E-08953	151	EN401MP	260	MUS 1-9/16X2	64
E-05315	36	E-10506	44	EN410MP	260	MUS 1/2X1	64
E-05321	36	E-10528	44	EN420MP	260	MUS 1/2X2	64
E-05337	36	E-10534	44	EY401MP	260	MUS 11/16X1	64
E-05343	36	E-10590	135	GM00001714	144	MUS 11/16X2	64
E-05359	36	E-10827-25	193	JM23000065	271	MUS 13/16X1	64
E-05365	36	E-10899	42	JM23000123	290	MUS 13/16X2	64
E-05371	36	E-10908	41	JM23000182	272	MUS 15/16X1	64
E-05387	36	E-10942	44	K000113837	268	MUS 15/16X2	64
E-05393	37	E-11097	169	K000115180	268	MUS 1X1	64
E-05402	37	E-11558	42	K000117864	268	MUS 1X2	64
E-05418	37	E-11564	42	K000118193	268	MUS 2-1/16X1	64
E-05424	37	E-11570	42	K000340781	268	MUS 2-1/16X2	64

MUS 2-1/4X1	64	P-31924	203	P-35841	201	P-37340	210
MUS 2-1/4X2	64	P-31930	203	P-35857	201	P-37356	210
MUS 2-1/8X1	64	P-31946	203	P-35863	201	P-37362	210
MUS 2-1/8X2	64	P-31952	203	P-35879	201	P-37378	210
MUS 2-3/16X1	64	P-31968	203	P-35885	201	P-37471	203
MUS 2-3/16X2	64	P-31974	203	P-36011	201	P-37487	203
MUS 2-3/8X1	64	P-31980	203	P-36027	201	P-37493	203
MUS 2-3/8X2	64	P-31996	203	P-36033	201	P-37502	203
MUS 2-5/16X1	64	P-32007	204	P-36049	201	P-37518	203
MUS 2-5/16X2	64	P-32013	204	P-36675	209	P-37524	203
MUS 2X1	64	P-32574	204	P-36681	209	P-37530	203
MUS 2X2	64	P-32580	204	P-36697	209	P-37546	203
MUS 3/4X1	64	P-32596	204	P-36706	209	P-37552	203
MUS 3/4X2	64	P-32605	204	P-36712	209	P-37568	203
MUS 5/8X1	64	P-32611	204	P-36728	209	P-37574	203
MUS 5/8X2	64	P-32633	204	P-36734	209	P-37580	203
MUS 7/16X1	64	P-32655	204	P-36887	210	P-37596	203
MUS 7/16X2	64	P-32661	204	P-36893	210	P-37605	203
MUS 7/8X1	64	P-32677	204	P-36902	210	P-37611	203
MUS 7/8X2	64	P-32904	200	P-36918	210	P-37627	203
MUS 9/16X1	64	P-32910	200	P-36924	210	P-37633	203
MUS 9/16X2	64	P-32926	200	P-36930	210	P-37649	203
OIL 02	61	P-32932	200	P-36946	210	P-37742	203
P-00088	209	P-32948	201	P-36952	211	P-37758	203
P-00094	209	P-33009	201	P-36968	211	P-37764	203
P-00103	209	P-33015	201	P-36974	211	P-37770	203
P-00119	209	P-33021	201	P-36980	211	P-37786	203
P-00125	209	P-33037	201	P-36996	211	P-37792	203
P-00131	209	P-33043	201	P-37007	211	P-37801	203
P-01199	209	P-33059	201	P-37013	211	P-37817	203
P-01208	209	P-33065	201	P-37091	209	P-37823	203
P-01214	209	P-33071	201	P-37100	209	P-37839	203
P-01220	209	P-33087	200	P-37116	209	P-37845	203
P-01236	209	P-33093	200	P-37122	209	P-37851	203
P-01395	209	P-33102	200	P-37138	209	P-37867	203
P-01404	209	P-33118	200	P-37144	209	P-37873	203
P-04472	179	P-33124	200	P-37150	209	P-37889	203
P-04488	179	P-33130	200	P-37166	209	P-37910	203
P-04494	179	P-33146	200	P-37172	210	P-38118	199
P-08838	244	P-33152	200	P-37188	210	P-38124	199
P-08844	244	P-33168	200	P-37194	210	P-38146	199
P-08850	244	P-33255	221	P-37203	210	P-39431	208
P-21917	84	P-33261	221	P-37219	210	P-39447	208
P-21939	84	P-33277	221	P-37225	210	P-39453	208
P-21973	84	P-33283	221	P-37247	210	P-39469	208
P-31837	201	P-33299	221	P-37253	210	P-39475	208
P-31843	201	P-33308	221	P-37269	210	P-42684	221
P-31859	201	P-33314	221	P-37275	210	P-42690	221
P-31865	201	P-33320	221	P-37281	210	P-42709	221
P-31871	201	P-33336	221	P-37297	210	P-42721	221
P-31887	201	P-35807	201	P-37306	210	P-43206	208
P-31893	201	P-35813	201	P-37312	210	P-43212	208
P-31902	201	P-35829	201	P-37328	210	P-43228	208
P-31918	203	P-35835	201	P-37334	210	P-43234	208

P-43240	208	P-71928	281	SH00000240	287	UPC 21L	63
P-43256	208	P-71978	282	SH00000313	285	UPC 21S	63
P-43262	208	P-72017	282	STEX122385	243	UPC 23L	63
P-43278	208	P-72899	287	STEX122390	244	UPC 23S	63
P-43284	208	P-72942	285	STEXBML360	144	UPC 24L	63
P-43290	208	P-78293	287	SW400MP	260	UPC 24S	63
P-43309	208	P-79843	287	T-01862	268	UPC 26L	63
P-43315	208	P-79859	287	T-01878	268	UPC 26S	63
P-43321	208	P-79865	285	T-01884	268	UPC 27L	63
P-43337	208	P-79946	282	T-01890	268	UPC 27S	63
P-43343	208	P-80874	281	T-01909	268	UPC 29L	63
P-43359	208	P-80880	281	T-01915	268	UPC 29S	63
P-43365	208	P-80896	281	T-01921	268	UPC 31L	63
P-43371	208	P-80905	282	T-01937	268	UPC 31S	63
P-43387	208	P-80949	282	T-01943	268	UPC 32L	63
P-43533	202	P-80999	281	T-01959	268	UPC 32S	63
P-43549	202	P-81000	281	T-01965	268	UPC 34L	63
P-43555	202	P-81343	281	T-01971	268	UPC 34S	63
P-43561	202	P-81371	281	T-01993	179	UPC 35L	63
P-43577	202	P-81474	282	T-02004	179	UPC 35S	63
P-43583	202	P-81480	281	T-02010	179	UPC 37L	63
P-43599	202	P-81739	285	T-02026	179	UPC 37S	63
P-43608	202	P-81745	285	T-02375	262	UPC 38L	63
P-43614	202	PILOT L	61	T-02381	262	UPC 38S	63
P-43620	202	PILOT L12	61	T-02397	262	UPC 40L	63
P-43636	202	PILOT L12L	61	T-02406	262	UPC 40S	63
P-43642	202	PILOT S	61	T-02412	262	UPC 42L	63
P-43658	202	PILOT S12	61	T-02428	262	UPC 42S	63
P-43664	202	PILOT S12S	61	T-02434	262	UPC 43L	63
P-43670	202	PILOT U1A	61	T-02456	281	UPC 43S	63
P-43686	202	PILOT U1B	61	T-02462	281	UPC 45S	63
P-43692	202	PILOT U2A	61	T-02515	268	UPC 46L	63
P-43701	202	PILOT U2B	61	T-02521	268	UPC 46S	63
P-43804	204	PR00000028	277	T-02543	281	UPC 48L	63
P-43810	204	PR00000029	277	T-02559	281	UPC 48S	63
P-43826	204	PR00000030	277	T-02668	213	UPC 50L	63
P-43832	204	PR00000031	277	T-02674	213	UPC 50S	63
P-43848	204	PR00000032	277	T-02680	213	UPC 51L	63
P-43854	204	PR00000033	277	T-02820	74	UPC 51S	63
P-43860	204	PR00000034	277	TG00000004	280	UPC 52S	63
P-43876	204	PR00000035	278	TG00000009	279	UPC 53L	63
P-43882	204	PR00000036	278	TK0LM2000F	142	UPC 54S	63
P-70219	287	PR00000037	278	TP00000199	264	UPC 55L	63
P-70297	287	PR00000038	278	TR00000002	130	UPC 55S	63
P-71417	278	PR00000039	277	UPC 14L	63	UPC 57L	63
P-71423	278	PR00000040	278	UPC 14S	63	UPC 57S	63
P-71495	278	PR00000041	278	UPC 15L	63	UPC 59L	63
P-71504	278	PR00000042	278	UPC 15S	63	UPC 59S	63
P-71548	278	SC00000111	169	UPC 16L	63	UPC 60L	63
P-71554	278	SC00000160	169	UPC 16S	63	UPC 60S	63
P-71803	282	SC00000165	171	UPC 18L	63	US 1-1/16"X1"	62
P-71819	282	SC09003260	169	UPC 18S	63	US 1-1/16"X2"	62
P-71853	281	SH00000065	285	UPC 19L	63	US 1-1/2"X1"	62
P-71875	281	SH00000213	287	UPC 19S	63	US 1-1/2"X2"	62

US 1-1/4"X1"	62
US 1-1/4"X2"	62
US 1-1/8"X1"	62
US 1-1/8"X2"	62
US 1-11/16"X1"	62
US 1-11/16"X2"	62
US 1-13/16"X2"	62
US 1-15/16"X1"	62
US 1-15/16"X2"	62
US 1-3/16"X1"	62
US 1-3/16"X2"	62
US 1-3/4"X1"	62
US 1-3/4"X2"	62
US 1-3/8"X1"	62
US 1-3/8"X2"	62
US 1-5/16"X1"	62
US 1-5/16"X2"	62
US 1-5/8"X1"	62
US 1-5/8"X2"	62
US 1-7/16"X1"	62
US 1-7/16"X2"	62
US 1-7/8"X1"	62
US 1-7/8"X2"	62
US 1-9/16"X1"	62
US 1-9/16"X2"	62
US 1"X1"	62
US 1"X2"	62
US 1/2"X1"	62
US 1/2"X2"	62
US 11/16"X1"	62
US 11/16"X2"	62
US 13/16"X1"	62
US 13/16"X2"	62
US 15/16"X1"	62
US 15/16"X2"	62
US 2"X1"	62
US 2"X2"	62
US 3/4"X1"	62
US 3/4"X2"	62
US 5/8"X1"	62
US 5/8"X2"	62
US 7/16"X1"	62
US 7/16"X2"	62
US 7/8"X1"	62
US 7/8"X2"	62
US 9/16"X1"	62
US 9/16"X2"	62
W107402706	285
W14295	286
W29541	286
W6084	286
XNR0000085	171

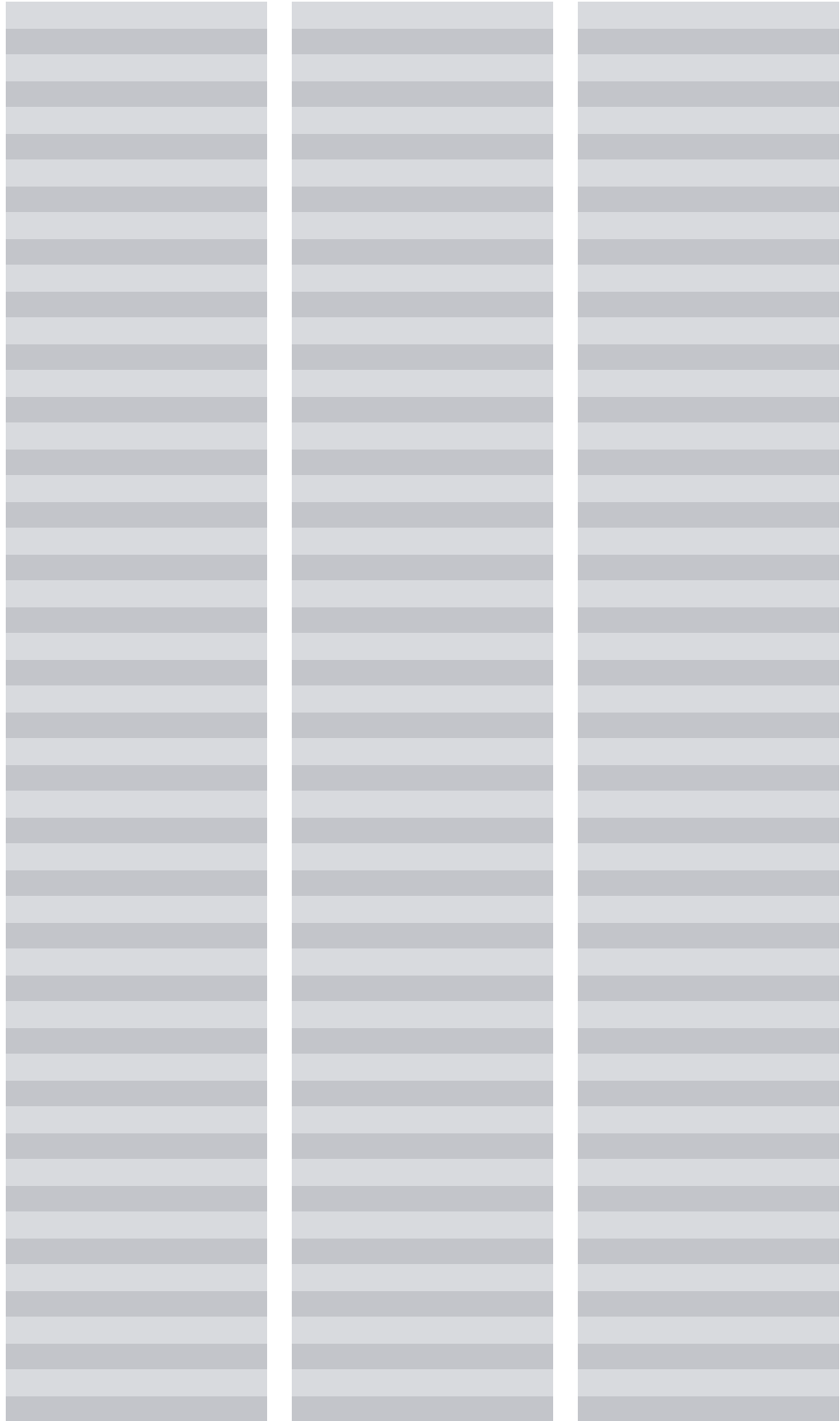

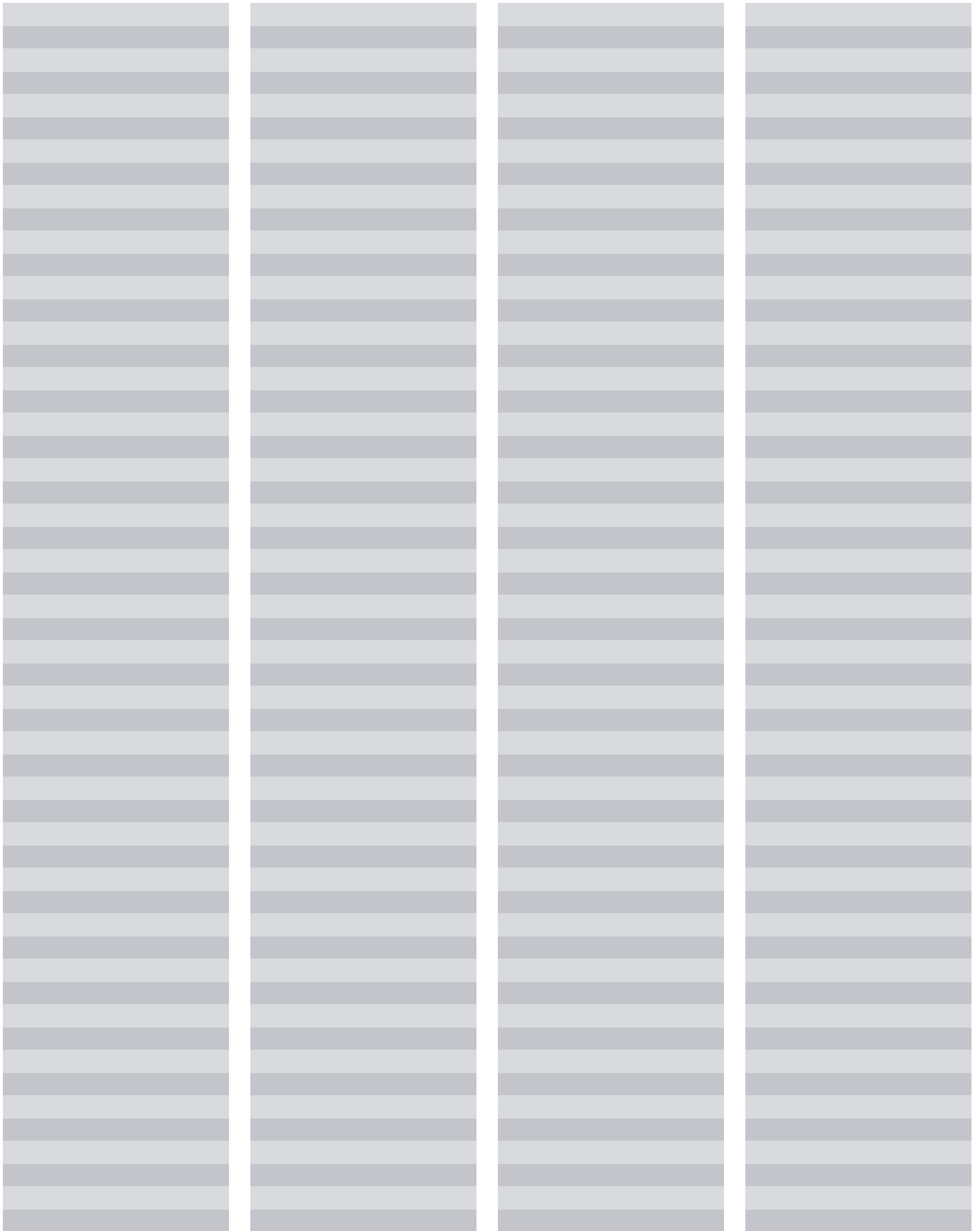

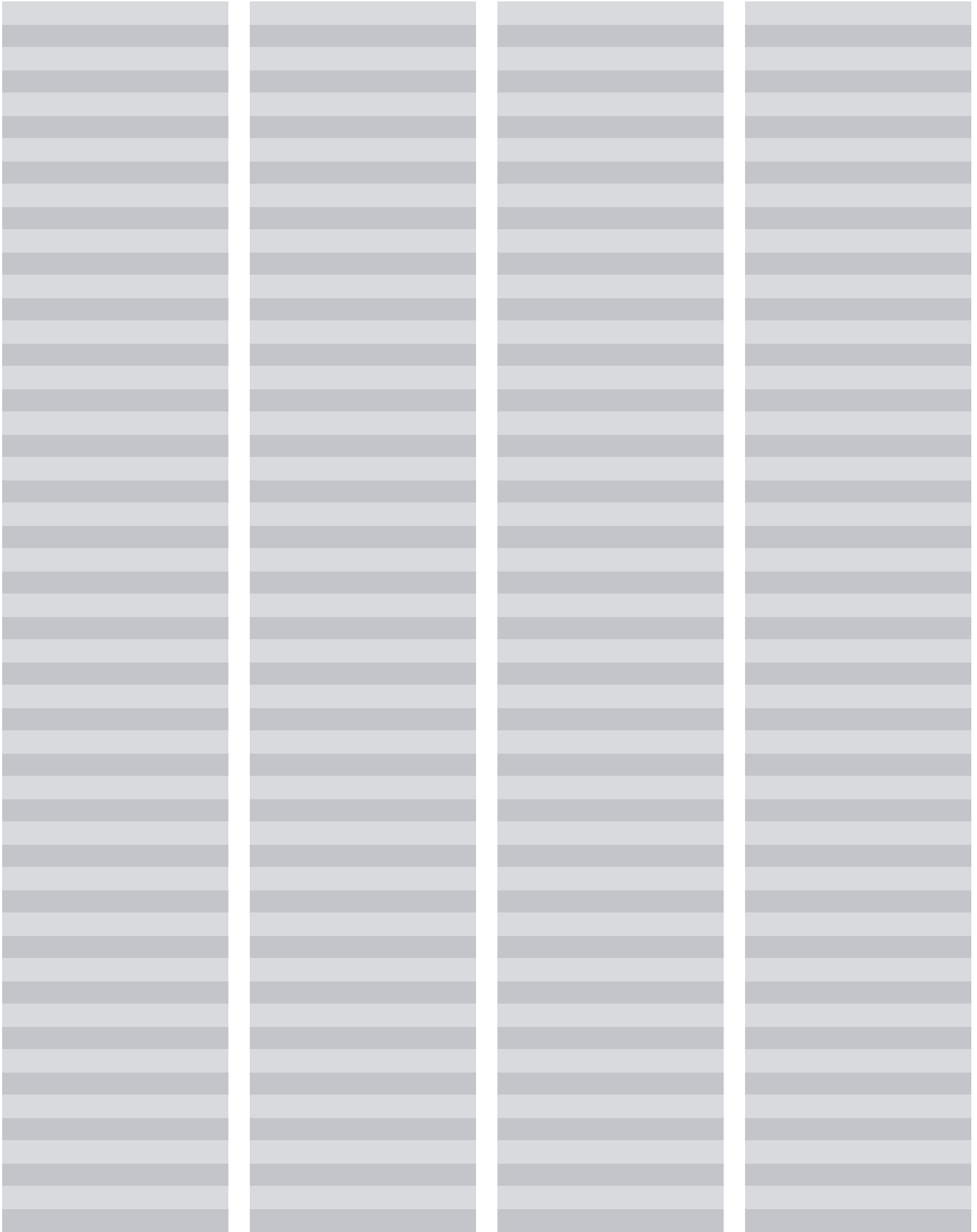



BLUE COLLECTION

Producto	Descripción/Medidas	No. empaque	No. parte
	Funda para taladro MEDIDAS Altura 290 mm 11 3/8 in Longitud 170 mm 6 3/4 in Ancho 85 mm 3 3/8 in Peso 300 g 66 lb Capacidad -	1	E-05094
	Funda para atornillador tipo lápiz MEDIDAS Altura 320 mm 12 5/8 in Longitud 85 mm 3 3/8 in Ancho 60 mm 2 3/8 in Peso 110 g 24 lb Capacidad -	1	E-05103
	Funda para atornillador MEDIDAS Altura 235 mm 9 1/4 in Longitud 155 mm 6 3/8 in Ancho 75 mm 3 in Peso 130 g 29 lb Capacidad -	1	E-05119
	Funda para taladro y porta herramienta MEDIDAS Altura 270 mm 10 5/8 in Longitud 260 mm 10 1/4 in Ancho 145 mm 5 3/4 in Peso 550 g 1.21 lb Capacidad 1.8 lts 0.40 gal	1	E-05125
	Porta pijas con soporte para martillo MEDIDAS Altura 270 mm 10 5/8 in Longitud 260 mm 10 1/4 in Ancho 145 mm 5 3/4 in Peso 510 g 1.12 lb Capacidad 2.6 lts 0.57 gal	1	E-05131
	Porta herramienta con 3 compartimientos MEDIDAS Altura 270 mm 10 5/8 in Longitud 320 mm 12 5/8 in Ancho 145 mm 5 3/4 in Peso 670 g 1.47 lb Capacidad 3.3 lts 0.73 gal	1	E-05147
	Porta herramienta para instaladores MEDIDAS Altura 270 mm 10 5/8 in Longitud 290 mm 11 3/8 in Ancho 145 mm 5 3/4 in Peso 660 g 1.45 lb Capacidad 2.6 lts 0.57 gal	1	E-05153
	Cinturón profesional con 3 compartimientos MEDIDAS Altura 270 mm 10 5/8 in Longitud 640 mm 25 1/4 in Ancho 145 mm 5 3/4 in Peso 1.34 kg 2.95 lb Capacidad 6.5 lts 1.43 gal	1	E-05169
	Cinturón de piel, uso pesado con porta herramientas MEDIDAS Altura 310 mm 12 1/4 in Longitud 880 mm 34 5/8 in Ancho - Peso 1.73 kg 3.81 lb Capacidad 2.78 lts 0.61 gal	1	E-05175
	Porta herramientas profesional para electricistas MEDIDAS Altura 310 mm 12 1/4 in Longitud 250 mm 9 7/8 in Ancho 125 mm 4 7/8 in Peso 550 g 1.21 lb Capacidad 1.7 lts 0.37 gal	1	E-05181







Producto	Descripción/Medidas	No. empaque	No. parte
	Porta clavos con soporte para martillo MEDIDAS Altura 185 mm 7 1/4 in Longitud 180 mm 7 5/8 in Ancho 105 mm 4 1/8 in Peso 250 g 0.55 lb Capacidad 1.2 lts 0.26 gal	1	E-05197
	Porta baterías doble con cierre MEDIDAS Altura 185 mm 7 1/4 in Longitud 175 mm 6 7/8 in Ancho 105 mm 4 3/8 in Peso 240 g 0.53 lb Capacidad 1 lt 0.22 gal	1	E-05206
	Funda para electricistas con 4 compartimentos MEDIDAS Altura 205 mm 8 1/8 in Longitud 185 mm 7 1/4 in Ancho 55 mm 2 1/8 in Peso 280 g 0.62 lb Capacidad -	1	E-05212
	Funda para herramientas y martillo MEDIDAS Altura 205 mm 8 1/8 in Longitud 185 mm 7 1/4 in Ancho 85 mm 3 3/8 in Peso 290 g 0.64 lb Capacidad -	1	E-05228
	Porta martillo lateral MEDIDAS Altura 165 mm 6 1/2 in Longitud 110 mm 4 3/8 in Ancho 70 mm 2 3/4 in Peso 150 g 0.33 lb Capacidad -	1	E-05234
	Porta martillo y hacha MEDIDAS Altura 165 mm 6 1/2 in Longitud 110 mm 4 3/8 in Ancho 65 mm 2 1/2 in Peso 130 g 0.29 lb Capacidad -	1	E-05240
	Clip de uso universal MEDIDAS Altura 165 mm 6 1/2 in Longitud 110 mm 4 3/8 in Ancho 15 mm 5/8 in Peso 9 g 0.2 lb Capacidad -	1	E-05256
	Funda para cuchillo o tijera de podar MEDIDAS Altura 200 mm 7 7/8 in Longitud 100 mm 3 7/8 in Ancho 50 mm 2 in Peso 8 g lb Capacidad -	1	E-05262
	Porta flexómetro MEDIDAS Altura 165 mm 6 1/2 in Longitud 110 mm 4 3/8 in Ancho 5 mm 3/16 in Peso 140 g 0.31 lb Capacidad -	1	E-05278
	Porta cinceles MEDIDAS Altura 270 mm 10 5/8 in Longitud 100 mm 3 7/8 in Ancho 60 mm 2 3/8 in Peso 160 g 0.35 lb Capacidad 0.3 lts 0.07 gal	1	E-05284

El equipo estándar (accesorios), las especificaciones y las fotografías pueden variar. Los accesorios pueden no estar incluidos desde origen con las herramientas, aunque se indiquen en este catálogo.

Producto	Descripción/Medidas			No. empaque	No. parte
	Cinturón y correa para hombro			1	E-05290
MEDIDAS					
Altura	38 mm	1 1/2 in			
Longitud	1300 mm	51 1/8 in			
Ancho	-	-			
Peso	180 g	0.40 lb			
Capacidad	-	-			
	Argolla porta llave			3	E-05309
MEDIDAS					
Altura	129 mm	5 1/8 in			
Longitud	41 mm	1 5/8 in			
Ancho	-	-			
Peso	3 g	0.07 lb			
Capacidad	-	-			
	Argolla porta llave			6	E-05315
MEDIDAS					
Altura	129 mm	5 1/8 in			
Longitud	41 mm	1 5/8 in			
Ancho	-	-			
Peso	3 g	0.07 lb			
Capacidad	-	-			
	Cinturón de piel con soporte acojinado y argolla porta llave			1	E-05321
MEDIDAS					
Altura	100 mm	3 7/8 in			
Longitud	880 mm	34 5/8 in			
Ancho	30 mm	1 1/8 in			
Peso	660 g	1.45 lb			
Capacidad	-	-			
	Cinturón textil con argolla porta llave			1	E-05337
MEDIDAS					
Altura	50 mm	2 in			
Longitud	1550 mm	6 in			
Ancho	-	-			
Peso	250 g	0.55 lb			
Capacidad	-	-			
	Cinturón de piel de uso pesado			1	E-05343
MEDIDAS					
Altura	48 mm	1 7/8 in			
Longitud	1380 mm	54 3/8 in			
Ancho	-	-			
Peso	300 g	0.66 lb			
Capacidad	-	-			
	Cinturón negro de piel (M)			1	E-05359
MEDIDAS					
Altura	38 mm	1 1/2 in			
Longitud	1130 mm	44 1/2 in			
Ancho	-	-			
Peso	200 g	44 lb			
Capacidad	-	-			
	Cinturón negro de piel (G)			1	E-05365
MEDIDAS					
Altura	38 mm	1 1/2 in			
Longitud	1330 mm	51 3/8 in			
Ancho	-	-			
Peso	230 g	0.51 lb			
Capacidad	-	-			
	Cinturón café (M)			1	E-05371
MEDIDAS					
Altura	38 mm	1 1/2 in			
Longitud	1130 mm	44 1/2 in			
Ancho	-	-			
Peso	200 g	0.44 lb			
Capacidad	-	-			
	Cinturón café de piel (G)			1	E-05387
MEDIDAS					
Altura	38 mm	1 1/2 in			
Longitud	1330 mm	51 3/8 in			
Ancho	-	-			
Peso	230 g	0.51 lb			
Capacidad	-	-			



Producto	Descripción/Medidas	No. empaque	No. parte
	Tirante con soporte textil y funda para smartphone MEDIDAS Altura 410 mm 16 1/8 in Longitud 520 mm 20 1/2 in Ancho 23 mm 7/8 in Peso 470 g 1.03 lb Capacidad -	1	E-05393
	Tirante textil con clip MEDIDAS Altura Universal Longitud 50 mm Ancho - Peso 240 g 0.53 lb Capacidad -	1	E-05402

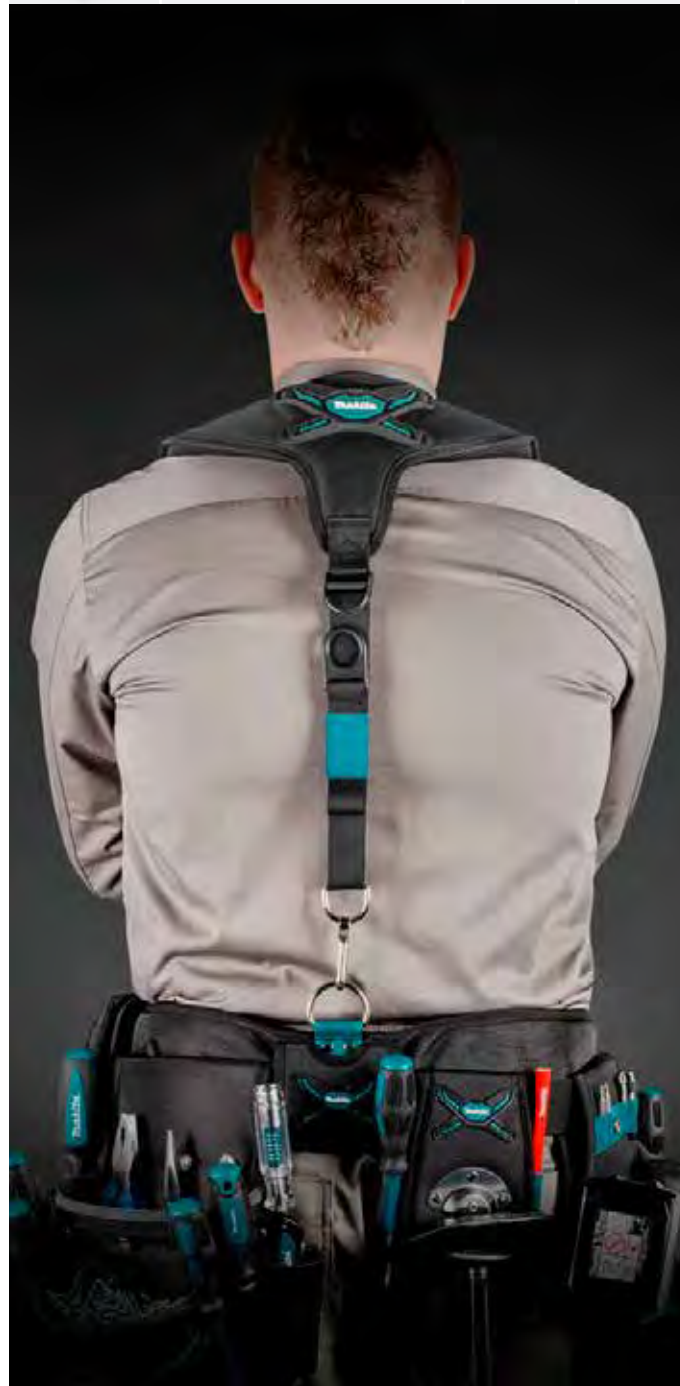

	Caja de 20" para herramientas MEDIDAS Altura 310 mm 12 1/4 in Longitud 510 mm 20 1/8 in Ancho 300 mm 11 3/4 in Peso 3.38 kg 7.44 lb Capacidad 27 lts 5.94 lb	1	E-05418
	Caja reforzada de 19" para herramientas MEDIDAS Altura 265 mm 10 3/8 in Longitud 505 mm 19 7/8 in Ancho 295 mm 11 5/8 in Peso 3.8 kg 8.36 lb Capacidad 32 lts 7.04 gal	1	E-05424
	Maleta abierta para herramientas MEDIDAS Altura 355 mm 14 in Longitud 490 mm 19 1/4 in Ancho 310 mm 12 1/8 in Peso 2.44 kg 5.37 lb Capacidad 29.7 lts 6.53 gal	1	E-05430
	Maleta con cubierta para herramientas MEDIDAS Altura 360 mm 14 1/4 in Longitud 490 mm 19 1/4 in Ancho 310 mm 12 1/8 in Peso 2.72 kg 5.98 lb Capacidad 30.7 lts 6.75 gal	1	E-05446
	Maleta con cierre, tipo compuerta MEDIDAS Altura 280 mm 11 in Longitud 510 mm 20 1/8 in Ancho 295 mm 11 5/8 in Peso 2.18 kg 4.8 lb Capacidad 34.3 lts 7.55 gal	1	E-05452
	Maleta porta herramientas, entrada ancha MEDIDAS Altura 250 mm 9 7/8 in Longitud 440 mm 17 3/8 in Ancho 240 mm 9 1/2 in Peso 1.67 kg 3.67 lb Capacidad 25.8 lts 5.68 gal	1	E-05468
	Mochila porta herramientas con 3 compartimientos MEDIDAS Altura 225 mm 8 7/8 in Longitud 350 mm 13 3/4 in Ancho 175 mm 6 7/8 in Peso 940 g 2.07 lb Capacidad 7 lts 1.54 gal	1	E-05474
	Bolsa multifuncional con 4 compartimientos laterales MEDIDAS Altura 410 mm 16 1/8 in Longitud 260 mm 10 1/4 in Ancho 220 mm 8 5/8 in Peso 1.09 g 2.4 lb Capacidad 10 lts 2.2 gal	1	E-05480

El equipo estándar (accesorios), las especificaciones y las fotografías pueden variar. Los accesorios pueden no estar incluidos desde origen con las herramientas, aunque se indiquen en este catálogo.

Producto	Descripción/Medidas	No. empaque	No. parte	Producto	Descripción/Medidas	No. empaque	No. parte
	Maleta semi rígida para herramientas MEDIDAS Altura 270 mm 10 5/8 in Longitud 520 mm 20 1/2 in Ancho 250 mm 9 7/8 in Peso 1.17 kg 3.89 lb Capacidad 33 lts 7.26 gal	1	E-05496		Funda para smartphone MEDIDAS Altura 165 mm 6 3/4 in Longitud 90 mm 3 1/2 in Ancho 40 mm 1 5/8 in Peso 0.12 kg 0.26 lb	1	E-05583
	Mochila para LapTop MEDIDAS Altura 350 mm 13 3/4 in Longitud 425 mm 16 3/4 in Ancho 170 mm 6 3/4 in Peso 2.49 kg 5.48 lb Capacidad 20 lts 4.4 gal	1	E-05505		Porta termo MEDIDAS Altura 200 mm 7 7/8 in Longitud 90 mm 3 1/2 in Ancho 85 mm 3 3/8 in Peso 0.40 kg 0.88 lb Capacidad 0.35 lts 0.08 gal	1	E-05599
	Mochila organizadora para herramientas MEDIDAS Altura 490 mm 19 1/4 in Longitud 390 mm 15 3/8 in Ancho 230 mm 9 in Peso 2.56 kg 5.63 lb Capacidad 22.3 lts 4.91 gal	1	E-05511		Porta vaso térmico MEDIDAS Altura 175 mm 6 7/8 in Longitud 125 mm 4 7/8 in Ancho 100 mm 3 7/8 in Peso 0.22 kg 0.48 lb Capacidad 0.40 lts 0.09 gal	1	E-05608
	Cubeta organizadora de herramientas MEDIDAS Altura 320 mm 3 7/8 in Longitud 470 mm 34 5/8 in Ancho - Peso 680 g 1.5 lb Capacidad 3.2 lts 0.7 gal	1	E-05527		Lonchera MEDIDAS Altura 210 mm 8 1/4 in Longitud 330 mm 13 in Ancho 180 mm 7 1/8 in Peso 0.45 kg 0.99 lb Capacidad 7.5 lts 1.65 gal	1	E-05614
	Organizador de herramientas MEDIDAS Altura 195 mm 7 5/8 in Longitud 350 mm 13 3/4 in Ancho 45 mm 1 3/4 in Peso 750 g 1.65 lb Capacidad 2 lts 0.44 gal	1	E-05533		Lonchera con correa MEDIDAS Altura 230 mm 9 in Longitud 330 mm 13 in Ancho 200 mm 7 7/8 in Peso 0.87 kg 1.91 lb Capacidad 8.5 lts 1.87 gal	1	E-05620
	Maleta para motosierras MEDIDAS Altura 260 mm 10 1/4 in Longitud 900 mm 35 3/8 in Ancho 270 mm 10 5/8 in Peso 1.72 kg 3.78 lb Capacidad 34.4 lts 7.57 gal	1	E-05549		Chaleco profesional de trabajo MEDIDAS Altura 640 mm 25 1/4 in Longitud 510 mm 20 1/8 in Ancho - Peso 0.81 kg 1.78 lb Capacidad -	1	E-05636
	Mochila enrollable MEDIDAS Altura 400 mm 15 3/4 in Longitud 330 mm 13 in Ancho 200 mm 7 7/8 in Peso 1.24 kg 2.73 lb Capacidad 14 lts 3.08 gal	1	E-05555		Juego de rodilleras MEDIDAS Altura 240 mm 9 1/2 in Longitud 170 mm 6 3/4 in Ancho 30 mm 1 1/8 in Peso 0.28 kg 0.62 lb Capacidad -	1	E-05642
	Bolsa tipo tubo enrollable MEDIDAS Altura 600 mm 23 5/8 in Longitud 320 mm 12 5/8 in Ancho 320 mm 12 5/8 in Peso 1.3 kg 2.86 lb Capacidad 35 lts 7.7 gal	1	E-05561		Rodilleras de gel (uso industrial) MEDIDAS Altura 240 mm 9 1/2 in Longitud 170 mm 6 3/4 in Ancho 95 mm 3 3/4 in Peso 0.52 kg 1.14 lb Capacidad -	1	E-05658
	Maleta de lona, enrollable MEDIDAS Altura 250 mm 9 7/8 in Longitud 610 mm 24 in Ancho 300 mm 11 3/4 in Peso 1.72 kg 3.78 lb Capacidad 37 lts 8.14 gal	1	E-05577		Funda para guía 1.4m / 1.5m MEDIDAS Altura 220 mm 8 5/8 in Longitud 1565 mm 61 5/8 in Ancho 45 mm 1 3/4 in Peso 1.45 kg 3.78 lb Capacidad -	1	E-05664
					Funda de transporte para guía de 1m MEDIDAS Altura 220 mm 8 5/8 in Longitud 1070 mm 42 1/8 in Ancho 45 mm 1 3/4 in Peso 1.11 kg 2.44 lb Capacidad -	1	E-05670



HERRAMIENTA MANUAL

Conoce nuestra línea de herramientas manuales

El complemento ideal para tus herramientas eléctricas ya que las puedes utilizar en cualquier sitio de trabajo

Llave ajustable

El diseño de la entrada hexagonal impide el deslizamiento de la tuerca



Mango más ancho que proporciona mayor comodidad a la mano

Escala en sistema métrico y SAE que permite ajustes rápidos y fáciles

Tamaño (mm)	Capacidad de apertura	Empaque Piezas	No. Parte
6" (150mm)	29 mm	1	B-65414
8" (200mm)	32 mm	1	B-65420
10" (250mm)	36 mm	1	B-65436
12" (300mm)	41 mm	1	B-65442

Juego de llave ajustable

11 piezas



Escala en sistema métrico y SAE que permite ajustes rápidos y fáciles

Patrón de dientes en ángulo en el lado de la mandíbula de la llave proporciona una fuerza de agarre adicional

Contiene	Tamaño (mm)	Empaque Piezas	No. Parte
10 pzs. dados 3/8"	3/8" (10mm), 7/16" (11mm), 15/32" (12mm) 1/2" (13mm), 9/16" (14mm), 19/32" (15mm) 5/8" (16mm), 11/16" (17mm), 23/32" (18mm) 3/4" (19mm)	11	B-65458
1pz llave inglesa ajustable	200mm		

Llave de presión ajustable



Con dientes ranurados que permiten mayor agarre

Tamaño	Tamaño máximo de apertura	Empaque Piezas	No. Parte
10" (250mm)	35mm	1	B-65470

El equipo estándar (accesorios), las especificaciones y las fotografías pueden variar. Los accesorios pueden no estar incluidos desde origen con las herramientas, aunque se indiquen en este catálogo.

Juego milimétrico de llaves abocinadas

5 piezas

* Acero aleado para mayor durabilidad
* Pulido niquelado / cromado para larga duración



Tamaño	Empaque Piezas	No. Parte
9x11mm, 10x12mm, 13x14mm, 15x17mm, 16x18mm	5	B-65545

Juego milimétrico de llaves de estrías

5 piezas



Extremos con ángulos a 75° que permiten trabajar en espacios reducidos



* Acero aleado para mayor durabilidad
* Pulido niquelado / cromado para larga duración

Tamaño	Empaque Piezas	No. Parte
8x9mm, 10x11mm, 12x13mm, 14x15mm, 18x19mm	5	B-65551

Juego milimétrico de llaves combinadas c/ matraca

8 piezas



Resorte que permite un mejor agarre de las tuercas



Tamaño	Empaque Piezas	No. Parte
8mm, 10mm, 12mm, 13mm, 14mm, 15mm, 17mm, 19mm	8	B-65523

Juego milimétrico de llaves combinadas

9 piezas

Proporciona un agarre más fuerte de las tuercas
Reduce el barrido de las tuercas



Tamaño	Empaque Piezas	No. Parte
8mm, 10mm, 12mm, 13mm, 14mm, 15mm, 16mm, 17mm, 18mm	9	B-65539

Llaves combinadas

Medida: milímetros

NUEVO



Tamaño	Empaque Piezas	No. Parte
8mm	1	E-11586
10mm	1	E-11592
12mm	1	E-11601
13mm	1	E-11617
14mm	1	E-11623
15mm	1	E-11639
16mm	1	E-11645
17mm	1	E-11651
18mm	1	E-11667
19mm	1	E-11673

Juego de llaves hexagonales

9 piezas

Punta de bolita para lugares confinados, que permite fijar la pieza en un ángulo máximo de 25°



Con clip que permite ajustar al pantalón

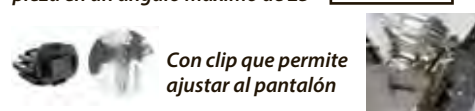

Tamaño	Empaque Piezas	No. Parte
1.5mm, 2mm, 2.5mm, 3mm, 4mm, 5mm, 6mm, 8mm, 10mm	9	B-65894



Llave de mordaza ajustable



Tamaño	Tamaño máximo de agarre	Empaque Piezas	No. Parte
7" (180mm)	37mm	1	B-65741
9.5" (240mm)	49mm	1	B-65757
12" (300mm)	68mm	1	B-65763

Llave de mordaza estándar ajustable



Tamaño	Tamaño máximo de agarre	Empaque Piezas	No. Parte
10" (250mm)	51mm	1	B-65486
12" (300mm)	76mm	1	B-65492

Martillo de uña anti-vibración



Peso	Empaque Piezas	No. Parte
20 oz (567gr.)	1	B-65779

Tijeras de aviador



Tipo de corte	Capacidad de corte		Empaque Piezas	No. Parte
	Acero laminado	Acero inoxidable		
Recto	Calibre 18	Calibre 23	1	B-65791
Izquierdo	Calibre 18	Calibre 23	1	B-65800
Derecho	Calibre 18	Calibre 23	1	B-65816
Bull dog	Calibre 16	Calibre 18	1	B-65822

Navajas



La hoja se pliega de forma segura en el mango para un tamaño compacto y fácil almacenamiento

Descripción	Empaque Piezas	No. Parte
Navaja retráctil de uso rudo	1	B-65785
Navaja plegable retráctil de cambio rápido	1	B-65501 / E-10908
Repuestos de cuchillas para B-65501	10	B-65517

Rastrillo para lechada

NUEVO



Descripción	Hoja	Tamaño de hoja (mm)	Empaque Piezas	No. Parte
Rastrillo para lechada con mango antideslizante	Carburo de tungsteno (2pzs)	50x2mm	1 mango 2 navajas	D-72914

Dados, extensiones y adaptadores



Descripción	Empaque Piezas	No. Parte
Extensión 75mm	1	B-65632
Dado adaptador 1/4"	1	B-65844
Dado adaptador 3/8"	1	B-65850
Dado 10mm	1	B-65648
Dado 11mm	1	B-65654
Dado 12mm	1	B-65660
Dado 13mm	1	B-65676
Dado 14mm	1	B-65682
Dado 15mm	1	B-65698
Dado 16mm	1	B-65707
Dado 17mm	1	B-65713
Dado 18mm	1	B-65729
Dado 19mm	1	B-65735

Matraca



Descripción	Empaque Piezas	No. Parte
Matraca flexible	1	B-65626
Matraca recta	1	B-65610

Matraca



Descripción	Empaque Piezas	No. Parte
Matraca 1/4" SQ, 84T	1	E-11558
Matraca 3/8" SQ, 84T	1	E-11564
Matraca 1/2" SQ, 84T	1	E-11570

Juego milimétrico de dados y matraca

Palanca empotrada que permite acceder a espacios reducidos

Diseño de cabeza cerrada que impide se filtre el polvo

Proporciona un agarre más fuerte de las tuercas, reduciendo el barrido de las mismas



Contenido	Empaque Piezas	No. Parte
Matraca de 1/4" SQ, Puntas T: (T8, T10, T15, T20, T25, T27, T30, T40 x25mm) Dados de 1/4" (5mm, 6mm, 7mm, 8mm, 9mm, 10mm, 11mm, 12mm, 13mm) Conectores hembra SQ de 1/4" (4mm, 4.5mm, 5mm, 5.5mm, 6mm, 7mm, 8mm, 9mm, 10mm, 11mm, 12mm, 13mm) Extensión de dado SQ de 1/4" (3", 6") Adaptador de puntas 1/4" Barra deslizante en T	34	B-65567
Matraca de 3/8" SQ, Adaptador de 3/8" a 1/2" SQ Dados de 3/8" (8mm, 9mm, 10mm, 11mm, 12mm, 13mm, 14mm, 15mm, 16mm, 17mm, 18mm, 19mm, 20mm) Dados intermedios SQ de 3/8" (8mm, 10mm, 13mm, 16mm, 17mm, 19mm) Extensión de dado SQ de 3/8" (3", 6")	23	B-65573
Matraca de 1/2" SQ, Adaptador de 1/2" a 3/8" SQ Dados de 1/2" (10mm, 11mm, 12mm, 13mm, 14mm, 15mm, 16mm, 17mm, 18mm, 19mm, 20mm, 21mm, 22mm, 23mm, 24mm, 27mm, 30mm, 32mm) Extensión de dado SQ de 1/2" (5", 10") Junta universal SQ de 1/2"	23	B-65589

Juegos de dados y matraca

Contenido	Empaque Piezas	No. Parte
Juego milimétrico Dados 10mm, 11mm, 12mm, 13mm, 14mm, 15mm, 16mm, 17mm, 18mm, 19mm. Dado adaptador 1/4", 3/8" Extensión 75mm. Matraca	14	B-65595
Juego molimétrico y estandar Dados 10mm, 11mm, 12mm, 13mm, 14mm, 15mm, 16mm, 17mm, 18mm, 19mm. Dados 3/8", 7/16", 1/2", 9/16", 5/8", 11/16", 3/4" Dado adaptador 1/4", 3/8" Extensión 75mm. Matraca	21	B-65604

Juegos de herramienta manual

Diseñado para satisfacer las necesidades de trabajadores mecánicos, trabajadores de la construcción, reparadores, usuarios de bricolaje, etc.

NUEVO

No. Parte **E-10899**



Contenido	Empaque Piezas	No. Parte
Matraca de 3/8" SQ Atornillador manual, entrada 1/4" Sq cutter co navajas de repuesto Desarmador 1/4" Hex Martillo (7" longitud) Alicate combinado (6" longitud) Alicate de punta larga (6" longitud) Junta universal (1/4", 3/8") Dados de 3/8" (8mm, 9mm, 10mm, 11mm, 12mm, 13mm, 14mm, 15mm, 16mm, 17mm, 18mm, 19mm, 20mm, 21mm) Conectores hembra de 1/4" (4mm, 5mm, 6mm, 7mm, 8mm) Conectores hembra de 3/8" (10mm, 11mm, 12mm, 14mm, 16mm) Adaptador de dado 3/8" a 1/4" Adaptador de dado 3/8" a 1/2" Extensión de dado 3/8" (75mm, 150mm) Guía buscadora 1/4" Hex (5mm, 6mm, 7mm, 8mm, 9mm, 10mm, 11mm) guía buscadora magnética 1/4" Puntas: PH1, PH2, PH3 x25mm T8, T9, T10, T15, T20, T25, T27, T30, T40 x25mm T8H, T9H, T10H, T15H, T20H, T25H, T27H, T30H, T40H SL0.5x3.0, SL0.8x4.0, SL0.8x5.0, SL1.0x5.5, SL1.0x6.0	76	E-10899

Juegos de herramienta manual

120 piezas

Diseñado para satisfacer las necesidades de trabajadores mecánicos, trabajadores de la construcción, reparadores, usuarios de bricolaje, etc.



No. Parte **E-06616**

NUEVO

Contenido	Empaque Piezas	No. Parte
Matraca de 3/8"	120	E-06616
Dados 1/4" Hex 25mm (4, 4.5, 5, 5.5, 6, 7, 8, 9, 10, 11, 12, 13, 14mm)		
Dados 3/8" Hex 28mm (8, 9, 10, 11, 12, 13, 14, 15, 16mm)		
Dados 3/8" Hex 30mm (17, 18, 19, 20, 21mm)		
Dados 1/4" T 25mm (4mm, 5mm, 6mm, 7mm, 8mm)		
Dados 3/8" T 28mm (10mm, 11mm, 12mm, 14mm, 16mm) 30mm (18mm)		
Adaptador de dado 3/8" a 1/4"		
Adaptador de dado 3/8" a 1/2"		
Enchufe para bujía 1/2" Hex (16mm, 21mm)		
Junta universal (1/4", 3/8")		
Extensión de dado 3/8" (75mm, 150mm)		
Extensión de dado 1/4" (50mm, 100mm)		
Llaves combinadas (8, 10, 11, 12, 13, 14, 15mm) X2		
Atornillador manual 1/4"		
Llave Hexagonal (1.5, 2, 2.5, 3, 4, 5, 6, 8mm)		
Cople 1/4"		
Adaptador para dado 1/4", 3/8"		
Adaptador magnético 1/4"		
Guía buscadora 1/4" Hex (80, 120mm)		
Puntas: PH0, PH1, PH2, PH3 x25mm // PZ0, PZ1, PZ2, PZ3 X 25mm T8, T9, T10, T15, T20, T25, T27, T30, T40 x25mm T8H, T9H, T10H, T15H, T20H, T25H, T27H, T30H, T40H x 25mm H3H, H4H, H5H, H6H x25mm SL0.5x3.0, SL0.8x4.0, SL0.8x5.0, SL1.0x5.5, SL1.0x6.0		

Juego métrico de tarraja y machuelos

40 piezas



Descripción	Empaque Piezas	No. Parte
Llave en "T" pequeña y mediana, Adaptador para machuelos pequeño y mediano Adaptador Hexagonal mediano para tarraja Desatornillador Dados hexagonales	40	B-65838

Maneral recto con matraca

1 pieza

No. Parte **B-65866**



Adaptador para machuelos

1 pieza

No. Parte **B-65872**



Adaptador twist para tarraja

NUEVO

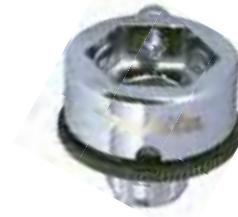

Descripción	Empaque Piezas	No. Parte
Adaptador twist para tarraja	1	B-65888

Desarmador

NUEVO

Mango ergonómico y anti-deslizante que brinda mayor comodidad al usuario y es resistente al aceite

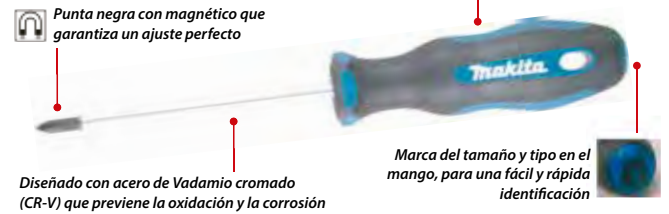

Descripción	Empaque Piezas	No. Parte
Desarmador PH1 (#1x100)	1	B-65903
Desarmador PH2 (#2x100)	1	B-65919
Desarmador PH3 (#3x150)	1	B-65931
Desarmador PZ1 (#1x80)	1	B-65947
Desarmador PZ2 (#2x100)	1	B-65953
Desarmador PZ3 (#3x150)	1	B-65969
Desarmador T10x100	1	B-65975
Desarmador T15x100	1	B-65981
Desarmador T20x100	1	B-65997
Desarmador T25x100	1	B-66008
Desarmador T30x100	1	B-66014
Desarmador plano 4x100	1	B-66020
Desarmador plano 5.5x100	1	B-66036
Desarmador plano 6.5x125	1	B-66042
Desarmador plano 8x150	1	B-66058



Juego de desarmadores

NUEVO

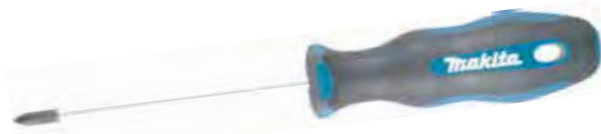

Descripción	Empaque Piezas	No. Parte
Desarmador plano (4pzs) Desarmador PH (2pzs)	6	E-10506
Desarmador plano (2pzs) Desarmador PH (2pzs) Desarmador PZ (2pzs)	6	E-10528
Desarmador T	5	E-10534

Desarmador de golpe

NUEVO



Posee un refuerzo en la orilla del desarmador para brindar más resistencia a los golpes.

Punta negra con magnético que garantiza un ajuste perfecto

Diseñado para remover tornillos gastados y apretados, ya que posee un eje hexagonal que aumenta el apalancamiento y la torsión

Diseñado con acero de Vadamio cromado (CR-V) que previene la oxidación y la corrosión



Descripción	Empaque Piezas	No. Parte
Desarmador de golpe plano (5.5x75mm)	1	E-04933
Desarmador de golpe plano (6.5x150mm)	1	E-04949
Desarmador de golpe plano (8.0x200mm)	1	E-04955
Desarmador de golpe PH1 (#1x75)	1	B-66064
Desarmador de golpe PH2 (#2x100)	1	B-66070
Desarmador de golpe PH3 (#3x150)	1	B-66086
Desarmador de golpe PZ1 (#1x75)	1	B-66092
Desarmador de golpe PZ2 (#2x100)	1	B-66101
Desarmador de golpe PZ3 (#3x150)	1	B-66117

Atornillador manual tipo matraca



Incluye punta Phillips #2 (1Pz.)



Tamaño	Empaque Piezas	No. Parte
Estándar	1	D-58849

Desarmador de golpe

Al golpear la cabeza del desarmador con el martillo, gracias a su mecanismo interior, la punta del desarmador **GIRA**

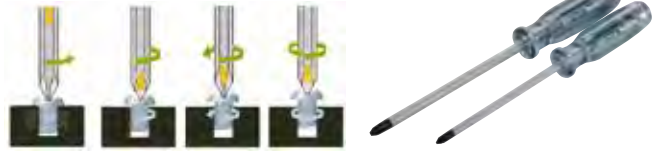

Descripción	Medida	Empaque piezas	No. Parte
Desarmador de impacto	125mm Ph2	1	B-42438
Desarmador de impacto	150mm Ph3	1	B-42444

Desarmador tipo matraca

Contiene 8 puntas

No. Parte **E-10942**



NUEVO

Empaque Piezas	Contenido	No. Parte
1	Desarmador tipo matraca Puntas de 1" PH1 (x1), PH2 (x1) PZ1 (x1), PZ2 (x2) T20 (x1), T30 (x1) SL 5.5 (x1)	E-10942

Juego de puntas y atornillador manual tipo matraca

47 accesorios

De alto desempeño, ideales para atornilladores a batería y herramientas eléctricas

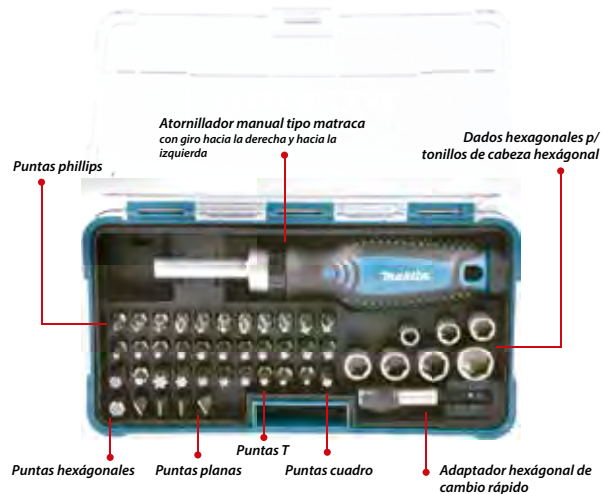

Atornillador manual tipo matraca con giro hacia la derecha y hacia la izquierda

Dados hexagonales / tornillos de cabeza hexagonal

Puntas phillips

Puntas hexagonales

Puntas planas

Puntas T

Puntas cuadro

Adaptador hexagonal de cambio rápido

Tamaño	Empaque Piezas	Contenido	No. Parte
Estándar	1 Juego	PH0x1, PHx2, PH2x6, PH3x2 T10x1, T15x1, T20x1, T25x2, T27x1, T30x1, T40x1 SL6-8x1, SL8-10x2, SL10-12x1 H1/8"x1, H3/16"x1, H1/4"x1 SQ1x3, SQ2x6, SQ3x3, 36mm Dados 3/16" 1/4", 9/32", 5/16", 11/32", 3/8", 7/16", Adaptador para dados.	B-50289

Accesorios ideales para herramienta inalámbrica



¿Cuál es el accesorio ideal para tu herramienta inalámbrica?

Proporciona mayor rendimiento a la herramienta.

Mayor velocidad, mayor cantidad de trabajo con una sola carga de batería y una agradable sensación de uso.

Aquí encontrará los accesorios que le brindan mayor rendimiento a sus herramientas inalámbricas Makita. Ubicará los accesorios por el ícono de herramienta inalámbrica y un destacado ícono de batería. Pruebe y vea la tecnología de vanguardia de MAKITA.

* Las características pueden variar según el artículo.



Disco de corte delgado

Espesor de 0.8mm para cortes rápidos

Disco más delgado

El espesor de 0.8mm proporciona:
Cortes más rápidos / Reducción de la resistencia del material al corte / menos polvo y rebaba



Cantidad de cortes por carga

20% Más



Discos de Corte y Desbaste 2 en 1

Es posible cortar y desbastar con un solo disco

Trabajo de corte especializado

Gracias a la malla "SA" y al grosor de 2.2mm permite cortar de forma rápida y desbastes ligeros



Cantidad de cortes por carga

15% Más



Disco de desbaste flexible

Baja vibración, sin almohadilla de respaldo

Estructura amortiguada

Con amortiguador que disminuye la vibración. Desbaste más rápido gracias al material flexible ya que puede desbastar materiales con mayor eficiencia

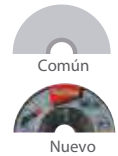

Cantidad de desbastes por carga

70% Más

Para azulejo

Disco de diamante delgado

Corte suave y ligero

Espesor más delgado

Con solo 1.4mm de espesor puedes obtener cortes suaves y ligeros

Orificios corrugados que aumentan la tensión del disco reduciendo la vibración durante el corte

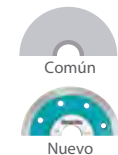
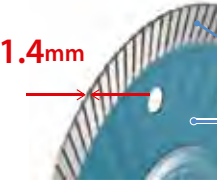

Cantidad de cortes por carga

60% Más

Para concreto / piedra

Especializado para trabajos de corte

Espesor de 1.6mm para cortes suaves y ligeros

Reduce la carga de la batería e incrementa la distancia de corte por cada carga de batería

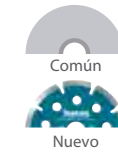
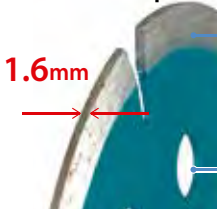

Cantidad de cortes por carga

50% Más



Discos abrasivos de corte

Especializados para metal



Hoja más delgada

Grosor de 2.5mm que permite cortes suaves y rápidos alargando la vida del disco



Cantidad de cortes por carga

30% más



Impact XPS

Línea premium de brocas y puntas, diseñada por expertos para soportar los golpes más fuertes de atornilladores de impacto, taladros y desarmadores.

Las brocas de inserción y brocas reforzadas Impact XPS están diseñadas con una horma superior, tecnología de torsión de zona y una composición de acero única para más duración de rendimiento de hasta 9 veces más que las brocas estándar.

La línea también incluye portabrocas de inserción, apretadores magnéticos, dados y adaptadores de dados para un rango completo de aplicaciones de apretado.

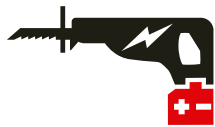

Segueta para sierra recíproca (dientes Japoneses)

Dientes Japoneses de 0.6mm de grosor para cortes finos de superficie

Forma del diente Japonés

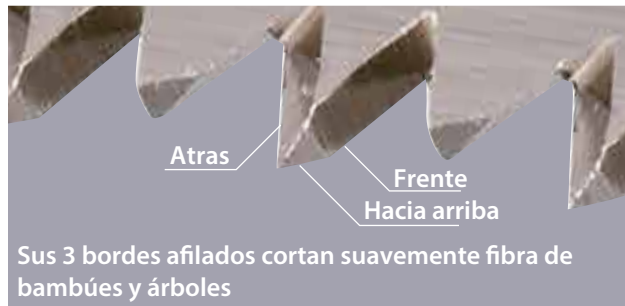

Para modelos: DR185, DJR183, DJR145, JR100D, JR103D, JR105D



Hilo Nylon en forma de trébol

Línea de 4 hojas

Diaméto	Color
1.65 mm	Azul
2.0 mm	Verde
2.4 mm	Anaranjado
2.7 mm	Rojo

Bajo nivel de ruido y ahorro de energía

Redondo

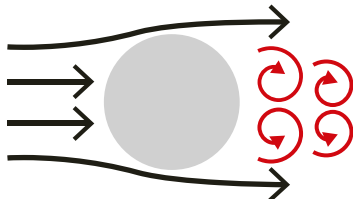

Forma de trébol

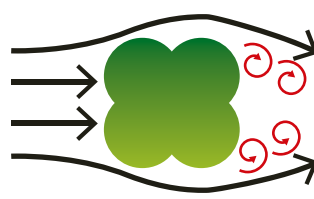

Esta forma hace un vórtice pequeño, realizando una función de bajo nivel de ruido y ahorro de energía gracias a que tiene una menor resistencia del aire.

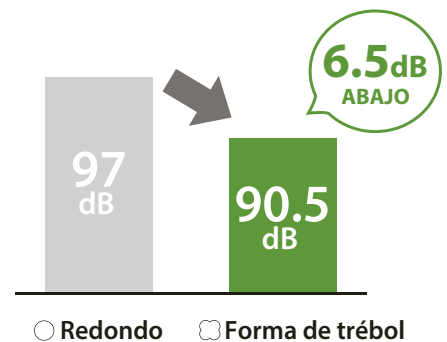



BROCAS METAL - MADERA



118° borde de cincel



135° Punta dividida



Alta velocidad



Alta velocidad, cobalto 5%



Punta de carburo de tungsteno



Para martillos SDS Plus



Utilice refrigerante



No perforar con impacto

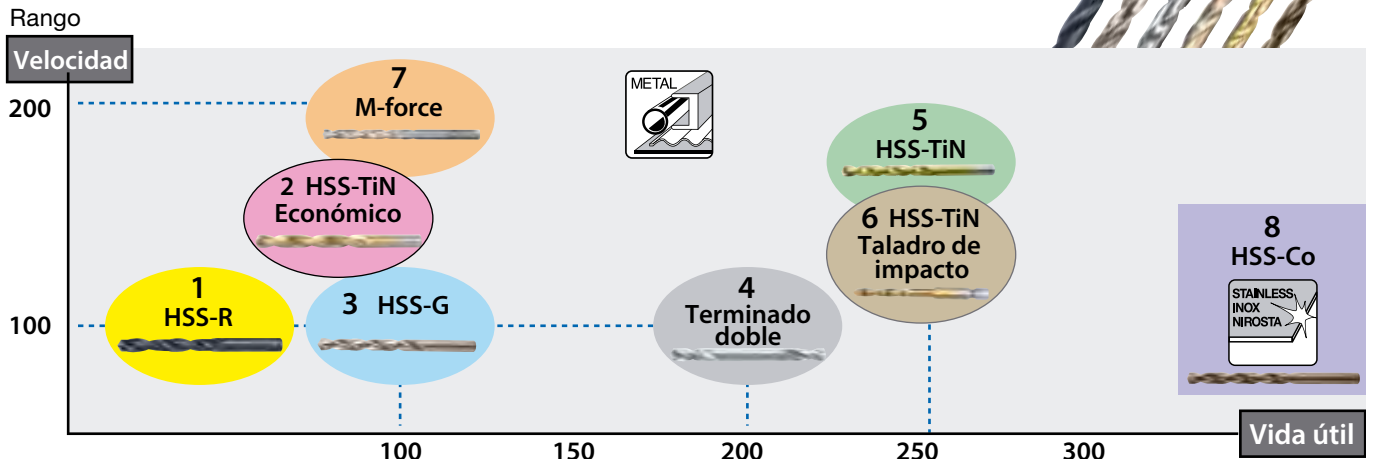
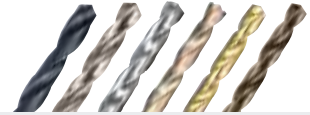

Descripción	1	2	3	4	5	6	7	8
Rango	★★	★★★★	★★★★	★★★★	★★★★★	★★★★★	★★★★★	Especializado
Descripción	broca de alta velocidad HSS-R	HSS-TiN económico	Broca de acero Alta velocidad HSS-G	Terminación doble	Broca de metal HSS-TiN	HSS-TiN Taladros de impacto	Punta de metal M-force	Broca de metal HSS-Co 5%
Hecha de				HSS				HSS-Co 5%
* Proceso de fabricación	Rollo forjado		Tierra					
** Punta geométrica	Chisel plano 118°	Punto 135°	Chisel plano 118°	Punto 135°			Forma M	Punto 135°
Superficie	Terminado Oxido negro Resistente al óxido	Cubierta de titanio Larga vida	Terminado brillante		Cubierta de titanio Larga vida		Terminado ámbar Resistente al óxido	
Caña	Recto (Cilíndrica)				Recto (Cilíndrica) 1/4"Hex	1/4"Hex	Recto (tres planos) Mejor agarre que el zanco cilíndrico	Recto (Cilíndrica)

*** Metal no ferroso (como cobre, níquel y zinc) AA : Recomendado A : Aceptable

Gráfica de material	1	2	3	4	5	6	7	8
Madera	A	A	A	A	A	A	A	
Plástico	AA	AA	AA	AA	AA	AA	AA	
Metal no ferroso ***		AA	AA	AA	AA	AA	AA	A
Chapa de acero	A	AA	AA	AA	AA	AA	AA	A
Hierro fundido	AA	AA	AA		AA	AA	AA	AA
Acero aleado		AA	AA		AA	AA	AA	AA
Acero inoxidable		A	A		A	A	A	AA



HSS SERIE DE BROCAS METAL

Hecho de **Acero de alta velocidad**



Acero de alta velocidad
(contiene **5%** de Cobalto)

Tiene mayor resistencia al calor y abrasión.
Adecuado para taladrar metales duros.

Proceso de fabricación

Rollo forjado



Fabricado con lámina fundida.
El precio es más económico.

Fresado



Broca fresada de larga duración.
Para desprender fácilmente el material.
La flauta y la punta de la broca permiten remover rápidamente el residuo de material.

Punta geométrica

Cinzel plano



Punto



División geométrica de la punta de 135 °,
que garantiza la precisión de la perforación.

Tipo M



La forma fue diseñada para centrarse en la perforación sin problemas y con rapidez.

Superficie

Terminado brillante



Terminado ámbar



Resistente a la oxidación

Recubrimiento de nitruro de titanio (TiN)



Dura más de 2.5 veces que el tipo de terminado sin revestimiento

Vástago

Recto (cilíndrico)



Recto (tres planos)



El mejor agarre de la empuñadura cilíndrica.

1/4"Hex



Permite un cambio fácil de punta

Brocas SDS PLUS Para madera y metal

Brocas SDS PLUS **únicas en su tipo** y sólo Makita las trajo al mercado

Ahora no solo con el rotomartillo SDS-Plus se podrá perforar concreto o ladrillo, también se podrá hacer perforaciones en madera y metal

- El nuevo diseño del zanco es para evitar que sea golpeado, aún así es recomendable usar solo en modo taladro.
- El zanco es más corto para que no se dañe, incluso si por error se selecciona la función de rotomartillo.



Entre el zanco y el percutor hay un espacio que evita que no golpee.



Con la broca para concreto el zanco y el percutor están pegados para romper el concreto.



Brocas SDS PLUS para metal

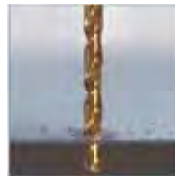

Medida: Pulgadas

Tamaño	Longitud total	Zanco Tipo	Empaque Piezas	No. Parte
1/8"	3 - 7/8"	SDS- Plus	1	B-59106
9/64"	4"	SDS- Plus	1	B-59112
5/32"	4 - 1/4"	SDS- Plus	1	B-59128
11/64"	4 - 3/8"	SDS- Plus	1	B-59134
3/16"	4 - 5/8"	SDS- Plus	1	B-59140
13/64"	4 - 3/4"	SDS- Plus	1	B-59156
7/32"	4 - 7/8"	SDS- Plus	1	B-59162
15/64"	5"	SDS- Plus	1	B-59178
1/4"	5 - 3/16"	SDS- Plus	1	B-59184

Brocas SDS PLUS para madera



Medida: Pulgadas

Tamaño	Longitud total	Zanco Tipo	Empaque Piezas	No. Parte
5/32"	4 - 1/8"	SDS- Plus	1	B-59190
3/16"	4 - 5/8"	SDS- Plus	1	B-59209
1/4"	5 - 1/8"	SDS- Plus	1	B-59215
5/16"	5 - 3/4"	SDS- Plus	1	B-59221
3/8"	6 - 3/8"	SDS- Plus	1	B-59237

Set de brocas SDS PLUS para madera y metal

5 Pzs.

Contenido	No. Parte
Metal 1-8", 3/16", 1/4" Madera 3/8", 1/4"	B-59243

Broca de alta velocidad-R

Broca de acero de alta velocidad



Medida: milímetros

Diámetro (mm)	Longitud Total	Longitud Trabajo	Empaque Piezas	No. Parte
1	34	12	10	D-38532
1.5	40	18	10	D-38548
2	49	24	10	D-38554
2.5	57	30	10	D-38560
3	61	33	10	D-38576
3.2	65	36	10	D-38582
3.5	70	39	10	D-38598
4	75	43	10	D-38607
4.2	75	43	10	D-38613
4.5	80	47	10	D-38629
4.8	86	52	10	D-38635
5	86	52	10	D-38641
5.5	93	57	10	D-38657
6	93	57	10	D-38663
6.5	101	63	10	D-38679
7	109	69	10	D-38685
7.5	109	69	10	D-38691
8	117	75	10	D-38700
8.5	117	75	10	D-38716
9	125	81	10	D-38722
9.5	125	81	10	D-38738
10	133	87	10	D-38744
11	142	94	1	D-38504
12	151	101	1	D-38510
13	151	101	1	D-38526



Broca de acero de alta velocidad-G

Broca de acero de alta velocidad

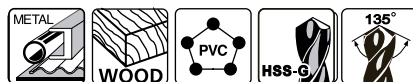

Medida: Pulgadas

** Sin exhibidor

Diámetro	Longitud Total	Longitud Trabajo	Empaque Piezas	No. Parte
1/16"	1-7/8"	7/8"	10	D-21945
5/64"	2"	1"	10	D-21951
3/32"	2-1/4"	1-1/4"	10	D-21967
7/64"	2-5/8"	1-1/2"	10	D-21973
1/8"	2-3/4"	1-5/8"	10	D-21989
9/64"	2-7/8"	1-3/4"	10	D-21995
5/32"	3-1/8"	2"	10	D-22006
11/64"	3-1/4"	2-1/8"	10	D-22012
3/16"	3-1/2"	2-5/16"	10	D-22028
13/64"	3-5/8"	2-7/16"	10	D-22034
7/32"	3-3/4"	2-1/2"	10	D-22040
15/64"	3-7/8"	2-5/8"	10	D-22056
1/4"	4"	2-3/4"	10	D-22062
17/64"	4-1/8"	2-7/8"	10	D-22078
9/32"	4-1/4"	2-15/16"	10	D-22084
19/64"	4-3/8"	3-1/16"	10	D-22096
5/16"	4-1/2"	3-3/16"	10	D-22109
3/8"	5"	3-5/8"	10	D-37219
1/16"	1-7/8"	7/8"	2	D-22230
5/64"	2"	1"	2	D-22246
3/32"	2-1/4"	1-1/4"	2	D-22252
7/64"	2-5/8"	1-1/2"	2	D-22268
1/8"	2-3/4"	1-5/8"	2	D-22274
9/64"	2-7/8"	1-3/4"	2	D-22280
5/32"	3-1/8"	2"	1	D-22296
11/64"	3-1/4"	2-1/8"	1	D-22305
3/16"	3-1/2"	2-5/16"	1	D-22311
13/64"	3-5/8"	2-7/16"	1	D-22327
7/32"	3-3/4"	2-1/2"	1	D-22333
15/64"	3-7/8"	2-5/8"	1	D-22349
1/4"	4"	2-3/4"	1	D-22355
17/64"	4-1/8"	2-7/8"	1	D-22361
9/32"	4-1/4"	2-15/16"	1	D-22377
19/64"	4-3/8"	3-1/16"	1	D-22383
5/16"	4-1/2"	3-3/16"	1	D-22399
21/64"	4-5/8"	3-5/16"	1	D-22408
11/32"	4-3/4"	3-7/16"	1	D-22414
23/64"	4-7/8"	3-1/2"	1	D-22420

Broca de acero de alta velocidad-G

Broca de acero de alta velocidad

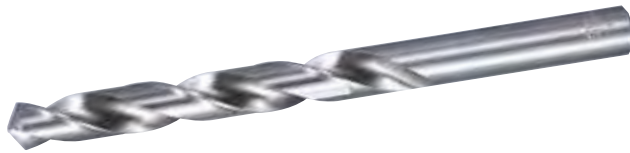
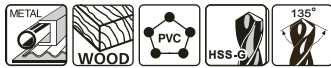

Medida: Pulgadas

** Sin exhibidor

Diámetro	Longitud Total	Longitud Trabajo	Empaque Piezas	No. Parte
3/8"	5"	3-5/8"	1	D-22436
25/64"	5-1/8"	3-3/4"	1	D-22442
13/32"	5-1/4"	3-7/8"	1	D-22458
27/64"	5-3/8"	3-15/16"	1	D-22464
7/16"	5-1/2"	4-1/16"	1	D-22470
29/64"	5-5/8"	4-3/16"	1	D-22486
15/32"	5-3/4"	4-5/16"	1	D-22492
31/64"	5-7/8"	4-3/8"	1	D-22501
1/2"	6"	4-1/2"	1	D-22517

Broca de acero de alta velocidad-G (HSS-TiN)

Titanio

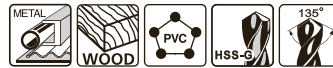

Medida: Pulgadas

Diámetro	Longitud Trabajo	Longitud Total	Empaque Piezas	No. Parte
9/32"	4-1/4"	2-15/16"	1	D-60349
19/64"	4-3/8"	3-1/16"	1	D-60355
21/64"	4-5/8"	3-5/16"	1	D-60377
11/32"	4-3/4"	3-7/16"	1	D-60383
25/64"	5-1/8"	3-3/4"	1	D-60414
13/32"	5-1/4"	3-7/8"	1	D-60420
27/64"	5-3/8"	3-15/16"	1	D-60436
7/16"	5-1/2"	4-1/16"	1	D-60442
29/64"	5-5/8"	4-3/16"	1	D-60458
15/32"	5-3/4"	4-5/16"	1	D-60464
31/64"	5-7/8"	4-3/8"	1	D-60470

Broca de acero de alta velocidad-G (HSS-TiN)

Titanio



Medida: Pulgadas

Diámetro	Longitud Trabajo	Longitud Total	Empaque Piezas	No. Parte
5/64"	2"	1"	2	D-60218
7/64"	2-5/8"	1-1/2"	2	D-60230
9/64"	2-7/8"	1-3/4"	2	D-60252
5/32"	3-1/8"	2"	1	D-60268
13/64"	3-5/8"	2-7/16"	1	D-60296
7/32"	3-3/4"	2-1/2"	1	D-60305
15/64"	3-7/8"	2-5/8"	1	D-60311
17/64"	4-1/8"	2-7/8"	1	D-60333

Broca de acero HSS-TiN

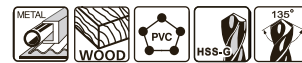

Punta a 135° que evita se deslice cuando se perfora



Espiral Half-ground

Recubrimiento de titanio



Medida: Pulgadas

Diámetro	Longitud	Longitud Trabajo	Zanco Tipo	Empaque Piezas	No. Parte
1/16"	1-7/8"	7/8"	cilindrico	2	D-64509
5/64"	2"	1"	cilindrico	2	D-64515
3/32"	2-1/4"	2-1/4"	cilindrico	2	D-64521
7/64"	2-5/8"	1-1/2"	cilindrico	2	D-64537
1/8"	2-3/4"	1-5/8"	cilindrico	2	D-64543
9/64"	2-7/8"	1-3/4"	cilindrico	2	D-64559
5/32"	3-1/8"	2"	cilindrico	1	D-64565
11/64"	3-1/4"	2-1/8"	cilindrico	1	D-64571
3/16"	3-1/2"	2-5/16"	cilindrico	1	D-64587
13/64"	3-5/8"	2-7/16"	cilindrico	1	D-64593
7/32"	3-3/4"	2-1/2"	cilindrico	1	D-64602
15/64"	3-7/8"	2-5/8"	cilindrico	1	D-64618
1/4"	4"	2-3/4"	cilindrico	1	D-64624

Broca de acero alta velocidad TiN

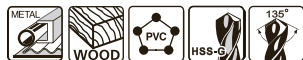

Punta a 135° que evita se deslice cuando se perfora



Espiral Half-ground Recubrimiento de titanio



Medida: Pulgadas

Diámetro	Longitud	Longitud Trabajo	Zanco Tipo	Empaque Piezas	No. Parte
17/64"	4-1/8"	2-7/8"	cilíndrico	1	D-64630
9/32"	4-1/4"	2-15/16"	cilíndrico	1	D-64646
19/64"	4-3/8"	3-1/16"	cilíndrico	1	D-64652
5/16"	4-1/2"	3-3/16"	cilíndrico	1	D-64668
21/64"	4-5/8"	3-5/16"	cilíndrico	1	D-64674
11/32"	4-3/4"	3-7/16"	cilíndrico	1	D-64680
23/64"	4-7/8"	3-1/2"	cilíndrico	1	D-64696
3/8"	5"	3-5/8"	cilíndrico	1	D-64705
25/64"	5-1/8"	3-3/4"	cilíndrico	1	D-64711
13/32"	5-1/4"	3-7/8"	cilíndrico	1	D-64727
27/64"	5-3/8"	3-15/16"	cilíndrico	1	D-64733
7/16"	5-1/2"	4-1/16"	cilíndrico	1	D-64749
29/64"	5-5/8"	4-3/16"	cilíndrico	1	D-64755
15/32"	5-3/4"	4-5/16"	cilíndrico	1	D-64761
31/64"	5-7/8"	4-3/8"	cilíndrico	1	D-64777
1/2"	6"	4-1/2"	cilíndrico	1	D-64783

Broca de acero alta velocidad TiN

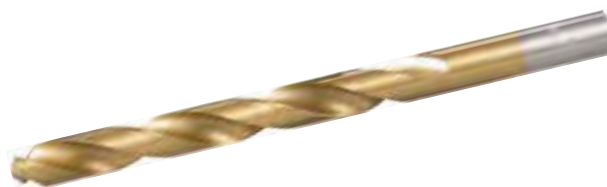

Medida: Pulgadas

Diámetro	Longitud	Longitud Trabajo	Zanco Tipo	Empaque Piezas	No. Parte
1/16"	1-7/8"	7/8"	cilíndrico	10	D-64799
5/64"	2"	1"	cilíndrico	10	D-64808
3/32"	2-1/4"	1-1/4"	cilíndrico	10	D-64814
7/64"	2-5/8"	1-1/2"	cilíndrico	10	D-64820
1/8"	2-3/4"	1-5/8"	cilíndrico	10	D-64836
9/64"	2-7/8"	1-3/4"	cilíndrico	10	D-64842
5/32"	3-1/8"	2"	cilíndrico	10	D-64858
11/64"	3-1/4"	2-1/8"	cilíndrico	10	D-64864
3/16"	3-1/2"	2-5/16"	cilíndrico	10	D-64870
13/64"	3-5/8"	2-7/16"	cilíndrico	10	D-64886
7/32"	3-3/4"	2-1/2"	cilíndrico	10	D-64892
1/4"	4"	2-3/4"	cilíndrico	10	D-64901
5/16"	4-1/2"	3-3/16"	cilíndrico	10	D-64917

Broca de acero alta velocidad TiN

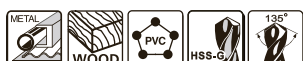

Punta a 135° que evita se deslice cuando se perfora



Medida: Pulgadas

Diámetro	Longitud	Longitud Trabajo	Zanco Tipo	Empaque Piezas	No. Parte
3/8"	5"	3-5/8"	cilíndrico	5	D-64923
7/16"	5-1/2"	4-1/16"	cilíndrico	5	D-64939
1/2"	6"	4-1/2"	cilíndrico	5	D-64945

Broca de acero de alta velocidad

Terminado doble



Medida: mm

Diámetro (mm)	Longitud Total (mm)	Longitud Trabajo (mm)	Empaque Piezas	No. Parte
3.1	49	11	10	B-26674
3.2	49	11	10	B-26680
4.1	55	14	10	B-26733
4.2	55	14	10	B-26749
4.8	62	17	10	B-26777
4.9	62	17	10	B-26783
5.5	66	19	10	B-26820
6	66	19	10	B-26836
8	79	25	10	B-26842
10	89	25	10	B-26858

Broca de acero de alta velocidad

Terminado doble

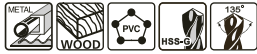

Medida: Pulgadas

Diámetro	Longitud Total	Longitud Trabajo	Empaque Piezas	No. Parte
7/64"	1-7/8"	5/8"	10	B-29907
1/8"	2"	5/8"	10	B-29913
9/64"	2"	5/8"	10	B-29929
5/32"	2-1/16"	5/8"	10	B-29935
3/16"	2-3/16"	5/8"	10	B-29941
7/32"	2-3/8"	11/16"	10	B-29957
1/4"	2-1/2"	7/8"	10	B-29963
#30	2"	5/8"	10	B-29979
#20	2-1/8"	5/8"	10	B-29985
#11	2-1/4"	11/16"	10	B-29991

Juego de brocas de acero alta velocidad-G Zanco Hex

Empaque con 5 Piezas

No. Parte D-20769



Medida: mm

Diámetro	Longitud Total	Longitud Trabajo	Empaque Piezas	No. Parte
* Metal 5,6,8mm * Madera 5,6mm	3-7/8", 4", 4-1/2"		5	D-20769

Juego de brocas de acero alta velocidad-G Zanco cilíndrico

Empaque con 5 Piezas

No. Parte D-30112

Medida: Pulgadas

Diámetro	Longitud Total	Longitud Trabajo	No. Parte
Metal 3/16, 1/4", 5/16"	3-1/2", 4", 4-1/2"	2-1/16", 2-3/4", 3-3/16"	D-30112
Madera 1/4", 5/16"	4", 4-1/2"	2-3/4", 3-3/16"	



Juego de brocas HSS-G para metal

Empaque con 6 Piezas

No. Parte D-57196



Medidas: mm

Diámetro		Longitud total		No. Parte
2.0mm	5.0mm	24mm	52mm	D-57196
3.0mm	6.0mm	33mm	57mm	
4.0mm	8.0mm	43mm	75mm	



Juego de brocas HSS-G para metal

Empaque con 10 Piezas

No. Parte D-57205



Medidas: mm

Diámetro		Longitud total	
1.0mm	12mm	6.0mm	57mm
2.0mm	24mm	7.0mm	69mm
3.0mm	33mm	8.0mm	75mm
4.0mm	43mm	9.0mm	81mm
5.0mm	52mm	10mm	87mm

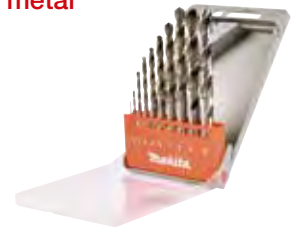

Juego de brocas de alta velocidad TiN con inserción Hex. 1/4"

5 Pzs.



No. Parte D-35318

Contenido	Zanco Tipo	No. Parte
1/8", 5/32", 3/16", 1/4", 5/16"	Hexagonal 1/4"	D-35318

Juego de brocas de alta velocidad TiN

18 Pzs.

NUEVO



No. Parte D-70471

Diámetro					No. parte
1/16" (2pzs)	5/64"	3/32" (2pzs)	1/8" (2pzs)	9/64"	D-70471
5/32"	11/64"	3/16"	13/64"	7/32"	
1/4"	5/16"	3/8"	1/2"		

Juego de brocas de alta velocidad TiN con inserción Hex. 1/4"

19 Pzs.

NUEVO



No. Parte B-67795

Diámetro							No. parte
1.5mm	2.0mm	2.5mm	3.0mm	3.2mm	3.5mm	4.0mm	B-67795
4.5mm	5.0mm	5.5mm	6.0mm	6.5mm	7.0mm	8.0mm	
10.0mm							

Juego de brocas de alta velocidad TiN para metal

21 Pzs.

NUEVO

No. Parte **D-72447**



Diámetro					No. parte
1/16"	5/64"	3/32"	7/64"	1/8"	
9/64"	5/32"	11/64"	3/16"	13/64"	
7/32"	15/64"	1/4"	17/64"	9/32"	
19/64"	5/16"	21/64"	11/32"	23/64"	
3/8"					

Broca de alta velocidad TiN con inserción Hex. 1/4"

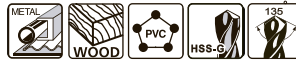

Medida: Pulgadas

Diámetro	Longitud	Longitud Trabajo	Zanco Tipo	Empaque Piezas	No. Parte
7/64"	3-15/32"	1-1/2"	MZ	1	D-23874
1/8"	3-15/32"	1-5/8"	MZ	1	D-23880
9/64"	3-1/2"	1-3/4"	MZ	1	D-23896
5/32"	3-13/16"	2"	MZ	1	D-23905
3/16"	4-7/32"	2-5/16"	MZ	1	D-23911
1/4"	4-3/4"	2-3/4"	MZ	1	D-23927
5/16"	4-1/2"	3-3/16"	MZ	1	D-23933
3/8"	5"	3-5/8"	MZ	1	D-23949

Broca para remaches con zanco Hex 1/4"

NUEVO

No. Parte **B-56437**

Ideal para usuarios que necesitan taladrar agujeros para remaches



Medida	Zanco Tipo	No. parte
3.3x50mm	1/4" Hexagonal	B-56437

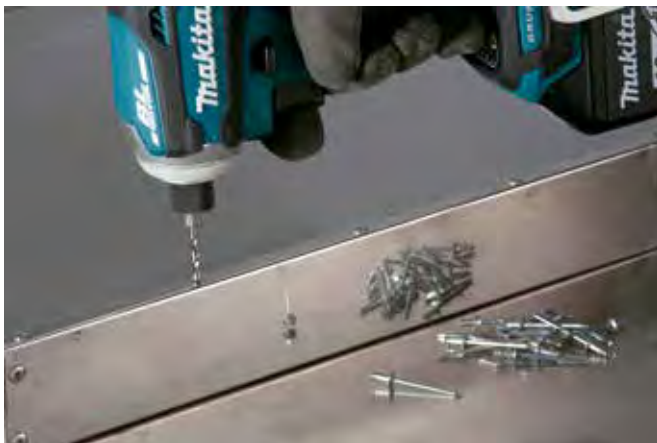

Juego combinado de brocas (Concreto, madera y metal)

Paquete de brocas con inserción Hex. 1/4"

No. Parte **D-23765**



Diámetro	No. Parte
Concreto: 3/16", 1/4" madera - metal: 1/8", 3/16", 1/4"	D-23765

Juego de brocas HSS-Co para metal

Empaque con 6 Piezas

No. Parte **D-57168**



Medidas: mm

Diámetro	Longitud total	No. Parte
2.0mm	24mm	D-57168
3.0mm	33mm	
4.0mm	43mm	
5.0mm	52mm	
6.0mm	57mm	
8.0mm	75mm	



Brocas HSS-Co (cobalto 5%)

Brocas de acero de alta velocidad



Medida: Pulgadas

Diámetro	Longitud Total	Longitud Trabajo	Empaque Piezas	No. Parte
1/16"	1-7/8"	7/8"	5	D-22816
5/64"	2"	1"	5	D-22822
3/32"	2-1/4"	1-1/4"	5	D-22838
7/64"	2-5/8"	1-1/2"	5	D-22844
1/8"	2-3/4"	1-5/8"	5	D-22850
9/64"	2-7/8"	1-3/4"	5	D-22866
5/32"	3-1/8"	2"	5	D-22872
11/64"	3-1/4"	2-1/8"	5	D-22888
3/16"	3-1/2"	2-5/16"	5	D-22894
13/64"	3-5/8"	2-7/16"	5	D-22903
7/32"	3-3/4"	2-1/2"	5	D-22919
15/64"	3-7/8"	2-5/8"	5	D-22925
1/4"	4"	2-3/4"	5	D-22931
17/64"	4-1/8"	2-7/8"	5	D-22947
9/32"	4-1/4"	2-15/16"	5	D-22953
19/64"	4-3/8"	3-1/16"	5	D-22969
5/16"	4-1/2"	3-3/16"	5	D-22975
21/64"	4-5/8"	3-5/16"	5	D-22981
11/32"	4-3/4"	3-7/16"	5	D-22997
23/64"	4-7/8"	3-1/2"	5	D-23008
3/8"	5"	3-5/8"	5	D-23014
25/64"	5-1/8"	3-3/4"	5	D-23020
13/32"	5-1/4"	3-7/8"	5	D-23036
27/64"	5-3/8"	3-15/16"	5	D-23042
7/16"	5-1/2"	4-1/16"	5	D-23058
29/64"	5-5/8"	4-3/16"	5	D-23064
15/32"	5-3/4"	4-5/16"	5	D-23070
31/64"	5-7/8"	4-3/8"	5	D-23086
1/2"	6"	4-1/2"	5	D-23092
1/16"	1-7/8"	7/8"	2	D-22523
5/64"	2"	1"	2	D-22539
3/32"	2-1/4"	1-1/4"	2	D-22545
7/64"	2-5/8"	1-1/2"	2	D-22551
1/8"	2-3/4"	1-5/8"	2	D-22567
5/32"	3-1/8"	2"	1	D-22589
11/64"	3-1/4"	2-1/8"	1	D-22595
3/16"	3-1/2"	2-5/16"	1	D-22604
13/64"	3-5/8"	2-7/16"	1	D-22610
7/32"	3-3/4"	2-1/2"	1	D-22626
15/64"	3-7/8"	2-5/8"	1	D-22632

Brocas HSS-Co (cobalto 5%)

Brocas de acero de alta velocidad



Medida: Pulgadas

Diámetro	Longitud Total	Longitud Trabajo	Empaque Piezas	No. Parte
1/4"	4"	2-3/4"	1	D-22648
17/64"	4-1/8"	2-7/8"	1	D-22654
9/32"	4-1/4"	2-15/16"	1	D-22660
19/64"	4-3/8"	3-1/16"	1	D-22676
5/16"	4-1/2"	3-3/16"	1	D-22682
21/64"	4-5/8"	3-5/16"	1	D-22698
11/32"	4-3/4"	3-7/16"	1	D-22707
23/64"	4-7/8"	3-1/2"	1	D-22713
3/8"	5"	3-5/8"	1	D-22729
25/64"	5-1/8"	3-3/4"	1	D-22735
13/32"	5-1/4"	3-7/8"	1	D-22741
27/64"	5-3/8"	3-15/16"	1	D-22757
7/16"	5-1/2"	4-1/16"	1	D-22763
29/64"	5-5/8"	4-3/16"	1	D-22779
15/32"	5-3/4"	4-5/16"	1	D-22785
31/64"	5-7/8"	4-3/8"	1	D-22791
1/2"	6"	4-1/2"	1	D-22800

Juego de brocas HSS-Co para metal

Empaque con 10 Piezas

No. Parte **D-57174**



Diámetro	Longitud total	No. Parte
1.0mm	12mm	D-57174
2.0mm	24mm	
3.0mm	33mm	
4.0mm	43mm	
5.0mm	52mm	
6.0mm	57mm	
7.0mm	69mm	
8.0mm	75mm	
9.0mm	81mm	
10mm	87mm	

El equipo estándar (accesorios), las especificaciones y las fotografías pueden variar. Los accesorios pueden no estar incluidos desde origen con las herramientas, aunque se indiquen en este catálogo.

Juego de brocas HSS-Co para metal

Empaque con 13 Piezas

No. Parte **D-57180**



Medidas: mm

Diámetro	Longitud total	Diámetro	Longitud total
1.5mm	18mm	4.5mm	47mm
2.0mm	24mm	4.8mm	52mm
2.5mm	30mm	5.0mm	52mm
3.0mm	33mm	5.5mm	57mm
3.2mm	36mm	6.0mm	57mm
3.5mm	39mm	6.5mm	63mm
4.0mm	43mm		

Juego de brocas estándar HSS-Tin

Empaque con 13pzs

No. Parte **D-72908**



NUEVO



Medidas: pulgadas

Diámetro				
1/16" (2pzs)	5/64"	3/32" (2pzs)	7/64"	1/8" (2pzs)
9/64"	5/32"	3/16"	7/32"	1/4"

Juego de brocas HSS-Co para acero inoxidable

Empaque con 25 Piezas

No. Parte **D-50479**



Medidas: mm

Diámetro						
1.0mm	3.0mm	5.0mm	7.0mm	9.0mm	11.0mm	13.0mm
1.5mm	3.5mm	5.5mm	7.5mm	9.5mm	11.5mm	
2.0mm	4.0mm	6.0mm	8.0mm	10.0mm	12.0mm	
2.5mm	4.5mm	6.5mm	8.5mm	10.5mm	12.5mm	

Juego de brocas estándar

Combinado (9 pzs)

No. Parte **D-71984**

NUEVO



Medidas: Pulgadas

Diámetro	
Metal 3/16", 1/4", 5/16"	Concreto 3/16", 1/4", 5/16"
Madera 3/16", 1/4", 5/16"	

Juego de brocas estándar

Combinado (9 pzs)

No. Parte **D-16449**



Medidas: Pulgadas

Diámetro
Metal 3/16", 1/4", 5/16"
Concreto 3/16", 1/4", 5/16"
Madera 3/16", 1/4", 5/16"

Juego de brocas estándar

Combinado (18 pzs)

No. Parte **D-59178**



Diámetro
1/8", 5/32", 3/16", 1/4", 5/16", 3/8"
Metal, concreto, madera

Aceite micro oleo en aerosol

No. Parte **0042010**

Aplicación
Lubricación entre broca y metal para evitar sobrecalentamientos



Brocas escalonadas

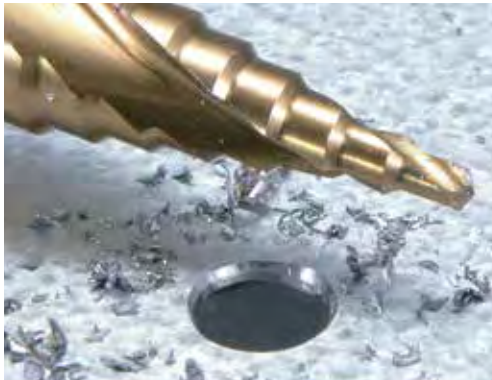

Rango

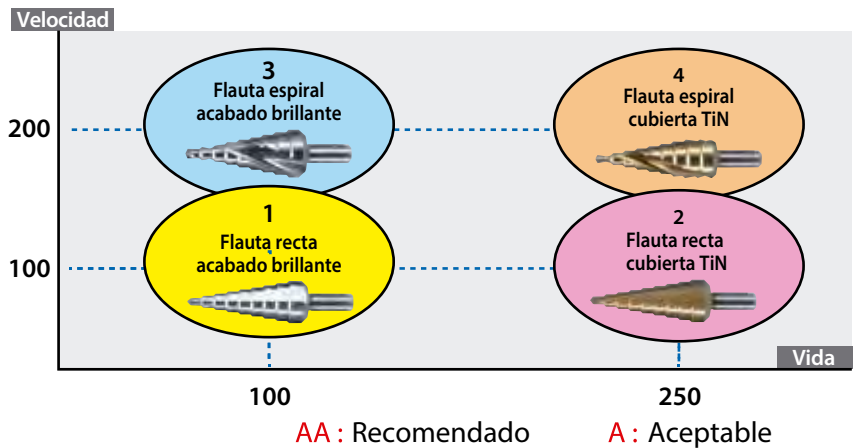

Gráfica de material

Descripción	Material								
	A Flauta	B Superficie	C Vástago	Plástico	Metal no ferroso (como el cobre, níquel y zinc)	Chapa de acero	Acero aleado	Hierro fundido	
1	Recta	Terminado brillante	Recto (Tres planos) El mejor agarre de la empuñadura cilíndrica	AA	AA	AA	A	A	
2	Recta	Recubrimiento de titanio Dura más de 2.5 veces que el tipo de acabado brillante		AA	AA	AA	A	A	
3	Espiral Dos veces más rápida que la flauta recta	Terminado brillante	1/4" Hex (forma E) Puede ser utilizado con porta punta de 1/4" Permite un cambio fácil de punta	AA	AA	AA	A	A	
4	Espiral Dos veces más rápida que la flauta recta	Recubrimiento de titanio Dura más de 2.5 veces que el tipo de acabado brillante		AA	AA	AA	A	A	

Metal no ferroso (como el cobre, níquel y zinc)

Broca cónica



Diámetro (mm)	Longitud total (mm)	Longitud trabajo (mm)	Zanco tipo	Empaque Piezas	No. Parte
3-14	58	38	Recto (tres planos)	1	D-40048
4-20	71	51	Recto (tres planos)	1	D-40054

Brocas escalonadas rectas HSS-milimétricas



Diámetro (mm)	Longitud total (mm)	Longitud trabajo (mm)	Zanco tipo	Empaque Piezas	No. Parte
4-12	65	45	1/4" Hex. (MZ)	1	D-40082
4-20	75	53	1/4" Hex. (MZ)	1	D-40098
4-32	102	80	Recto (tres planos)	1	D-40107

Broca cónica

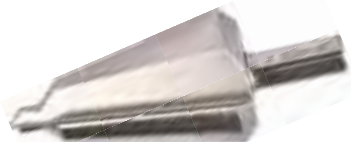

Diámetro (mm)	Longitud total (mm)	Longitud trabajo (mm)	Zanco tipo	Empaque Piezas	No. Parte
16-30.5	76	51	Recto (tres planos)	1	D-40060
24-40	89	64	Recto (tres planos)	1	D-40076

Broca escalonada recta HSS-Ti-milimétricas Cubierta de titanio



Diámetro (mm)	Longitud total (mm)	Longitud trabajo (mm)	Zanco tipo	Empaque Piezas	No. Parte
4-12	65	45	1/4" Hex. (MZ)	1	D-40113
4-20	75	53	1/4" Hex. (MZ)	1	D-40129
4-32	102	80	Recto (tres planos)	1	D-40135

El equipo estándar (accesorios), las especificaciones y las fotografías pueden variar. Los accesorios pueden no estar incluidos desde origen con las herramientas, aunque se indiquen en este catálogo.

Brocas escalonadas espirales HSS-milimétricas



Diseñadas para perforar en chapa metálica
Hecha de acero de alta velocidad HSS
 Con revestimiento de Estaño



Adecuado para la expansión
 de los agujeros existentes



Diámetro (mm)	Longitud total (mm)	Longitud trabajo (mm)	Zanco tipo	Empaque Piezas	No. Parte
4-12	65	45	1/4" Hex. (MZ)	1	D-40141
4-20	75	53	1/4" Hex. (MZ)	1	D-40157
4-32	102	80	Recto (tres planos)	1	D-40163

Brocas escalonadas rectas HSS-Ti Titanio

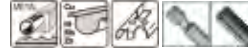

Medida: Pulgadas

Diámetro	Longitud total	Longitud trabajo	Zanco tipo	Empaque Piezas	No. Parte
1/8"-1/2"	3-9/32"	2-1/2"	1/4" Hex. (MZ)	1	B-31011
3/16"-1/2"	3-9/32"	2-1/2"	1/4" Hex. (MZ)	1	B-31027
3/16"-7/8"	3"	2"	Recto (tres planos)	1	B-31033
1/4"-3/4"	2-5/8"	1-3/4"	Recto (tres planos)	1	B-31049
1/4"-1-3/8"	3"	2-1/8"	Recto (tres planos)	1	B-31055

Brocas escalonadas rectas Titanio



Diámetro	Longitud total	Longitud trabajo	Zanco tipo	Empaque Piezas	No. Parte
7/8"	2-3/16"	1-3/16"	Recto (tres planos)	1	B-31083

Brocas escalonadas espirales HSS-Ti-milimétricas Titanio



Diseñadas para perforar en chapa metálica
Hecha de acero de alta velocidad HSS
 Con cobertura de Nitruro de titanio TiN



Adecuado para la expansión de los agujeros existentes



Diámetro (mm)	Longitud total (mm)	Longitud trabajo (mm)	Zanco tipo	Empaque Piezas	No. Parte
4-12	65	45	1/4" Hex. (MZ)	1	D-40179
4-20	75	53	1/4" Hex. (MZ)	1	D-40185
4-32	102	80	Recto (tres planos)	1	D-40191

Brocas escalonadas rectas HSS-Ti estándar Titanio

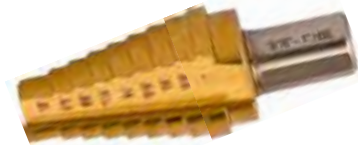

Medida: Pulgadas

Diámetro	Longitud total	Longitud trabajo	Zanco tipo	Empaque Piezas	No. Parte
9/16"-1"	2-1/2"	1-1/2"	Recto (tres planos)	1	B-31061
13/16"-1-3/8"	3"	2"	Recto (tres planos)	1	B-31077

Brocas escalonadas espirales rectas HSS-Ti Titanio



Medida: Pulgadas

Diámetro	Longitud total	Longitud trabajo	Zanco tipo	Empaque Piezas	No. Parte
1/8"-1/2"	3-9/32"	2-1/2"	1/4" Hex. (MZ)	1	B-31099
3/16"-1/2"	3-9/32"	2-1/2"	1/4" Hex. (MZ)	1	B-31108
3/16"-7/8"	3"	2"	Recto (tres planos)	1	B-31114
1/4"-3/4"	2-5/8"	1-3/4"	Recto (tres planos)	1	B-31120
1/4"-1-3/8"	3"	2-1/8"	Recto (tres planos)	1	B-31136



TIPOS DE AVELLANADORES

Imágenes solo ilustrativas

Gráfica de material

AA: Recomendado

A: Aceptable

Descripción	A Hecho de	B Tipo	C Vastago	Material							
				Madera	Plástico	*Metal no ferroso	Hierro fundido	Acero aleado	Acero inoxidable		
7 cortes a la orilla 	Acero aleado	Hundimiento superficial Adecuado para avellanado plano	1/4"Hex	AA	AA	AA	AA				
3 cortes a la orilla <i>* no disponible para venta en México</i>		Profundidad Apto para profundidad de avellanado	1/4"Hex (forma C)	AA	AA	AA	AA	AA			
5 cortes a la orilla 	Acero de alta velocidad	Hundimiento superficial Adecuado para avellanado plano	Zanco recto	AA	AA	AA	AA	AA			
3 cortes a la orilla <i>* no disponible para venta en México</i>		Profundidad Apto para profundidad de avellanado	Zanco recto	AA	AA	AA	AA	AA			
Inclinación de la perforación Tiene mayor resistencia al calor y abrasión. Adecuado para taladrar metales duros. <i>* no disponible para venta en México</i>	Acero de alta velocidad (5% cobalto)	Hundimiento superficial Apto para profundidad de avellanado, especialmente en hojas delgadas de metal.	Zanco recto			AA	AA	AA	AA		A

* Metal no ferroso (como el cobre, níquel y zinc)

Avellanadores HSS zanco recto



Medida: Pulgadas

Diámetro	Longitud total	Empaque Piezas	Aplicación	No. Parte
1/2"	1-5/8"	1	-	B-30003
5/8"	1-3/4"	1	-	B-30019
3/4"	1-3/4"	1	-	B-30025

Aceite refrigerante para corte

Para cortadores anulares

Especialmente formulado para mejorar la velocidad de corte y prolongar la vida útil de la herramienta.



Avellanador cubierta de titanio con 82°

Punta cortante



Medida: Pulgadas

Diámetro	Longitud total	Empaque Piezas	Aplicación	No. Parte
1/2"	1-5/8"	1	-	B-30031
5/8"	1-3/4"	1	-	B-30047
3/4"	1-3/4"	1	-	B-30053

Avellanador cubierta de Titanio con 82°

Punta cortante



Medida: Pulgadas

Diámetro	Longitud total	Empaque Piezas	Aplicación	Zanco	No. Parte
1/2"	1-5/8"	1	-	1/4"	B-30097
5/8"	1-3/4"	1	-	1/4"	B-30106
3/4"	1-3/4"	1	-	1/4"	B-30112

Avellanador cinco filos con 82°

Punta cortante



Medida: Pulgadas

Diámetro	Longitud total	Empaque Piezas	Aplicación	Zanco	No. Parte
1/2"	2"	1	-	1/4" Hex	B-30069
5/8"	2"	1	-	1/4" Hex	B-30075
3/4"	2"	1	-	1/4" Hex	B-30081

Pilotos y adaptadores



Descripción	Unidad	No. Parte
Piloto centrado 1"	1	Pilot S
Piloto centrado 2"	1	Pilot L
Piloto adaptador corto	1	Pilot S12S
Piloto adaptador largo	1	Pilot L12L
Broquero con adaptador	1	Chuc05
Piloto centrador (P/carburo 1-3/8") 6mm	1	Pilot U1A
Piloto centrador (P/carburo 1-3/8") 7mm	1	Pilot U1B
Piloto centrador (P/carburo 2-3/16") 6mm	1	Pilot U2A
Piloto centrador (P/carburo 2-3/16") 7mm	1	Pilot U2B
Piloto centrador corto alcance 7/16" (P/cobalto)	1	Pilot S12
Piloto centrador largo alcance 7/16" (P/cobalto)	1	Pilot L12

Descripción	Piezas por empaque	No. Parte
Aceite refrigerante para corte Utilizar con cortadores anulares	2	OIL02
Concentrado (50ml) + Recipiente p/ mezclar (500ml)		



Cortadores anulares acero alta velocidad
Taladro magnético

Cortadores anulares HSS 1"
Para taladros magnéticos



Diámetro	Longitud	Unidad	No. Parte
7/16"	1"	Pieza	US 7/16"x1"
1/2"	1"	Pieza	US 1/2"x1"
9/16"	1"	Pieza	US 9/16"x1"
5/8"	1"	Pieza	US 5/8"x1"
11/16"	1"	Pieza	US 11/16"x1"
3/4"	1"	Pieza	US 3/4"x1"
13/16"	1"	Pieza	US 13/16"x1"
7/8"	1"	Pieza	US 7/8"x1"
15/16"	1"	Pieza	US 15/16"x1"
1"	1"	Pieza	US 1"x1"
1-1/16"	1"	Pieza	US 1-1/16"x1"
1-1/8"	1"	Pieza	US 1-1/8"x1"
1-3/16"	1"	Pieza	US 1-3/16"x1"
1-1/4"	1"	Pieza	US 1-1/4"x1"
1-5/16"	1"	Pieza	US 1-5/16"x1"
1-3/8"	1"	Pieza	US 1-3/8"x1"
1-7/16"	1"	Pieza	US 1-7/16"x1"
1-1/2"	1"	Pieza	US 1-1/2"x1"
1-9/16"	1"	Pieza	US 1-9/16"x1"
1-5/8"	1"	Pieza	US 1-5/8"x1"
1-11/16"	1"	Pieza	US 1-11/16"x1"
1-3/4"	1"	Pieza	US 1-3/4"x1"
1-13/16"	1"	Pieza	US 1-13/16"x1"
1-7/8"	1"	Pieza	US 1-7/8"x1"
1-15/16"	1"	Pieza	US 1-15/16"x1"
2"	1"	Pieza	US 2"x1"

Cortadores anulares HSS 2"
Para taladros magnéticos



Diámetro	Longitud	Unidad	No. Parte
7/16"	2"	Pieza	US 7/16"x2"
1/2"	2"	Pieza	US 1/2"x2"
9/16"	2"	Pieza	US 9/16"x2"
5/8"	2"	Pieza	US 5/8"x2"
11/16"	2"	Pieza	US 11/16"x2"
3/4"	2"	Pieza	US 3/4"x2"
13/16"	2"	Pieza	US 13/16"x2"
7/8"	2"	Pieza	US 7/8"x2"
15/16"	2"	Pieza	US 15/16"x2"
1"	2"	Pieza	US 1"x2"
1-1/16"	2"	Pieza	US 1-1/16"x2"
1-1/8"	2"	Pieza	US 1-1/8"x2"
1-3/16"	2"	Pieza	US 1-3/16"x2"
1-1/4"	2"	Pieza	US 1-1/4"x2"
1-5/16"	2"	Pieza	US 1-5/16"x2"
1-3/8"	2"	Pieza	US 1-3/8"x2"
1-7/16"	2"	Pieza	US 1-7/16"x2"
1-1/2"	2"	Pieza	US 1-1/2"x2"
1-9/16"	2"	Pieza	US 1-9/16"x2"
1-5/8"	2"	Pieza	US 1-5/8"x2"
1-11/16"	2"	Pieza	US 1-11/16"x2"
1-3/4"	2"	Pieza	US 1-3/4"x2"
1-13/16"	2"	Pieza	US 1-13/16"x2"
1-7/8"	2"	Pieza	US 1-7/8"x2"
1-15/16"	2"	Pieza	US 1-15/16"x2"
2"	2"	Pieza	US 2"x2"

Cortadores anulares carburo de tungsteno Taladro magnético



Cortadores anulares con insertos de carburo de tungsteno
Para cortes de alta velocidad

Ideales para perforar acero con óxido o pintura inoxidable

Duran más que los cortadores de acero de alta velocidad

** Utilice RPM altas para un mejor resultado*

Cortadores anulares de carburo 1-3/8"

Diámetro	Longitud	Usar con piloto	Piezas por empaque	No. Parte
1/2"	1-3/8"	PILOT U1A	1	UPC 14S
9/16"	1-3/8"	PILOT U1A	1	UPC 15S
5/8"	1-3/8"	PILOT U1A	1	UPC 16S
11/16"	1-3/8"	PILOT U1B	1	UPC 18S
3/4"	1-3/8"	PILOT U1B	1	UPC 19S
13/16"	1-3/8"	PILOT U1B	1	UPC 21S
7/8"	1-3/8"	PILOT U1B	1	UPC 23S
15/16"	1-3/8"	PILOT U1B	1	UPC 24S
1"	1-3/8"	PILOT U1B	1	UPC 26S
1-1/16"	1-3/8"	PILOT U1B	1	UPC 27S
1-1/8"	1-3/8"	PILOT U1B	1	UPC 29S
1-3/16"	1-3/8"	PILOT U1B	1	UPC 31S
1-1/4"	1-3/8"	PILOT U1B	1	UPC 32S
1-5/16"	1-3/8"	PILOT U1B	1	UPC 34S
1-3/8"	1-3/8"	PILOT U2B	1	UPC 35S
1-7/16"	1-3/8"	PILOT U2B	1	UPC 37S
1-1/2"	1-3/8"	PILOT U1B	1	UPC 38S
1-9/16"	1-3/8"	PILOT U1B	1	UPC 40S
1-5/8"	1-3/8"	PILOT U1B	1	UPC 42S
1-11/16"	1-3/8"	PILOT U1B	1	UPC 43S
1-3/4"	1-3/8"	PILOT U1B	1	UPC 45S
1-13/16"	1-3/8"	PILOT U1B	1	UPC 46S
1-7/8"	1-3/8"	PILOT U1B	1	UPC 48S
1-15/16"	1-3/8"	PILOT U1B	1	UPC 50S
2"	1-3/8"	PILOT U1B	1	UPC 51S
2-1/16"	1-3/8"	PILOT U1B	1	UPC 52S
2-1/8"	1-3/8"	PILOT U1B	1	UPC 54S
2-3/16"	1-3/8"	PILOT U1B	1	UPC 55S
2-1/4"	1-3/8"	PILOT U1B	1	UPC 57S
2-5/16"	1-3/8"	PILOT U1B	1	UPC 59S
2-3/8"	1-3/8"	PILOT U1B	1	UPC 60S

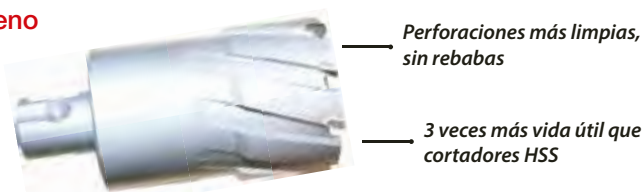

Cortadores anulares de carburo 2-3/16"

Diámetro	Longitud	Usar con piloto	Piezas por empaque	No. Parte
1/2"	2-3/16"	PILOT U2A	1	UPC 14L
9/16"	2-3/16"	PILOT U2A	1	UPC15L
5/8"	2-3/16"	PILOT U2A	1	UPC 16L
11/16"	2-3/16"	PILOT U2B	1	UPC 18L
3/4"	2-3/16"	PILOT U2B	1	UPC 19L
13/16"	2-3/16"	PILOT U2B	1	UPC 21L
7/8"	2-3/16"	PILOT U2B	1	UPC 23L
15/16"	2-3/16"	PILOT U2B	1	UPC 24L
1"	2-3/16"	PILOT U2B	1	UPC 26L
1-1/16"	2-3/16"	PILOT U2B	1	UPC 27L
1-1/8"	2-3/16"	PILOT U2B	1	UPC 29L
1-3/16"	2-3/16"	PILOT U2B	1	UPC 31L
1-1/4"	2-3/16"	PILOT U2B	1	UPC 32L
1-5/16"	2-3/16"	PILOT U2B	1	UPC 34L
1-3/8"	2-3/16"	PILOT U2B	1	UPC 35L
1-7/16"	2-3/16"	PILOT U2B	1	UPC 37L
1-1/2"	2-3/16"	PILOT U2B	1	UPC 38L
1-9/16"	2-3/16"	PILOT U2B	1	UPC 40L
1-5/8"	2-3/16"	PILOT U2B	1	UPC 42L
1-11/16"	2-3/16"	PILOT U2B	1	UPC 43L
1-13/16"	2-3/16"	PILOT U2B	1	UPC 46L
1-7/8"	2-3/16"	PILOT U2B	1	UPC 48L
1-15/16"	2-3/16"	PILOT U2B	1	UPC 50L
2-1/16"	2-3/16"	PILOT U2B	1	UPC 51L
2-1/8"	2-3/16"	PILOT U2B	1	UPC 53L
2-3/16"	2-3/16"	PILOT U2B	1	UPC 55L
2-1/4"	2-3/16"	PILOT U2B	1	UPC 57L
2-5/16"	2-3/16"	PILOT U2B	1	UPC 59L
2-3/8"	2-3/16"	PILOT U2B	1	UPC 60L

Cortadores anulares cobalto

Taladro magnético



Ideales para perforaciones en acero al carbón inoxidable y aceros de alta resistencia

* Utilice RPM altas para un mejor resultado



Perforaciones más limpias, sin rebabas

3 veces más vida útil que cortadores HSS









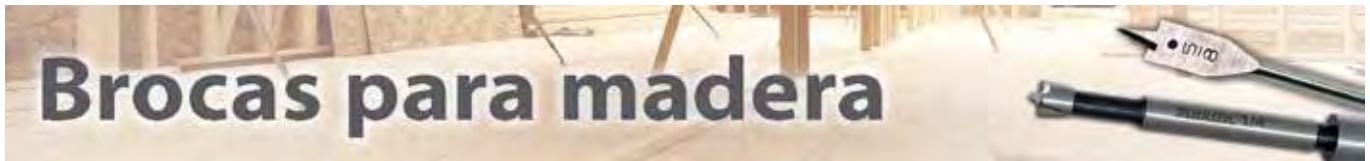







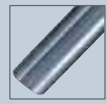





Cortadores anulares HSS-Co 1"

Diámetro	Longitud	Usar con piloto	Piezas por empaque	No. Parte
7/16"	1"	PILOT S12	1	MUS 7/16X1
1/2"	1"	PILOT S12	1	MUS 1/2X1
9/16"	1"	PILOT S12	1	MUS 9/16X1
5/8"	1"	PILOT S12	1	MUS 5/8X1
11/16"	1"	PILOT S12	1	MUS 11/16X1
3/4"	1"	PILOT S12	1	MUS 3/4X1
13/16"	1"	PILOT S12	1	MUS 13/16X1
7/8"	1"	PILOT S12	1	MUS 7/8X1
15/16"	1"	PILOT S12	1	MUS 15/16X1
1"	1"	PILOT S12	1	MUS 1X1
1-1/16"	1"	PILOT S12	1	MUS 1-1/16X1
1-1/8"	1"	PILOT S12	1	MUS 1-1/8X1
1-3/16"	1"	PILOT S12	1	MUS 1-3/16X1
1-1/4"	1"	PILOT S12	1	MUS 1-1/4X1
1-5/16"	1"	PILOT S12	1	MUS 1-5/16X1
1-3/8"	1"	PILOT S12	1	MUS 1-3/8X1
1-7/16"	1"	PILOT S12	1	MUS 1-7/16X1
1-1/2"	1"	PILOT S12	1	MUS 1-1/2X1
1-9/16"	1"	PILOT S12	1	MUS 1-9/16X1
1-5/8"	1"	PILOT S12	1	MUS 1-5/8X1
1-11/16"	1"	PILOT S12	1	MUS 1-11/16X1
1-3/4"	1"	PILOT S12	1	MUS 1-3/4X1
1-13/16"	1"	PILOT S12	1	MUS 1-13/16X1
1-7/8"	1"	PILOT S12	1	MUS 1-7/8X1
1-15/16"	1"	PILOT S12	1	MUS 1-15/16X1
2"	1"	PILOT S12	1	MUS 2X1
2-1/16"	1"	PILOT S12	1	MUS 2-1/16X1
2-1/8"	1"	PILOT S12	1	MUS 2-1/8X1
2-3/16"	1"	PILOT S12	1	MUS 2-3/16X1
2-1/4"	1"	PILOT S12	1	MUS 2-1/4X1
2-5/16"	1"	PILOT S12	1	MUS 2-5/16X1
2-3/8"	1"	PILOT S12	1	MUS 2-3/8X1

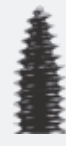
Cortadores anulares HSS-Co 2"

Diámetro	Longitud	Usar con piloto	Piezas por empaque	No. Parte
7/16"	2"	PILOT L12	1	MUS 7/16X2
1/2"	2"	PILOT L12	1	MUS 1/2X2
9/16"	2"	PILOT L12	1	MUS 9/16X2
5/8"	2"	PILOT L12	1	MUS 5/8X2
11/16"	2"	PILOT L12	1	MUS 11/16X2
3/4"	2"	PILOT L12	1	MUS 3/4X2
13/16"	2"	PILOT L12	1	MUS 13/16X2
7/8"	2"	PILOT L12	1	MUS 7/8X2
15/16"	2"	PILOT L12	1	MUS 15/16X2
1"	2"	PILOT L12	1	MUS 1X2
1-1/16"	2"	PILOT L12	1	MUS 1-1/16X2
1-1/8"	2"	PILOT L12	1	MUS 1-1/8X2
1-3/16"	2"	PILOT L12	1	MUS 1-3/16X2
1-1/4"	2"	PILOT L12	1	MUS 1-1/4X2
1-5/16"	2"	PILOT L12	1	MUS 1-5/16X2
1-3/8"	2"	PILOT L12	1	MUS 1-3/8X2
1-7/16"	2"	PILOT L12	1	MUS 1-7/16X2
1-1/2"	2"	PILOT L12	1	MUS 1-1/2X2
1-9/16"	2"	PILOT L12	1	MUS 1-9/16X2
1-5/8"	2"	PILOT L12	1	MUS 1-5/8X2
1-11/16"	2"	PILOT L12	1	MUS 1-11/16X2
1-3/4"	2"	PILOT L12	1	MUS 1-3/4X2
1-13/16"	2"	PILOT L12	1	MUS 1-13/16X2
1-7/8"	2"	PILOT L12	1	MUS 1-7/8X2
1-15/16"	2"	PILOT L12	1	MUS 1-15/16X2
2"	2"	PILOT L12	1	MUS 2X2
2-1/16"	2"	PILOT L12	1	MUS 2-1/16X2
2-1/8"	2"	PILOT L12	1	MUS 2-1/8X2
2-3/16"	2"	PILOT L12	1	MUS 2-3/16X2
2-1/4"	2"	PILOT L12	1	MUS 2-1/4X2
2-5/16"	2"	PILOT L12	1	MUS 2-5/16X2
2-3/8"	2"	PILOT L12	1	MUS 2-3/8X2



Descripción	A	B	C
	Punta	Zanco	Diámetro
Broca manita  <p>Adecuado para perforaciones de diámetro mediano y grande en madera suave o plástico blando. No es tan exacto como la broca para madera pero es razonable.</p>	Punta brad 	Recto 	6 - 36mm 1/4" - 1-1/2"
		1/4" Hex 	1/4" - 1-1/4"
Broca para madera  <p>Esta es la Broca más popular en perforación para madera de diámetro pequeño a mediano. Capaz de perforar diversos plásticos blandos y madera en general.</p>	Punta brad 	Recto 	3 - 20mm 1/8" - 3/4"
		1/4" Hex 	3 - 15mm
Broca auger tipo berbiquí  <p>Adecuado para perforaciones profundas con diámetros medianos y grandes. La parte superior en forma de berbiquí requiere muy poca presión. Comparado con la punta plana o broca para madera, cortando la superficie suavemente.</p>	Cuerda auger 	Recto 	6 - 30mm 1/4" - 1-1/4"
		1/4" Hex 	6 - 21mm
Broca auger tipo berbiquí  <p>Adecuado para perforar madera con clavos que no pueden perforar con un solo mástil. Por ejemplo en materiales de construcción y vigas de madera.</p>	Cuerda auger 	5/16" 7/16" Hex 	10 - 38mm 3/8" - 1-1/2"
		7/16" Hex 	1" - 3"
Broca de corona  <p>Adecuado para perforaciones de gran diámetro en madera. La parte superior es de tipo auger y requiere muy poca presión. Especial para tablaroca.</p>	Cuerda auger 	7/16" Hex 	1" - 3"
		Recto 	10 - 50mm 1/4" - 2 -1/8"
Broca forstner  <p>Es adecuado para la perforación ciega o penetrante de diámetro de tamaño mediano a grande con alta calidad, por ejemplo: Cocinas integrales en bisagras bidimensionales</p>	Broca Brad (corta) 	Recto 	10 - 50mm 1/4" - 2 -1/8"

Broca tipo manita (espada)



Medida: Pulgadas

Diámetro	Longitud total	No. Parte
1/4"	6"	D-24505
5/16"	6"	D-24511
3/8"	6"	D-24527
7/16"	6"	D-24533
1/2"	6"	D-26490
9/16"	6"	D-24549
5/8"	6"	D-24561
11/16"	6"	D-24577
3/4"	6"	D-24583
7/8"	6"	D-24599
15/16"	6"	D-24608
1"	6"	D-24614
1-1/8"	6-1/2"	D-24636
1-1/4"	6-1/2"	D-24658
1-3/8"	6-1/2"	D-24670
1-1/2"	6-1/2"	D-26509

Brocas espirales con punta guía



Medida: Pulgadas

Diámetro	Longitud total	Longitud trabajo	No. Parte
1/8"	2-3/4"	1-5/16"	D-23189
5/32"	3-1/8"	1-3/4"	D-23195
3/16"	3-1/2"	2"	D-23204
1/4"	4"	2-9/16"	D-23210
9/32"	4-1/4"	2-3/4"	D-23226
5/16"	4-1/2"	3"	D-23232
11/32"	4-3/4"	3"	D-23248
3/8"	5-1/8"	3-11/32"	D-23254
7/16"	5-5/8"	3-3/4"	D-23260
1/2"	6-5/8"	3-3/4"	D-23276
5/8"	7"	4-3/4"	D-23282
11/16"	8"	5-7/8"	D-23298
3/4"	8"	5-7/8"	D-23307

Brocas tipo manita zanco Hex 1/4"



Diámetro	Longitud total	Zanco tipo	Empaque Piezas	Part No.
1/4"	6"	MZ	1	D-23955
3/8"	6"	MZ	1	D-23961
1/2"	6"	MZ	1	D-23977
5/8"	6"	MZ	1	D-23983
3/4"	6"	MZ	1	D-23999
7/8"	6"	MZ	1	D-24000
1"	6"	MZ	1	D-24016
1-1/4"	6"	MZ	1	D-24022

Brocas autoalimentables para madera

Broca corona



Diámetro	Zanco	No. Parte
1"	HEX. 7/16"	D-29935
1-1/8"	HEX. 7/16"	D-29957
1-1/4"	HEX. 7/16"	D-29963
1-3/8"	HEX. 7/16"	D-29979
1-1/2"	HEX. 7/16"	D-29985
1-3/4"	HEX. 7/16"	D-29991
2"	HEX. 7/16"	D-30003
2-1/8"	HEX. 7/16"	D-30019
2-1/4"	HEX. 7/16"	D-30025
2-9/16"	HEX. 7/16"	D-30031
3"	HEX. 7/16"	D-30047
3-5/8"	HEX. 7/16"	D-56518
4-5/8"	HEX. 7/16"	D-56524

Juego de brocas espirales con punta guía



Piezas	No. Parte
5 pzs. (3, 5, 6, 7, 8mm)	D-57211
8 pzs. (3, 4, 5, 6, 7, 8, 9, 10mm)	D-57227



Brocas auger tipo berbiquí con zanco recto



Medida: Pulgadas

Diámetro	Longitud total	Longitud trabajo	No. Parte
1/4"	8"	5-1/8"	D-23313
5/16"	8"	5-1/8"	D-23329
3/8"	8"	5-1/8"	D-23335
1/2"	8"	5-1/8"	D-23341
9/16"	8"	5-1/8"	D-23357
5/8"	8"	5-1/8"	D-23363
11/16"	8"	5-1/8"	D-23379
3/4"	8"	5-1/8"	D-23385

Brocas auger tipo berbiquí con zanco recto



Medida: Pulgadas

Diámetro	Longitud total	Longitud trabajo	No. Parte
7/8"	8"	5-1/8"	D-23391
15/16"	8"	5-1/8"	D-23400
1/4"	10"	7"	D-23416
5/16"	10"	7"	D-23422
3/8"	10"	7"	D-23438
1/2"	10"	7"	D-23444
9/16"	10"	7"	D-23450
5/8"	10"	7"	D-23466
11/16"	10"	7"	D-23472
3/4"	10"	7"	D-23488
7/8"	10"	7"	D-23494
15/16"	10"	7"	D-23503
5/16"	16"	13"	D-23519
3/8"	16"	13"	D-23525
1/2"	16"	13"	D-23531
9/16"	16"	13"	D-23547
5/8"	16"	13"	D-23553
11/16"	16"	13"	D-23569
3/4"	16"	13"	D-23575
7/8"	16"	13"	D-23581
15/16"	16"	13"	D-23597
1"	16"	13"	D-23606
1-1/8"	16"	13"	D-23612

Brocas auger tipo berbiquí zanco 7/16"Hex.

* Zanco Hex 5/16"

Tipo de corte clavo



Medida: Pulgadas

Diámetro	Longitud total	Longitud trabajo	No. Parte
3/8"	6"	3-1/2"	*D-35673
7/16"	6"	3-1/2"	*D-35689
1/2"	6"	3-1/2"	*D-35695
9/16"	6"	3-1/2"	D-35704
5/8"	6"	3-1/2"	D-35710
11/16"	6"	3-1/2"	D-35726
3/4"	6"	3-1/2"	D-35732
13/16"	6"	3-1/2"	D-35748
7/8"	6"	3-1/2"	D-35754
15/16"	6"	3-1/2"	D-35760
1"	6"	3-1/2"	D-35776
1-1/16"	6"	3-1/2"	D-35782
1-1/8"	6"	3-1/2"	D-35798
1-1/4"	6"	3-1/2"	D-35807
1-3/8"	6"	3-1/2"	D-35813
1-1/2"	6"	3-1/2"	D-35829
3/8"	18"	15"	D-35835
7/16"	18"	15"	D-35841
1/2"	18"	15"	D-35857

Brocas auger tipo berbiquí zanco 7/16"Hex.

* Zanco Hex 5/16"

Tipo de corte clavo



Medida: Pulgadas

Diámetro	Longitud total	Longitud trabajo	No. Parte
9/16"	18"	15"	D-35863
5/8"	18"	15"	D-35879
11/16"	18"	15"	D-35885
3/4"	18"	15"	D-35891
13/16"	18"	15"	D-35900
7/8"	18"	15"	D-35916
15/16"	18"	15"	D-35922
1"	18"	15"	D-35938
1-1/16"	18"	15"	D-35944
1-1/8"	18"	15"	D-35950
1-1/4"	18"	15"	D-35966
1-3/8"	18"	15"	D-35972
1-1/2"	18"	15"	D-35988

Corta círculos ajustable

Corta madera delgada, triplay, panel de yeso, plástico

Medida: Pulgadas

Diámetro	Vástago	No. Parte
30-120mm	3/8"	D-57093
30-200mm	3/8"	D-57102
Repuesto de corta círculos (2 piezas)		D-57118

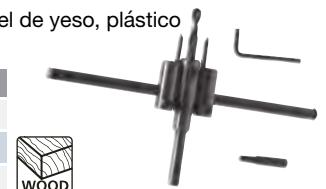

Brocas auger tipo berbiquí zanco 7/16"Hex.

* Zanco Hex 5/16"

Tipo de corte clavo



Medida: Pulgadas

Diámetro	Longitud total	Longitud trabajo	No. Parte
3/8"	6"	3-1/2"	*D-35673
7/16"	6"	3-1/2"	*D-35689
1/2"	6"	3-1/2"	*D-35695
9/16"	6"	3-1/2"	D-35704
5/8"	6"	3-1/2"	D-35710
11/16"	6"	3-1/2"	D-35726
3/4"	6"	3-1/2"	D-35732
13/16"	6"	3-1/2"	D-35748
7/8"	6"	3-1/2"	D-35754
15/16"	6"	3-1/2"	D-35760
1"	6"	3-1/2"	D-35776
1-1/16"	6"	3-1/2"	D-35782
1-1/8"	6"	3-1/2"	D-35798
1-1/4"	6"	3-1/2"	D-35807
1-3/8"	6"	3-1/2"	D-35813
1-1/2"	6"	3-1/2"	D-35829
3/8"	18"	15"	D-35835
7/16"	18"	15"	D-35841
1/2"	18"	15"	D-35857

Brocas forstner

Ideales para bisagras bidimensionales
En cocinas integrales



Punta centradora para un mejor apoyo en la perforación

Medida marcada en la broca



D-50588

Cortadores precisos para perforaciones limpias

Ideal para:



Vástago 3/8" HSS



Ver video



Medida: Pulgadas

Diámetro	Vástago	Longitud de trabajo	No. Parte
1/4"	3/8"	3-1/8"	D-50588
3/8"	3/8"	3-1/8"	D-50594
1/2"	3/8"	3-1/8"	D-50603
5/8"	3/8"	3-1/8"	D-50619
3/4"	3/8"	3-1/8"	D-50625
7/8"	3/8"	3-1/8"	D-50631
1"	3/8"	3-1/8"	D-50647
1 1/8"	3/8"	3-1/8"	D-50653
1 1/4"	3/8"	3-1/8"	D-50669
1 3/8"	3/8"	3-1/8"	D-50675
1 1/2"	3/8"	3-1/8"	D-50681
1 5/8"	3/8"	3-1/8"	D-50697
1 3/4"	3/8"	3-1/8"	D-50706
1 7/8"	3/8"	3-1/8"	D-50712
2"	3/8"	3-1/8"	D-50728
2 1/8"	3/8"	3-1/8"	D-50734

Brocas de avellanado para Madera

Avellanadores de cambio rápido con punta para atornillar

NUEVO



Repuesto de avellanador

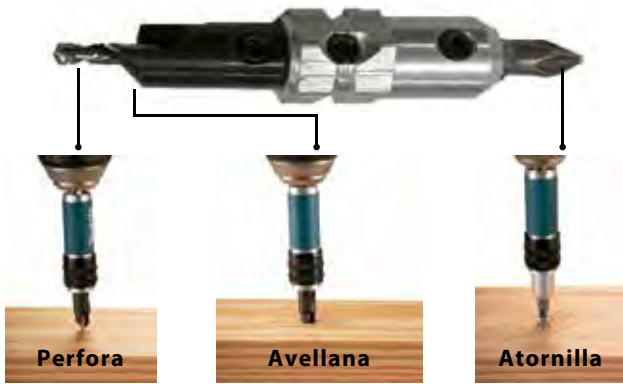

COMO REALIZAR EL CAMBIO RÁPIDO AVELLANADOR-PUNTA



Deslice la vaina hacia el lado de la broca y suelte el bloqueo

- Desinstale la parte de la broca y vuelva a instalarla invirtiendo la forma
- Deslice la manga hacia el lado del cuerpo para bloquearla (nota: asegúrese de que esté bloqueada cuando esté colocada)



Bloqueado Desbloqueado

Como quitar la broca:

- Retire el tornillo de fijación de cabeza hueca hexagonal con la llave hexagonal en la parte posterior del cuerpo
- Reemplazar la broca de tornillo
- Quitar este tornillo en el lado de la broca del tornillo
- Reemplace el taladro y la broca avellanadora
- Quitar este tornillo en el medio



Tamaño del avellanador	Tamaño de la punta	Diámetro de la broca	Tipo	Empaque Piezas	No. Parte
No. 6 (M3)	PH2	3/32" (2.4mm)	Cambio rápido	1pz	D-73209
No. 8 (M4)	PH2	7/64" (2.8mm)	Cambio rápido	1pz	D-73215
No. 10 (M5)	PH2	1/8" (3.2mm)	Cambio rápido	1pz	D-73221
No. 6 (M3)	-	3/32" (2.4mm)	Repuesto Avellanador	1pz	D-73237
No. 8 (M4)	-	7/64" (2.8mm)	Repuesto Avellanador	1pz	D-73243
No. 10 (M5)	-	1/8" (3.2mm)	Repuesto Avellanador	1pz	D-73259

Brocas de avellanado para Madera

Juego de avellanadora

Brocas más llave hexagonal 4 pzs.

NUEVO

No. Parte D-73455



Tamaño del avellanador	Profundidad de perforación		Diámetro de la broca	Empaque Piezas	No. Parte
	Mínima	Máxima			
No. 6 (M3)	11mm	31mm	3/32" (2.4mm)	4 pzs más llave.	D-73455
No. 8 (M4)	18mm	38mm	7/64" (2.8mm)		
No. 10 (M5)	22mm	41mm	1/8" (3.2mm)		
No. 12 (M6)	26mm	45mm	9/64" (3.6mm)		

Juego de avellanadora

Brocas más llave hexagonal



Ver video



Mayor adherencia entre el orificio guía y el tornillo



Fácil ajuste del avellanador y cambio de broca

Medida: Pulgadas

Dimensiones	Longitud	Empaque Piezas	Aplicación	No. Parte
9/64"	#6	3 llave Hex.		A-99661
11/64"	#8			
3/16"	#10			
9/64"	#6	1 / llave Hex.		A-99677
11/64"	#8	1 / llave Hex.		A-99683
3/16"	#10	1 / llave Hex.		A-99699
7/32"	#12	1 / llave Hex.		A-99708
9/64"	#6	1	Repuesto	A-99714
11/64"	#8	1	Repuesto	A-99720
3/16"	#10	1	Repuesto	A-99736
7/32"	#12	1	Repuesto	A-99742

Ezychange BiM



Multi propósito dientes de carburo

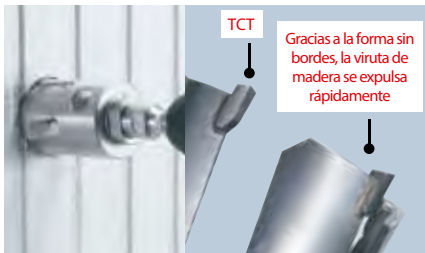

Gráfica de material

Aplicación	Metal	Acero inoxidable	Aluminio	ferrosos	Madera	MDF	Tabla roca	PVC	Fibra de vidrio	Azulejo	Ladrillo	Ladrillo hueco	Mármol	Granito	Vidrio	Cerámica
Brocasieras																
<i>Ezychange</i>	AA	A	AA	AA	A			AA								
Brocasieras bimetalicas	AA		A	A	AA			AA								
Bimetalica Sheet metal	AA	AA	A	A												
Brocasieras Multipropósito TCT					AA	AA	AA	AA	AA	A	A	AA				
Brocasieras grano carburo de tungsteno											AA	AA				
Brocasieras de diamante										AA	AA	AA	AA			
Brocasieras de diamante electrodepositado										AA			AA	AA	AA	AA
Aplicación / consejos	El uso de corte/aceite	Baja velocidad, utilice cortadora / aceite	El uso de corte/aceite	El uso de corte/aceite									Uso en humedo	Uso en humedo	Uso en humedo	Uso en humedo

BiM perforación



Grano de carburo de tungsteno

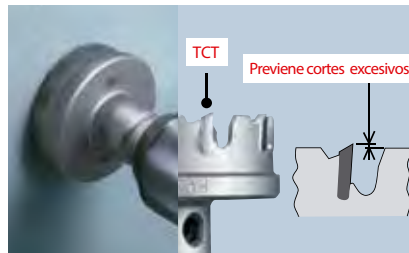

BiM hoja de metal



Brocasieras de diamante electrodepositado



AA :Recomendable

A :Aceptable

Brocasieras "bimetálicas"



Diámetro	No. Parte	Diámetro	No. Parte
5/8", (16mm)	D-21618	2-1/8", (54mm)	D-24907
3/4", (19mm)	D-21624	2-1/4", (57mm)	D-21749
25/32", (20mm)	D-21630	2-1/2", (64mm)	D-24913
7/8", (22mm)	D-21646	2-11/16", (68mm)	D-21755
15/16", (24mm)	D-21652	2-3/4", (70mm)	D-24935
1", (25mm)	D-21668	3", (76mm)	D-21761
1-1/8", (29mm)	D-21674	3-1/4", (83mm)	D-21777
1-1/4", (32mm)	D-21680	3-1/2", (89mm)	D-24941
1-3/8", (35mm)	D-21696	3-5/8", (92mm)	D-21783
1-1/2", (38mm)	D-21705	4", (102mm)	D-24957
1-9/16", (40mm)	D-21711	4-1/8", (105mm)	D-21799
1-3/4", (44mm)	D-21727	5", (127mm)	D-21808
2", (51mm)	D-21733	6", (152mm)	D-21814

Brocasieras "Ezychange" bimetálica cambio fácil

Perforaciones en madera, aluminio y PVC

Cambio de piloto y brocasieras sin herramienta (diámetro.14-152mm) en el adaptador Ezychange.

NUEVO



Accesorios para brocasieras Bi-metal



	Aplicación	Se adapta a	No. Parte
Adaptador con broca guía	Para taladros 3/8"	9/16" - 1-1/8"	D-21820
	Para taladros 7/16"	1-1/4" - 6"	D-21836
	Para martillos SDS-Plus	9/16" - 1-1/8"	D-21842
Broca piloto	Longitud 2-3/4"	Todas	D-21864

Accesorios para brocasieras "Ezychange Bi Metálica" cambio fácil

NUEVO

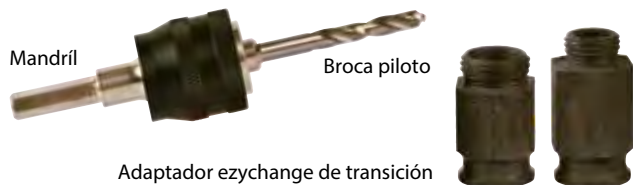

Descripción	No. Parte
Mandril Ezychange con broca HSS-G	E-04070
Broca piloto HSS-G	E-04086
Broca piloto HSS-Co	E-04092
Adaptador Ezychange de transición 14-30mm x 3pcs // 32-152mm x 3pcs	B-16271

Ezychange



Ver video



Diámetro	No. Parte	Diámetro	No. Parte
5/8" (16mm)	E-03632	2-3/16" (56mm)	E-03850
11/16" (17mm)	E-03648	2-1/4" (57mm)	E-03866
3/4" (19mm)	E-03654	2-3/8" (60mm)	E-03872
25/32" (20mm)	E-03660	2-1/2" (64mm)	E-03888
7/8" (22mm)	E-03676	2-9/16" (65mm)	E-03894
15/16" (24mm)	E-03682	2-11/16" (68mm)	E-03903
1" (25mm)	E-03698	2-3/4" (70mm)	E-03919
1-1/16" (27mm)	E-03707	2-7/8" (73mm)	E-03925
1-1/8" (29mm)	E-03713	3" (76mm)	E-03931
1-3/16" (30mm)	E-03729	3-1/8" (79mm)	E-03947
1-1/4" (32mm)	E-03735	3-1/4" (83mm)	E-03953
1-3/8" (35mm)	E-03741	(86mm)	E-03969
1-7/16" (37mm)	E-03757	3-5/8" (92mm)	E-03975
1-1/2" (38mm)	E-03763	(95mm)	E-03981
1-9/16" (40mm)	E-03779	4" (102mm)	E-03997 / B-11499
1-5/8" (41mm)	E-03785	4-1/8" (105mm)	E-04008 / B11508
1-3/4" (44mm)	E-03791	(111mm)	E-04014
1-11/16" (46mm)	E-03800	(114mm)	E-04020
1-7/8" (48mm)	E-03816	(121mm)	E-04036
2", (51mm)	E-03822	5" (127mm)	E-04042 / B-11514
2-1/16" (52mm)	E-03838	(140mm)	E-04058
2-1/8", (54mm)	E-03844	6" (152mm)	E-04064 / B-11520

Brocasieras "Ezychange" bimetálica cambio fácil

Perforaciones en madera, aluminio y PVC

Cambio de piloto y brocasieras sin herramienta (diámetro.14-152mm) en el adaptador Ezychange.



Ezychange

 **Ver video**



Diámetro	No. Parte	Diámetro	No. Parte
5/8", (16mm)	B-11265	1-7/8", (48mm)	B-11396
3/4", (19mm)	B-11271	2", (51mm)	B-11405
25/32", (20mm)	B-11287	2-3/16", (56mm)	B-31756
15/16", (24mm)	B-11302	2-1/4", (57mm)	B-11411
1-1/16", (27mm)	B-31712	2-1/2", (64mm)	B-11433
1-1/8", (29mm)	B-11324	2-9/16", (65mm)	B-16760
1-3/16", (30mm)	B-11330	2-11/16", (68mm)	B-11449
1-1/4", (32mm)	B-11346	2-3/4", (70mm)	B-11455
1-3/8", (35mm)	B-11352	2-7/8", (73mm)	B-31762
1-7/16", (37mm)	B-31728	3", (76mm)	B-11461
1-1/2", (38mm)	B-11368	3-1/8", (79mm)	B-31778
1-9/16", (40mm)	B-16754	3-1/4", (83mm)	B-11477
1-5/8", (41mm)	B-11374	3-5/8", (92mm)	B-11483
1-3/4", (44mm)	B-11380		

Brocasieras "Sheet metal"



Diámetro	No. Parte	Diámetro	No. Parte
5/8", (16mm)	B-29670	2", (51mm)	B-29854
11/16", (17mm)	B-29686	2-1/8", (54mm)	B-29860
3/4", (19mm)	B-29692	2-1/4", (57mm)	B-29876
25/32", (20mm)	B-29701	2-3/8", (60mm)	B-29882
13/16", (21mm)	B-29717	2-1/2", (63mm)	B-29898
7/8", (22mm)	B-29723	2-9/16", (64mm)	B-35994
1", (25mm)	B-29739	2-5/8", (67mm)	B-36005
1-1/16", (27mm)	B-29745	2-11/16", (68mm)	B-36011
1-1/8", (29mm)	B-29751	2-3/4", (70mm)	B-36027
1-3/16", (30mm)	B-29767	2-7/8", (73mm)	B-36033
1-1/4", (32mm)	B-29773	3", (76mm)	B-36049
1-5/16", (33mm)	B-29789	3-1/8", (79mm)	B-36055
1-3/8", (35mm)	B-29795	3-1/4", (83mm)	B-36061
1-1/2", (38mm)	B-29804	3-3/8", (86mm)	B-36077
1-9/16", (40mm)	B-29810	3-1/2", (89mm)	B-36083
1-5/8", (41mm)	B-29826	4", (102mm)	B-36099
1-3/4", (44mm)	B-29832	5", (127mm)	B-36108
1-7/8", (48mm)	B-29848	6", (152mm)	B-36114

Accesorios para brocasieras "Sheet metal"

Adaptador para broca piloto HSS



Broca piloto



Aplicación	Se adapta a	No. Parte
Adaptador para broca piloto		
Para broca 10mm	16 - 35mm	B-36120
Para broca 13mm	38 - 152mm	B-36136
Broca piloto		
Largo 60mm	Todas	B-36142

El equipo estándar (accesorios), las especificaciones y las fotografías pueden variar. Los accesorios pueden no estar incluidos desde origen con las herramientas, aunque se indiquen en este catálogo.

Brocasieras "Multi propósito TCT"

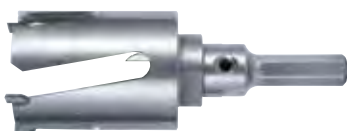

Diámetro	No. Parte	Diámetro	No. Parte
3/4",19mm	D-42678	1-1/2",38mm	D-42743
7/8",22mm	D-42684	2",51mm	D-42793
1",25mm	D-42690	2-1/4",57mm	D-42824
1-1/8",29mm	D-42709	2-9/16",65mm	D-42846
1-1/4",32mm	D-42721	2-11/16",68mm	D-42874

Accesorios para brocasieras "Multi propósito TCT"

Para broca 13mm



Adaptador SDS Plus



Aplicación	Tipo de Broca Piloto	Se Adapta a	No. Parte
------------	----------------------	-------------	-----------

Adaptador para broca piloto

Para broca 13mm	TCT	22-105mm	D-50332
Para broca 13mm	TCT	19mm	D-50354
Árbol SDS Plus	TCT	19mm	D-50360
Para broca 13mm	HSS	22-105mm	D-50376
Árbol SDS Plus	HSS	22-32mm	D-50382
para broca 13mm	HSS	19mm	D-50398

Broca piloto

8mmx100mm	HSS	22-105mm	D-50413
10x100mm	TCT	22-105mm	D-50429
6.35x90mm	HSS	19mm	D-50435
8x90mm	TCT	19mm	D-50441

Brocasieras "carburo de tungsteno"



Diámetro	No. Parte	Diámetro	No. Parte
1-5/16" (33mm)	D-51188	2-7/8" (73mm)	D-51231
1-3/4" (43mm)	D-51194	3-1/4" (83mm)	D-51247
2-3/32"	D-51203	7/16" hex Whith 90mm broca piloto	D-51253
2-1/2" (63mm)	D-51219	90mm broca piloto	D-51269
2-11/16" (67mm)	D-51225		

Brocasieras "diamante electrodepositado"



Diámetro	No. Parte	Diámetro	No. Parte
5/8" (16mm)	B-45995	2-1/8" (53mm)	B-46084
3/4" (19mm)	B-46006	2-1/4" (57mm)	B-46090
1" (25mm)	B-46012	2-1/2" (64mm)	B-46109
1-3/16" (30mm)	B-46028	Zanco largo 182mm(M12)con broca (Broca centradora)	B-46115
1-1/4" (32mm)	B-46034	Zanco largo 182mm(M12)	B-46137
1-3/8" (35mm)	B-46040	Zanco largo 182mm SDS-PLUS c/ broca centradora	B-52691
1-1/2" (38mm)	B-46056	Zanco largo 182mm SDS-PLUS	B-52700
1-3/4" (45mm)	B-46062		
2" (50mm)	B-46078		

Brocasieras "diamante electrodepositado" (segmentado) Corte en Humedo



Para: azulejo, granito, mármol, vidrio

Diámetro	No. Parte	Diámetro	No. Parte
3/4", (19mm)	D-61210	2-1/8", (54mm)	D-61329
25/32", (20mm)	D-61226	2-1/4", (57mm)	D-61335
7/8", (22mm)	D-61232	2-3/8", (60mm)	D-61341
1", (25mm)	D-61248	2-9/16", (64mm)	D-61357
1-1/8", (29mm)	D-61254	2-9/16", (65mm)	D-61363
1-1/4", (32mm)	D-61260	2-5/8", (67mm)	D-61379
1-3/8", (35mm)	D-61276	2-11/16", (68mm)	D-61385
1-1/2", (38mm)	D-61282	2-3/4", (70mm)	D-61391
1-5/8", (41mm)	D-61298	3", (76mm)	D-61400
1-3/4", (44mm)	D-61307	3-1/8", (79mm)	D-61416
2", (51mm)	D-61313	3-1/4", (83mm)	D-61422

Accesorios para brocasieras diamante electrodepositado (segmentado)



Aplicación	Se adapta a	No. Parte
Mandril para brocasieras diamante electrodepositado (segmentado)	19 - 29mm	D-61438
Mandril para brocasieras diamante electrodepositado (segmentado)	32 - 83mm	D-61444
Guía retráctil para brocasieras diamante electrodepositado (segmentado)	-	D-61450

Juegos de Brocasieras



Seis medidas comunes para plomeros y electricistas.

A: 11mm (*7/16") adaptador con broca piloto

B: 9.5mm (*3/8") adaptador con broca piloto

C: Resorte de expulsión

Medida: Pulgadas

Surtido de brocasieras Bi-Metal

Incluye brocasieras (1 de cada una)	No. Parte
3/4", 7/8", 1-1/8", 1-1/2", 1-3/4", 2-1/4", adaptador A, adaptador B, Resorte de expulsión	D-21870
5/8", 25/32", 1", 1-1/4", 1-9/16", 2", adaptador A, adaptador B, Resorte de expulsión	D-21886
Juego de instalación de cerradura Brocasieras Bi-metal y juego de brocas tipo manita (BiM 2-1/8", adaptador con broca piloto plano (1"x6"))	D-34350

Surtido de brocasieras Ezychange Bi Metal de cambio fácil

Ver video



Ezychange

Descripción	No. Parte
5/8", 25/32", 1", 1-1/4", 1-9/16", 2", (16, 20, 25, 32, 40, 51mm), adaptador Ezychange, HSS-G taladro de perforación	B-11972
25/32", 1", 1-1/4", 1-9/16", 2", 2-9/16", (20, 25, 32, 40, 51, 65mm), adaptador Ezychange, HSS-G taladro de perforación	B-11988
1", 1-1/4", 1-3/16", 2", 2-9/16", 2-11/16", 3", (25, 32, 40, 51, 65, 68, 76mm), adaptador Ezychange, HSS-G taladro de rotación x2	B-18188

Juegos de Brocasieras

NUEVO



Descripción	Piezas	No. Parte
Juego de brocasieras para fontanero 3/4", 7/8", 1-1/8", 1-1/2", 1-3/4", 2-1/4", (19, 22, 29, 38, 44, 57mm), adaptador con broca piloto 9.5 / 11mm, manual de instrucciones	Estuche con 9 piezas	D-63965
Juego de brocasieras para fontanero 19, 22, 25, 29, 35, 38, 44, 51, 57, 68, 75mm adaptador con broca piloto 9.5 / 11mm, manual de instrucciones	Estuche con 14 piezas	D-63971
Juego de brocasieras para Electricistas 19, 22, 29, 35, 38, 51, 54, 57, 68mm adaptador con broca piloto 9.5 / 11mm, manual de instrucciones	Estuche con 12 piezas	D-63987
Juego de brocasieras universal 16, 19, 22, 25, 29, 32, 35, 37, 44, 51, 57, 64, 68, 76mm adaptador con broca piloto 9.5 / 11mm, manual de instrucciones	Estuche con 16 piezas	D-63993

Juego de brocasieras Ezychange Bi Metal de cambio fácil

NUEVO



Descripción	Piezas por empaque	No. Parte
Estuche para plomero 35, 44, 54, 76, 95, 114mm Adaptador con broca piloto HSS-G, broca piloto HSS-Co	8pzs	E-15796
Estuche para Electricistas 32, 41, 51, 73, 83mm Adaptador con broca piloto HSS-G, broca piloto HSS-Co	7pzs	E-15805
Estuche para uso universal 57, 73, 76, 83, 114, 133mm Adaptador con broca piloto HSS-G, broca piloto HSS-Co	8pzs	E-15780

Despachadores



Medida: Pulgadas

Diámetro	Piezas por Empaque	No. Parte
5/8", (16mm)	16	D-44666 / D-16994
3/4", (19mm)	16	D-44672
7/8", (22mm)	14	D-44694 / D-17011
1", (25mm)	12	D-44719 / D-17033

Surtido de brocasieras multipropósito TCT



Descripción	No. Parte
Set de 9 brocasieras multipropósito TCT, con adaptador, broca piloto y maletín 1-1/8" (29mm), 1-3/8" (35mm), 1-1/2" (38mm), 2-1/4" (57mm), 2-1/2" (64mm), 3" (76mm), broca piloto HSS 4", broca piloto TCT 4", adaptador.	D-51281
Set de 9 brocasieras multipropósito TCT, con adaptador, broca piloto y maletín, 7/8" (22mm), 1" (25.4mm), 1-1/8" (29mm), 1-3/8" (35mm), 1-1/2" (38mm), 1-3/4" (45mm), 2" (54mm) broca piloto HSS 4", broca piloto TCT 4", adaptador	D-51297

Broqueros SDS-Plus



Usar en	Diámetro boca	Diámetro rosca	Detalle	Empaque Piezas	No. Parte
HR2470	SDS-Plus	Inserción a flecha	Broquero de inserción rápida	1	194080-7
HR2810T HR2811T HR2654T	Estándar 1/2"	SDS-Plus	Juego para cambio rápido	1	194079-2

Broqueros cierre rápido



Usar en	Diámetro boca	Diámetro rosca	Detalle	Empaque piezas	No. Parte
BDF330D	3/8"	3/8"	Cierre rápido	1	766007-3
6260D	3/8"	3/8"	Cierre rápido	1	763185-0
6410	3/8"	3/8"	Cierre rápido	1	192016-0
6226DW	3/8"	3/8"	Cierre rápido	1	763180-0
BDA341, BDA351	3/8"	1/2"	Cierre rápido	1	766005-7
HP1351, HP1621	1/2"	1/2"	Cierre rápido	1	196193-0
BDF452, LXFD01, LXFD05, LXPH01, LXPH02, LXPH05	1/2"	1/2"	Cierre rápido	1	766027-7
6317D	1/2"	1/2"	Cierre rápido	1	193691-5
6311D	1/2"	3/8"	Cierre rápido	1	763103-8
6319D, 6339D, 6349D, 8414D, 8434D, 8444D, BDF454, BHP454	1/2"	3/8"	Cierre rápido	1	763191-5
MT064 (SSP)	3/8"	1/2"	Cierre rápido	1	763181-8

Broqueros estándar



Usar en	Diámetro boca	Diámetro rosca	Detalle	Empaque piezas	No. Parte
6501, MT650	1/4"	3/8"	Sin llave	1	763170-3
MDP303	3/8"	3/8"	Sin llave	1	766014-6
M0600G	3/8"	3/8"	Con llave	1	198912-0
MT80B	1/2"	1/2"	Sin llave	1	766023-5
HP1640	1/2"	1/2"	Con llave RÖHM	1	T-02820
	1/2"	1/2"	Cierre rápido	1	194254-0
6390D	1/2"	1/2"	Cierre rápido	1	763178-7
DS4010	1/2"	1/2"	Con llave	1	193822-6
DHP458			Cierre rápido	1	763248-2
HP1630 / HP1640	1/2"	1/2"	Estándar con llave	1	195081-8

Broqueros estándar



Usar en	Diámetro boca	Diámetro rosca	Detalle	Empaque piezas	No. Parte
DA4031	1/2"	1/2"	Con llave	1	193520-2
DA4511	1/2"	1/2"	Con llave	1	763062-6
HP1630	1/2"	1/2"	Con llave	1	763161-4
	3/8"	1/2"	Con llave	1	763174-5
DP4000	1/2"	1/2"	Con llave	1	763078-1
8422B	5/8"	1/2"	Sin llave	1	763254-7
6016	5/8"	Cónico M16	Con llave	1	763011-3

Broqueros adaptadores



Usar en	Diámetro boca	Zanco	Detalle	Empaque Piezas	No. Parte
Modelos SDS-Plus	1/2"	Broquero estándar con adaptador SDS-plus	Incluye llave	2	194041-7
Usar con broquero 1950818, T-01719, 192541-1			Adaptador con rosca para broqueros estándar 1/2"	1	D-14093
Atornilladores inalámbricos	3/8"	Zanco Hex. 1/4"	llave	1	763198-1

Llaves para broqueros



Usar en	Medida	Empaque piezas	No. Parte
Varios	1/4"	1	763442-6
DA301DW	3/8"	1	763415-9
Broquero Rhöm	1/2"	1	763441-8
Broquero Jacobs	1/2"	1	763434-5
		1	763427-2
6016	5/8"	1	763429-8
8419B	5/8"	1	763432-9
Varios	5/8"	1	763443-4

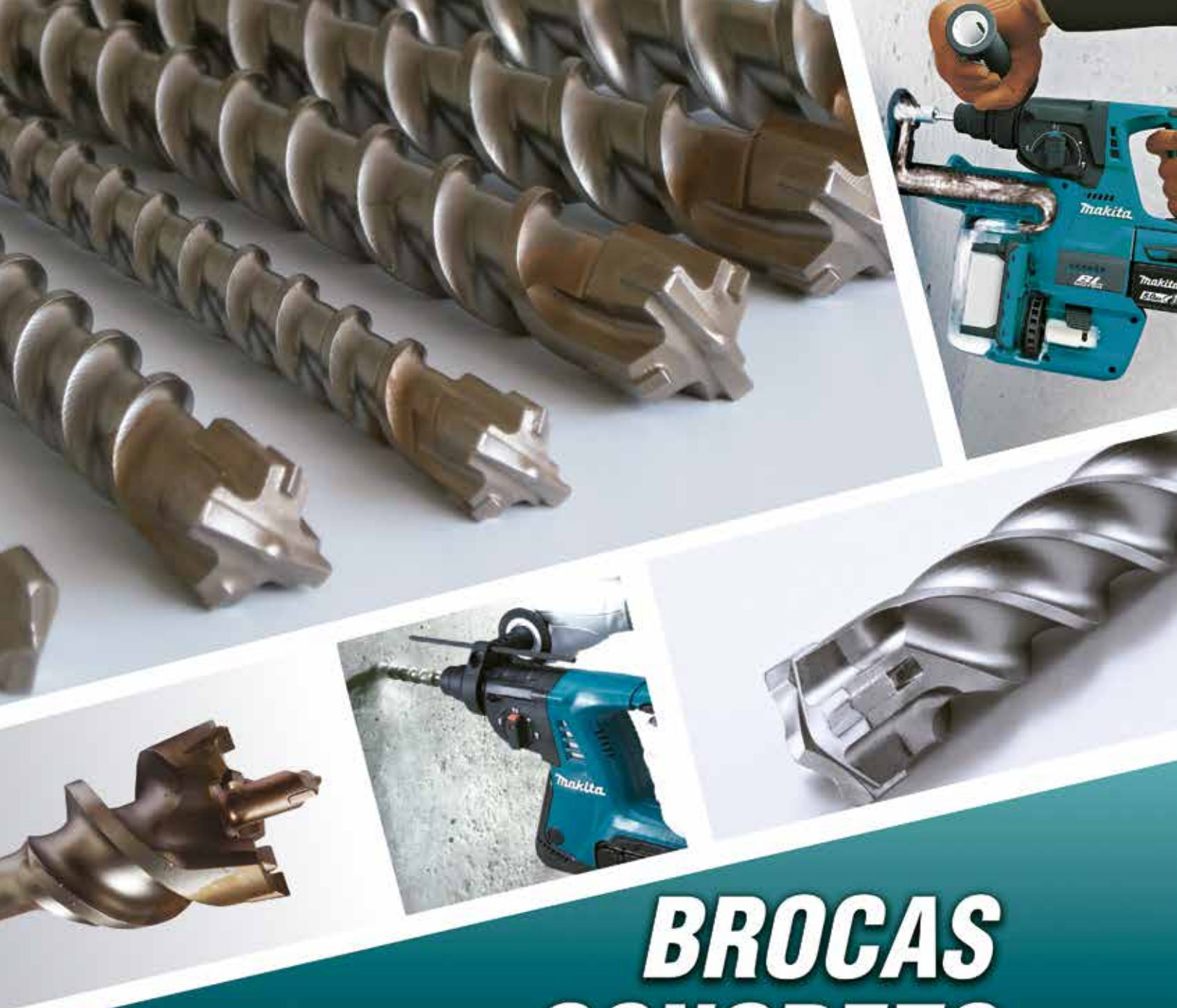

BROCAS CONCRETO



13mm Zanco Hex



28.6mm Zanco Hex
(1-1/8" Zanco Hex)



Para martillos SDS-Plus



21mm Zanco Hex



Corte rápido



19mm Zanco Hex



30mm Zanco Hex



Para martillos SDS-Max



17mm Zanco Hex



Zanco pequeño Makita



MULTIBROCAS OMNIBOHRER

Punta de carburo con percusión agudizada de mucha resistencia con cabeza reforzada. Puede perforar múltiples materiales sin necesidad de cambiar la broca.



Ideal para **puertas, estantes, marcos de ventanas, etc.**

Diámetro (mm)	Longitud total (mm)	Piezas empaque	No. parte
3/16, 1/4, 5/16", 3/8, 1/2"	3-1/2", 6", 6", 6", 6"	5	D-37029
1/8", 3/16", 1/4", 5/16", 3/8"	3, 3-1/2", 6", 6", 6"	5	D-37100

- Utilice con taladros rotativos de percusión.
- Sin el uso de percusión usar en ladrillos vitrificados, madera o ladrillo común.
- Con el uso de la percusión usar en bloque, piedra, yeso y la mayoría de los grados de concreto.



Brocas multiusos para madera, concreto, plástico, azulejo, aluminio y otros

○ Excelente △ Regular X No Recomendado

(*1) No recomendado para aluminio cuando la punta de Carburo tungsteno esta gastada. Siempre use una broca nueva cuando perfore el aluminio.

MATERIAL	CONCRETO	AZULEJO	LADRILLO	TEJA	PIEDRA CALIZA	MADERA	MADERA Y PLÁSTICO	PLÁSTICO	ALUMINIO	METAL
Figura										
Modo de operación										
Recomendaciones	○	○	○	○	○	○	○	○	○	○

Omnibohrer

(Broca multi uso)

Broca afilada de alta resistencia con cabeza reforzada para taladro percutor. Perfora diferentes materiales sin necesidad de cambiar la broca, (Ideal para perforar puertas, estantes, marcos de ventanas, etc.)

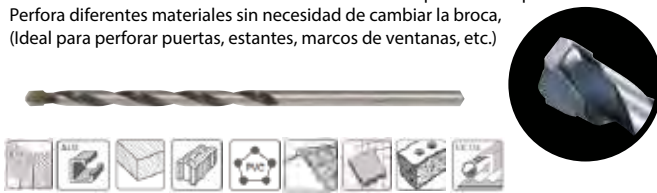

Medida: Pulgadas

Diámetro	Longitud total	Longitud trabajo	No. Parte
9/16"	6"		D-30455 NUEVO
9/16"	16"		D-30461 NUEVO
1/8"	3"	1-3/8"	D-36859
5/32"	3-1/8"	1-5/8"	D-36865
5/32"	6"	4-3/16"	D-36871
3/16"	3-1/2"	1-3/4"	D-36887
3/16"	6"	4-3/8"	D-36893
1/4"	4"	2-3/16"	D-36902
1/4"	6"	4-3/8"	D-36918
5/16"	4-3/4"	2-7/16"	D-36924
5/16"	6"	4-3/16"	D-36930
3/8"	6"	4-3/16"	D-36946
1/2"	6"	3-5/8"	D-36952

Brocas multi material

Para perforación en madera, metal, plástico, cerámica y otros materiales de mampostería

NUEVO

Punta de carburo diseñada con bordes de corte más afilados para inicios centrados



Vástago de 1/4" Hex que encaja en la mayoría de los atornilladores de impacto

Vástago redondo que encaja en la mayoría de los taladros-atornilladores de 3/8" y 1/2"

Medida: Pulgadas

Diámetro	Longitud total	Zanco	Piezas empaque	No. Parte
1/8"	3"	Cilíndrico	1	B-69004
3/16"	6"	Cilíndrico	1	B-69010
1/4"	6"	Hexágono	1	B-69026
5/16"	6"	Hexágono	1	B-69032
3/8"	6"	Hexágono	1	B-69048
1/2"	6"	Hexágono	1	B-69054
5/8"	6"	Hexágono	1	B-69060

Set de brocas multipropósito 5 piezas.

Para perforación en madera, metal, plástico, cerámica y otros materiales de mampostería

No. Parte **B-69076**



NUEVO

Diámetro	Longitud total	Longitud trabajo	Piezas
5/32"	3"	1"	5
3/16", 1/4", 3/8", 1/2"	6"	4"	

Broca para concreto

De zanco recto (estándar)

(Broca para mampostería y concreto)

Medida: Pulgadas

Diámetro	Longitud total	Longitud trabajo	No. Parte
1/8"	3"	1-3/4"	D-24309
5/32"	6"	3-9/16"	D-24315
3/16"	3-1/2"	2"	D-24321
3/16"	6"	3-9/16"	D-24337
7/32"	6"	3-9/16"	D-24343
1/4"	4"	2-3/8"	D-24359
1/4"	6"	3-9/16"	D-24365
1/4"	12"	8-7/8"	D-24371
5/16"	6"	3-9/16"	D-24387
5/16"	12"	8-7/8"	D-24393
3/8"	6"	3-9/16"	D-24402
3/8"	12"	8-7/8"	D-24418
7/16"	6"	3-9/16"	D-24424
1/2"	6"	3-3/8"	D-24430
1/2"	12"	8-7/8"	D-24446
5/8"	6"	3-3/8"	D-24452
5/8"	12"	8-7/8"	D-24468
3/4"	12"	8-7/8"	D-24480
1"	12"	8-7/8"	D-24496



Broca para concreto con inserción Hex 1/4"



Medida: Pulgadas

Diámetro	Longitud total	Longitud trabajo	Zanco tipo	Empaque Piezas	No. Parte
1/8"	3"	1-11/64"	MZ	1	D-24038
3/16"	3-11/32"	1-9/16"	MZ	1	D-24044
1/4"	4"	2-5/32"	MZ	1	D-24050

Surtido de brocas para concreto

* 5 tamaños diferentes

Medida: Pulgadas



Diámetro	Longitud total	Longitud trabajo	Piezas por empaque	No. Parte
3/16"	3-1/2"	2"	5	*D-36033
1/4", 5/16" 3/8", 1/2"	6"	3-9/16"		
1/4"	6"	3-9/16"	5	D-36027
5/32"	6"		5	D-66597
3/16"	6"		5	D-66606
5/16"	6"		5	D-71059 NUEVO
3/8"	6"		5	D-71065 NUEVO
1/2"	6"		5	D-71071 NUEVO

Surtido de brocas para concreto 20 piezas

Medida: Pulgadas



Diámetro	Longitud total	Longitud trabajo	Piezas empaque	No. Parte
1/4"	6"	3-9/16"	20	D-24365-20
3/8"	6"	3-9/16"	20	D-24402-20
1/2"	6"	3-3/8"	20	D-24430-20
5/32"	6"		20	D-66575 NUEVO
3/16"	6"		20	D-66581 NUEVO
5/16"	6"		20	D-71087 NUEVO

Brocas para vidrio

Para perforación de azulejos de cerámica, vidrio no templado, plástico, compuesto, ladrillo y mármol

NUEVO



Diámetro	Longitud total	No. Parte
1/8"	3"	B-68937
3/16"	3"	B-68943
1/4"	4"	B-68959
5/16"	4"	B68965
3/8"	4"	B-68971
1/2"	4"	B-68987

Broca para vidrio



Ver video



Medida: Pulgadas

Diámetro	Longitud total	No. Parte
1/8"	2-1/2"	D-25183
3/16"	2-1/2"	D-25199
1/4"	3"	D-25208
5/16"	3"	D-25214
3/8"	3-1/8"	D-25220
1/2"	3-1/8"	D-25236

Set de brocas para vidrio

Juego de 5 piezas

NUEVO

No. Parte **B-68993**



Medida: Pulgadas

Diámetro	Longitud total	Longitud trabajo
3/16"	4-1/2"	1-5/8"
1/4"	6-1/4"	3-5/8"
5/16"	6-1/4"	3-5/8"
3/8"	6-1/4"	3-5/8"
1/2"	6-1/4"	3-3/8"



SDS-PLUS "Pro Line"

Perforación en concreto, para uso con martillos rotativos y taladros de percusión con sistema SDS-Plus



Medida: Pulgadas

Diámetro	Longitud total	Longitud trabajo	No. Parte
5/32"	4-1/2"	1-5/8"	D-00804
5/32"	6-1/4"	3-5/8"	D-00810
3/16"	4-1/2"	1-5/8"	D-00826
3/16"	6-1/4"	3-5/8"	D-00832
3/16"	8-1/4"	5-1/2"	D-00848
7/32"	6-1/4"	3-5/8"	D-00854
1/4"	4-1/2"	1-5/8"	D-00860
1/4"	6-1/4"	3-5/8"	D-00876
1/4"	8-1/4"	5-1/2"	D-00882
1/4"	11"	8-1/16"	D-00898
5/16"	6-1/4"	3-5/8"	D-00907

SDS-PLUS "Pro Line"

Perforación en concreto, para uso con martillos rotativos y taladros de percusión con sistema SDS-Plus



Medida: Pulgadas

Diámetro	Longitud total	Longitud trabajo	No. Parte
5/16"	12"	9-1/16"	D-00913
3/8"	6-1/4"	3-5/8"	D-00929
3/8"	12-1/4"	9-1/4"	D-00935
7/16"	6-1/4"	3-5/8"	D-00941
7/16"	12-1/2"	9-1/4"	D-00957
1/2"	6-1/4"	3-3/8"	D-00963
1/2"	12-1/4"	8-7/8"	D-00979
9/16"	6-1/2"	3-3/8"	D-00985
9/16"	12-1/2"	8-7/8"	D-00991
5/8"	8"	4-1/2"	D-01002
5/8"	12"	8-5/8"	D-01018
11/16"	8"	4-5/16"	D-01024
3/4"	8"	4-5/16"	D-01030
3/4"	12"	8-7/16"	D-01046
7/8"	8"	4-5/16"	D-01052
7/8"	12"	8-7/16"	D-01068
1"	10"	6-1/2"	D-01074

SDS-PLUS "Pro line" Paquete de 25 piezas (1 diámetro)



Medida: Pulgadas

Diámetro	Longitud total	Longitud trabajo	No. Parte
5/32"	4-1/2"	1-5/8"	D-00804-25
5/32"	6-1/4"	3-5/8"	D-00810-25
3/16"	4-1/2"	1-5/8"	D-00826-25
3/16"	6-1/4"	3-5/8"	D-00832-25
3/16"	8-1/4"	5-1/2"	D-00848-25
7/32"	6-1/4"	3-5/8"	D-00854-25
1/4"	4-1/2"	1-5/8"	D-00860-25
1/4"	6-1/4"	3-5/8"	D-00876-25
1/4"	8-1/4"	5-1/2"	D-00882-25
1/4"	11"	8-1/16"	D-00898-25
5/16"	6-1/4"	3-5/8"	D-00907-25

SDS-PLUS "Pro line" paquete de 25 piezas (1 diámetro)



Medida: Pulgadas

Diámetro	Longitud total	Longitud trabajo	No. Parte
5/16"	12"	9-1/16"	D-00913-25
3/8"	6-1/4"	3-5/8"	D-00929-25
3/8"	12-1/4"	9-1/4"	D-00935-25
7/16"	6-1/4"	3-5/8"	D-00941-25
7/16"	12-1/4"	9-1/4"	D-00957-25
1/2"	6-1/4"	3-3/8"	D-00963-25
1/2"	12-1/4"	8-7/8"	D-00979-25
9/16"	6-1/4"	3-3/8"	D-00985-25
9/16"	12-1/4"	8-7/8"	D-00991-25
5/8"	8"	4-1/2"	D-01002-25
5/8"	12"	8-5/8"	D-01018-25
11/16"	8"	4-5/16"	D-01024-25
3/4"	8"	4-5/16"	D-01030-25
3/4"	12"	8-7/16"	D-01046-25
7/8"	8"	4-5/16"	D-01052-25
7/8"	12"	8-7/16"	D-01068-25
1"	10"	6-1/2"	D-01074-25

Set de brocas SDS-PLUS 5 piezas.

Juego de 5 piezas

No. Parte **D-07973**

Medida Pulgadas

Diámetro	Longitud total	Longitud trabajo
3/16"	4-1/2"	1-5/8"
1/4"	6-1/4"	3-5/8"
5/16"	6-1/4"	3-5/8"
3/8"	6-1/4"	3-5/8"
1/2"	6-1/4"	3-3/8"



Set de brocas y cinces SDS-PLUS

Juego de 10 piezas

No. Parte **D-45820**

Diámetro	Longitud total	Longitud trabajo
3/16"	6-1/4"	3-5/8"
7/32"	6-1/4"	3-5/8"
1/4"	6-1/4"	3-5/8"
5/16"	6-1/4"	3-5/8"
3/8"	6-1/4"	3-5/8"
7/16"	6-1/4"	3-5/8"
1/2"	6-1/4"	3-3/8"
9/16"	6-1/4"	3-3/8"
Cinzel de 160		
Cinzel de 20x140		



Medida: Pulgadas

El equipo estándar (accesorios), las especificaciones y las fotografías pueden variar. Los accesorios pueden no estar incluidos desde origen con las herramientas, aunque se indiquen en este catálogo.

Brocas y cinceles SDS-PLUS

Juego de 17 piezas
Estuche textil



Empaque Piezas	Diámetro	Largo	Zanco	No. Parte	
17 piezas	3/16"	4-1/2"	SDS-Plus	D-53637	
	7/32"	6-1/4"	SDS-Plus		
	1/4"	4-1/2"	SDS-Plus		
	1/4"	6-1/4"	SDS-Plus		
	1/4"	8-1/4"	SDS-Plus		
	5/16"	6 1/4"	SDS-Plus		
	5/16"	10"	SDS-Plus		
	3/8"	6-1/4"	SDS-Plus		
	3/8"	10"	SDS-Plus		
	1/2"	6-1/4"	SDS-Plus		
	1/2"	10"	SDS-Plus		
	9/16"	6-1/2"	SDS-Plus		
	Cinzel punta 140				SDS-Plus
	Cinzel punta 250				SDS-Plus
	Cinzel plano 20x250				SDS-Plus
	Cinzel plano 20x140				SDS-Plus
	Cinzel pala 40x250				SDS-Plus

Brocas y cinceles SDS-PLUS

SDS-Plus con punta de carburo de tungsteno
Maletín
Juego de 13 piezas



Medida: Pulgadas

Empaque Piezas	Diámetro	Longitud total	Longitud trabajo	No. Parte	
13 piezas	5/32"	4-1/2"	1-5/8"	D-31734	
	3/16"	4-1/2"	1-5/8"		
	3/16"	6-1/4"	3-5/8"		
	7/32"	6-1/4"	3-5/8"		
	1/4"	4-1/2"	1-5/8"		
	1/4"	6-1/4"	3-5/8"		
	5/16"	6-1/4"	3-5/8"		
	3/8"	6-1/4"	3-5/8"		
	1/2"	6-1/4"	3-3/8"		
	9/16"	6-1/4"	3-3/8"		
	5/8"	8"	4-1/2"		
	cinzel punta 250mm				
	Cinzel plano 10x250mm				

Maletín de cinceles, brocas y broquero SDS-PLUS

Juego de 14 piezas

NUEVO



Medida: Pulgadas

	Diámetro	Longitud total	Longitud trabajo	No. Parte	
Brocas SDS-Plus	5/32"	4-1/2"	1-5/8"	D-71205	
	3/16"	4-1/2"	1-5/8"		
	3/16"	6-1/4"	3-5/8"		
	7/32"	6-1/4"	3-5/8"		
	1/4"	4-1/2"	1-5/8"		
	1/4"	6-1/4"	3-5/8"		
	5/16"	6-1/4"	3-5/8"		
	3/8"	6-1/4"	3-5/8"		
	1/2"	6-1/4"	3-3/8"		
	9/16"	6-1/4"	3-3/8"		
	5/8"	8"	4-1/2"		
	Cinzel punta SDS-Plus 10"				
	Cinzel plano SDS-Plus 3/4"x10"				
	Broquero SDS-Plus 13mm y llave				



Brocas SDS-PLUS Centering tip

Para martillos con entrada SDS-PLUS



Nuevo empaque retráctil y clip, que protege la broca del polvo y evita que se oxide.



Nueva punta centradora que facilita la perforación

Punta fabricada para alto rendimiento

Perforaciones 10% más rápidas que las brocas convencionales SDS PLUS



Medida: Pulgadas

Alto desempeño, para uso profesional



Diámetro (In)	Longitud total	Empaque Piezas	No. Parte
5/32"	6-1/4"	1	B-61662
3/16"	4-1/2"	1	B-61678
3/16"	6-1/4"	1	B-61684
3/16"	8-1/4"	1	B-61690
3/16"	12"	1	B-61709
7/32"	6-1/4"	1	B-61715
1/4"	4-1/2"	1	B-61721
1/4"	6-1/4"	1	B-61737
1/4"	8-1/4"	1	B-61743
1/4"	11"	1	B-61759
5/16"	6-1/4"	1	B-61765
5/16"	12"	1	B-61771
3/8"	6-1/4"	1	B-61787
3/8"	12-1/4"	1	B-61793
3/8"	18"	1	B-61802
7/16"	12-1/2"	1	B-61818
1/2"	6-1/4"	1	B-61824
1/2"	12-1/4"	1	B-61830
9/16"	6-1/2"	1	B-61846
9/16"	12-1/2"	1	B-61852
5/8"	8"	1	B-61868
5/8"	12"	1	B-61874
3/4"	8"	1	B-61880
3/4"	12"	1	B-61896
7/8"	12"	1	B-61905
7/8"	18"	1	B-61911
1"	10"	1	B-61927
1"	18"	1	B-61933

SDS-PLUS "V PLUS"

Diseñada para reducir vibración

Perforación en concreto para uso con martillos rotativos y taladros de precisión con sistema SDS-Plus



3 puntos de contacto en el cabezal de broca incrementando la velocidad y potencia del astillado

NUEVO



Las brocas de 2 filos SDS Plus y SDS MAX de Makita están diseñadas para ser una opción más rápida cuando la resistencia de la varilla no es un problema

La punta de centrado con carburo de tungsteno presenta un diseño más agresivo para un rápido y confiable inicio del agujero



Medida: Pulgadas

Diámetro	Longitud total	Longitud trabajo	Piezas empaque	No. Parte
5/32"	4"	6"	1	B-60551
3/16"	2"	4"	1	B-60567
3/16"	4"	6"	1	B-60573
3/16"	10"	12"	1	B-60589
7/32"	4"	6"	1	B-60595
1/4"	2"	4"	1	B-60604
1/4"	4"	6"	1	B-60610
1/4"	10"	12"	1	B-60626
5/16"	4"	6"	1	B-60632
5/16"	10"	12"	1	B-60648
3/8"	4"	6"	1	B-60654
3/8"	10"	12"	1	B-60660
3/8"	16"	18"	1	B-60676
3/8"	22"	24"	1	B-60682
7/16"	10"	12"	1	B-60698
1/2"	4"	6"	1	B-60707
1/2"	10"	12"	1	B-60713
1/2"	22"	24"	1	B-60729
9/16"	4"	6"	1	B-60735
9/16"	10"	12"	1	B-60741
5/8"	6"	8"	1	B-60757
5/8"	10"	12"	1	B-60763
5/8"	22"	24"	1	B-60779
3/4"	6"	8"	1	B-60785
3/4"	10"	12"	1	B-60791
3/4"	22"	24"	1	B-60800
7/8"	10"	12"	1	B-60816
7/8"	16"	18"	1	B-60822
1"	8"	10"	1	B-60838
1"	16"	18"	1	B-60844

Brocas SDS-Max línea industrial

2 filos

Perforación en concreto para uso con martillos rotativos con sistema SDS-Max

NUEVO



Medida: Pulgadas

Diámetro	Longitud total	Longitud trabajo	Filos	Empaque Piezas	No. Parte
3/8"	8"	13"	2	1	B-66276
1/2"	8"	13"	2	1	B-61307
1/2"	16"	21"	2	1	B-61313
9/16"	8"	13"	2	1	B-61329
9/16"	16"	21"	2	1	B-61335

Brocas SDS-Max línea industrial



La resistencia Flex ayuda a reducir los efectos negativos que ejerce la presión extrema sobre la broca; que es usualmente el factor más dañino



Las brocas de 6 filos de corte SDS MAX están diseñadas para perforación de concreto armado y agujeros más exactos

NUEVO

Medida: Pulgadas

Diámetro	Longitud trabajo	Longitud total	Filos	Empaque Piezas	No. Parte
5/8"	8"	13"	6	1	B-61341
5/8"	16"	21"	6	1	B-61357
5/8"	31"	36"	6	1	B-61363
11/16"	16"	21"	6	1	B-61379
3/4"	8"	13"	6	1	B-61385
3/4"	16"	21"	6	1	B-61391
3/4"	31"	36"	6	1	B-61400
13/16"	16"	21"	6	1	B-61416
7/8"	8"	13"	6	1	B-61422
7/8"	16"	21"	6	1	B-61438
7/8"	31"	36"	6	1	B-61444
1"	8"	13"	6	1	B-61450
1"	16"	21"	6	1	B-61466
1"	31"	36"	6	1	B-61472
1-1/8"	8"	13"	6	1	B-61488
1-1/8"	16"	21"	6	1	B-61494
1-1/8"	31"	36"	6	1	B-61503
1-1/4"	8"	13"	6	1	B-61519
1-1/4"	16"	21"	6	1	B-61525
1-1/4"	31"	36"	6	1	B-61531
1-3/8"	16"	21"	6	1	B-61547
1-3/8"	31"	36"	6	1	B-61553
1-1/2"	16"	21"	6	1	B-61569
1-1/2"	31"	36"	6	1	B-61575
1-3/4"	16"	21"	6	1	B-66282

Brocas SDS-Plus con extractor de polvo

Perforación en concreto para uso con martillos rotativos con sistema SDS-Max

NUEVO

Ideal para perforación de hormigón armado, hormigón, piedra, mampostería, ladrillo, piedra caliza



Mango de conexión a sistema de aspiración
- Mantiene el área de trabajo limpia de polvo
- Aumenta la vida útil de la broca



E-07185

Adaptador de plástico para brocas, se adapta a la mayoría de las aspiradoras

Medida: Pulgadas

Diámetro	Longitud total	Empaque Piezas	No. Parte
1/2"	10-7/16" x 16"	1	E-07141
9/16"	10-7/16" x 16"	1	E-07157
5/8"	10-7/16" x 16"	1	E-07163
3/4"	10-7/16" x 16"	1	E-07179
Adaptador de plástico para brocas SDS- PLUS			1 E-07185

Brocas SDS-Max con extracción de polvo

Perforación en concreto para uso con martillos rotativos con sistema SDS-Max

NUEVO

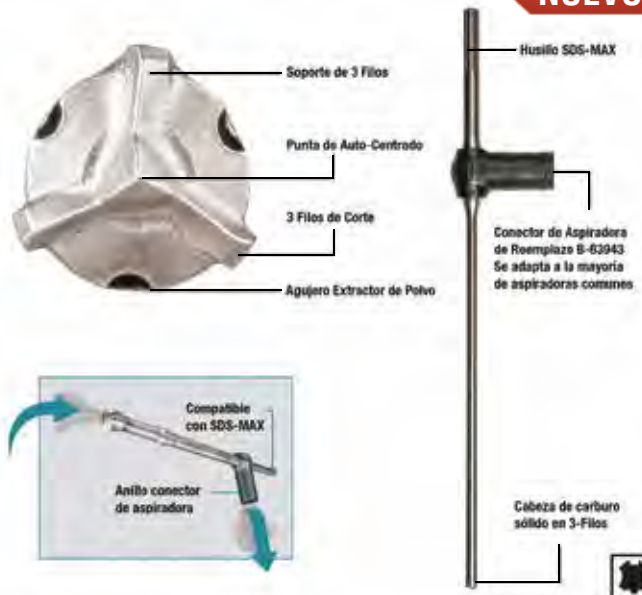

Soporte de 3 Filos

Punta de Auto-Centrado

3 Filos de Corte

Agujero Extractor de Polvo

Husillo SDS-MAX

Conector de Aspiradora de Reemplazo B-63943. Se adapta a la mayoría de aspiradoras comunes.

Compatible con SDS-MAX

Anillo conector de aspiradora

Cabeza de carburo sólido en 3-Filos

Medida: Pulgadas

Diámetro	Longitud total	Empaque Piezas	No. Parte
1/2"	15-3/4" x 24"	1	B-63828
9/16"	15-3/4" x 24"	1	B-63834
5/8"	15-3/4" x 24"	1	B-63840
3/4"	15-3/4" x 24"	1	B-63862
7/8"	15-3/4" x 24"	1	B-63884
1"	15-3/4" x 24"	1	B-63890
1-1/8"	15-3/4" x 24"	1	B-63909
1-3/8"	15-3/4" x 24"	1	B-63937
Adaptador de plástico para brocas SDS- MAX			1 B-63943

Brocas SDS-MAX (Minería)

Diseñadas para perforación en roca y piedra natural para la exploración y explotación de los siguientes metales, entre otros:

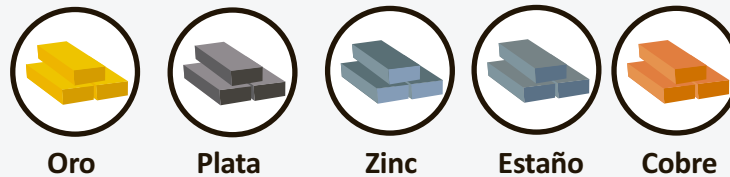

RESISTENTE Y CONFIABLE

Especialmente en piedra natural muestra su alta resistencia. La geometría robusta de la pastilla de carburo de tungsteno esta diseñada para trabajar bajo condiciones extremas. Estas brocas tienen la posibilidad de afilar las pastillas permitiendo una vida más larga ya que pueden perforar 25% o más que las brocas de martillo SDS-MAX estándar.



PASTILLAS LATERALES REFORZADAS

- Las pastillas laterales de carburo de tungsteno apoyan la actividad de la pastilla central.
- Debido al refuerzo que cubre las pastillas laterales, estas son más resistentes.
- Las entradas amplias de los espirales facilitan la evacuación de la roca demolida.



GEOMETRÍA DE LA ESPIRAL

- La espalda expandida de estas brocas las hacen más resistentes, así mismo garantiza la evacuación rápida de polvo de la perforación desde la cabeza a través del espiral.



REFORZAMIENTO DE LA GEOMETRÍA DE LA ESPIRAL

- Debido a este reforzamiento, la broca puede soportar más fuerzas de flexión; lo cual es un desafío en perforaciones bajo condiciones extremas en roca dura.

GEOMETRÍA ROBUSTA DE LA PASTILLA DE CARBURO DE TUNGSTENO

- La pastilla principal de esta broca tiene una geometría muy robusta. Debido a esta característica, la broca es muy resistente y eficiente inclusive en las condiciones más extremas.

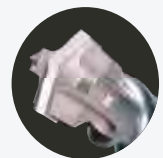

Medidas: pulgadas

Diámetro	Longitud	Longitud trabajo	Tipo	Piezas	No. Parte
1-1/8"	53"	47"	Minería	1	B-18041
1-1/4"	23"	18"	Minería	1	B-14613
1-1/4"	37"	32"	Minería	1	B-15045
1-1/4"	52"	47"	Minería	1	B-18057
1-3/16"	28"	23"	Minería	1	B-05642

Brocas para minería SDS-MAX



NUEVO

PLACA DE CARBURO EN MONO BLOCK

- Con punta centradora de 135°
- 3 filos de corte
- Hélice cuadrada reducida

Diámetro	Longitud trabajo	Longitud total	Tipo	Piezas	No. Parte
1-1/8"	8"	13"	Minería	1	B-05315
1-1/4"	8"	13"	Minería	1	B-05337
1-1/8"	16"	21"	Minería	1	B-05474
1-1/4"	16"	21"	Minería	1	B-05496
1-1/8"	22"	27"	Minería	1	B-05636
1-1/4"	22"	27"	Minería	1	B-05658
1-1/8"	31"	36"	Minería	1	B-05767

SDS-PLUS "4 PLUS"

Perforación en concreto para uso con martillos rotativos y taladros de precisión con sistema SDS-Plus

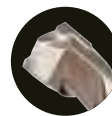

Medida: Pulgadas

Diámetro	Longitud total	Piezas empaque	No. Parte
5/32"	6 1/4"	1	711227-A
3/16"	6 1/4"	1	711229-A
3/16"	10"	1	711231-A
7/32"	6 1/4"	1	711234-A
1/4"	4 1/2"	1	711235-A
1/2"	12 1/4"	1	711249-A
9/16"	6 1/2"	1	711252-A
5/8"	8"	1	711255-A

El equipo estándar (accesorios), las especificaciones y las fotografías pueden variar. Los accesorios pueden no estar incluidos desde origen con las herramientas, aunque se indiquen en este catálogo.

Brocas estriadas (Splines) 6 filos

Especiales e ideales para un amplio rango de aplicaciones de perforación rápida en concreto y concreto armado

Para uso con martillos rotativos y rotomartillos que aceptan brocas estriadas

NUEVO

Brocas diseñadas para crear agujeros más redondos, proporcionando un ajuste de anclaje más eficiente

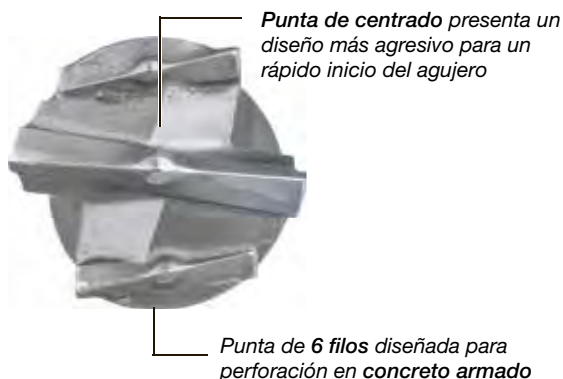

Reduce la vibración



Diámetro (mm)	Longitud total	Filos	Empaque Piezas	No. Parte
5/8" x 10"	16"	6	1	B-63993
5/8" x 18"	24"	6	1	B-64004
3/4" x 6-1/2"	12"	6	1	B-64010
3/4" x 16"	21"	6	1	B-64026
3/4" x 24"	29"	6	1	B-64032
3/4" x 31"	36"	6	1	B-64048
7/8" x 10"	16"	6	1	B-64054
7/8" x 18"	24"	6	1	B-64060
1" x 10"	16"	6	1	B-64076
1" x 16"	21"	6	1	B-64082
1-1/8" x 10"	16"	6	1	B-64098
1-1/8" x 16"	21"	6	1	B-64107
1-1/4" x 10"	16"	6	1	B-64113
1-1/4" x 18"	24"	6	1	B-64129
1-3/8" x 10"	16"	6	1	B-64135
1-3/8" x 18"	24"	6	1	B-64141
1-1/2" x 18"	24"	6	1	B-64157

Brocas SDS-Max línea estándar

Perforación en concreto para uso con martillos rotativos con sistema SDS-Max



Diámetro (mm)	Longitud total	Longitud trabajo	Empaque Piezas	No. Parte
1/2"	13"	8"	1	D-36538
1/2"	21"	16"	1	D-36544
9/16"	21"	16"	1	D-36550
5/8"	13"	8"	1	D-36566
5/8"	21"	16"	1	D-36572
3/4"	13"	8"	1	D-36588
3/4"	21"	16"	1	D-36594
27/32"	21"	16"	1	D-36603
7/8"	13"	8"	1	D-36619
7/8"	21"	16"	1	D-36625
1"	13"	8"	1	D-36631
1"	21"	16"	1	D-36647
1 1/8"	15"	10"	1	D-36653
1 1/8"	22"	18"	1	D-36669
1 1/4"	15"	10"	1	D-36675
1 1/4"	22"	18"	1	D-36681
1 3/8"	22"	18"	1	D-36697
1 1/2"	22"	18"	1	D-36706

Brocas SDS-Max core cutter

Perforación en concreto para diámetros mayores a 1-1/2" Sistema SDS-Max core cutter



Diámetro (mm)	Longitud total	Empaque piezas	No. Parte
1 3/4"	39"	1	P-21917
2 1/8"	39"	1	P-21939
2 1/2"	22"	1	B-63563 / B-66307
3 1/8"	22"	1	B-63579
3 1/8"	29"	1	P-21973

Brocas SDS-Plus **3 FILOS**

NUEVO



Los **3 filos de corte de 135°** ofrecen perforaciones más eficientes sin agrietar las orillas

Los **3 filos de corte** facilitan atravesar la varilla manteniendo la flauta siempre recta

Mayor eliminación de material

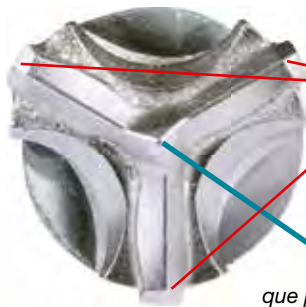

3 filos de corte diseñados para perforar concreto armado y más

Punta autocentrante con diseño agresivo que permite un arranque rápido

DURABILIDAD

Acero y carburo de primera calidad

- Diseñado para perforar concreto armado
- Pastillas de carburo de alta durabilidad
- Resistente a la flexión
- Resistente al sobrecalentamiento
- Baja vibración
- Ideal para concreto, concreto armado, piedra y granito

PRECISIÓN

- Perforaciones más precisas debido a los 3 soportes de 120° entre cada borde, importante para la instalación de anclas
- La punta de carburo de tungsteno autocentrante conduce la broca en línea recta para un inicio confiable

VELOCIDAD

Flauta diseñada para eliminación de materiales más rápido



Brocas SDS-Plus core cutter

Perforaciones de 1-3/16" a 4" sobre ladrillo en un solo paso

Ideal para perforar en ladrillo, piedra caliza y mortero

NUEVO



Diámetro (mm)	Longitud usable	Filos	Empaque Piezas	No. Parte
3/16" x 4"	2"	3	1	B-60975
3/16" x 8"	6"	3	1	B-60997
3/16" x 12"	10"	3	1	B-61008
1/4" x 4"	2"	3	1	B-61014
1/4" x 6"	4"	3	1	B-61020
1/4" x 8"	6"	3	1	B-61036
1/4" x 12"	10"	3	1	B-61042
5/16" x 6"	4"	3	1	B-61058
5/16" x 12"	10"	3	1	B-61064
3/8" x 6"	4"	3	1	B-61070
3/8" x 12"	10"	3	1	B-61086
3/8" x 18"	16"	3	1	B-61092
1/2" x 6"	4"	3	1	B-61101
1/2" x 12"	10"	3	1	B-61117
1/2" x 18"	16"	3	1	B-61123
5/8" x 10"	8"	3	1	B-61139
5/8" x 18"	16"	3	1	B-61145
3/4" x 10"	8"	3	1	B-61151
3/4" x 18"	16"	3	1	B-61167

Descripción	Diámetro	Longitud de trabajo	Piezas por Empaque	No. Parte
Broca SDS plus core cutter	30mm (1-3/16")	50	1	D-73891
Broca SDS plus core cutter	35mm (1-3/8")	50	1	D-73900
Broca SDS plus core cutter	40mm (1-9/16")	50	1	D-73916
Broca SDS plus core cutter	50mm (2")	50	1	D-73922
Broca SDS plus core cutter	68mm (2-11/16")	50	1	D-73938
Broca SDS plus core cutter	82mm (3-1/4")	50	1	D-73944
Broca SDS plus core cutter	90mm (3-1/2")	50	1	D-73950
Broca SDS plus core cutter	100mm (4")	50	1	D-73966
Broca piloto para core cutter	8x110mm	-	1	D-73972
Adaptador para broca core cutter	110mm	-	1	D-73988
Adaptador para broca core cutter	200mm	-	1	D-73994
Adaptador para broca core cutter	350mm	-	1	D-74005
Set core cutter	68mm	-	1	D-74011
Set core cutter	82mm	-	1	D-74027

El equipo estándar (accesorios), las especificaciones y las fotografías pueden variar. Los accesorios pueden no estar incluidos desde origen con las herramientas, aunque se indiquen en este catálogo.



Brocas estriadas (Spline) 2 filos

Especiales e ideales para un amplio rango de aplicaciones de perforación en concreto



NUEVO

Para uso con martillos rotativos y rotomartillos que aceptan brocas estriadas

Diseño especial de flauta
Remueve el polvo más rápido que otras brocas estándar

Punta de carburo de autocentrado diseñada para utilizar en concreto

La punta de centrado presenta un diseño más agresivo para un rápido inicio del agujero



Diámetro (mm)	Longitud total	Filos	Empaque Piezas	No. Parte
3/8" x 6-1/2"	12"	2	1	B-63959
1/2" x 8"	13"	2	1	B-63965
1/2" x 18"	23"	2	1	B-63971
9/16" x 8"	13"	2	1	B-63987

Brocas estriadas (Spline) 2 filos

Perforación en concreto para uso con martillos rotativos con sistema Spline



*Dos Filos

Diámetro (mm)	Longitud total	Empaque Piezas	No. Parte
1/2"	29"	1	711195-A
22mm	525mm	1	791134-7
20mm	525mm	1	791024-4

Brocas estriadas (Spline) 4 filos

Perforación en concreto con martillos rotativos con Sistema Spline

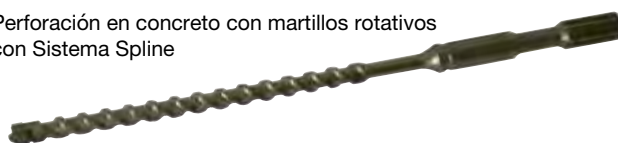

Diámetro (mm)	Longitud total	Empaque piezas	No. Parte
5/8"	10"	1	711430-A
5/8"	16"	1	711431-A
5/8"	22"	1	711432-A
5/8"	29"	1	711433-A
5/8"	36"	1	711434-A
3/4"	10"	1	711435-A
3/4"	22"	1	711437-A
3/4"	29"	1	711438-A
1"	36"	1	711445-A
1 1/8"	16"	1	711446-A
1 1/4"	36"	1	711451-A
1 3/8"	22"	1	711453-A

Brocasiera de carburo

Para concreto no reforzado, ladrillo, block y materiales de construcción.



Diámetro (mm)	Longitud total	Empaque piezas	No. Parte
2"	22"	1	752104-A
2-1/2"	22"	1	752106-A
5"	12"	1	752113-A
1-3/4"	repuesto de plato guía	1	752140-A
2-1/2"	repuesto de plato guía	1	752142-A
3"	repuesto de plato guía	1	752143-A
1-3/4"	s/a	1	752124-A

Set para remover brocas

Use con una llave de impacto para remover broca de SDS Max que se trabe con una varilla en el concreto



Destino	No. Parte
Herramienta de utilidad para desatascar brocas, usar con llave de impacto	195871-9

Brocas SDS-PLUS



Marca de estabilidad

Marca de desgaste que sirve como indicador de la estabilidad de los agujeros. Al desaparecer la marca significa que la broca ha alcanzado su vida útil.

TCT solido grande

Punta de carburo con simetría 4x90°, para corte masivo y simétrico que previene que se atasque. Su geometría ha sido desarrollada para un máximo impacto y fuerza de torsión, así como una vida útil prolongada.

Innovada geometría de la flauta

En la nueva geometría **helicoidal de 4 espirales**, se alternan hélices estrechas y anchas. **Las estrechas** aceleran el avance de la broca para menos fricción y **las anchas** soportan estructuralmente el martillo reduciendo el desgaste.

El polvo se elimina más rápidamente y garantiza perforaciones de baja vibración y un alto grado de seguridad.

*Perforación en concreto para uso con martillos rotativos SDS-Plus.

Diámetro (mm)	Longitud total	Empaque Piezas	No. Parte
5/32"	4 1/2"	1	B-59330
5/32"	6 1/2"	1	B-59346
3/16"	4 1/2"	1	B-59352
3/16"	6 1/2"	1	B-59368
3/16"	8 1/2"	1	B-59374
3/16"	10 1/2"	1	B-59380
3/16"	12 1/2"	1	B-59396
1/4"	4 1/2"	1	B-59405
1/4"	6 1/2"	1	B-59411
1/4"	8 1/2"	1	B-59427
1/4"	10 1/2"	1	B-59433
1/4"	12 1/2"	1	B-59449
5/16"	6 1/2"	1	B-59455
5/16"	12 1/4"	1	B-59461
5/16"	18"	1	B-59477
3/8"	6 1/4"	1	B-59483
3/8"	12 1/4"	1	B-59499
3/8"	18"	1	B-59508
7/16"	6 1/4"	1	B-59514
7/16"	12 1/4"	1	B-59520
7/16"	18"	1	B-59536
1/2"	6 1/4"	1	B-59542
1/2"	12 1/4"	1	B-59558

Diámetro (mm)	Longitud total	Empaque Piezas	No. Parte
1/2"	18"	1	B-59564
9/16"	6 1/4"	1	B-59570
9/16"	12 1/4"	1	B-59586
9/16"	18"	1	B-59592
5/8"	8 1/4"	1	B-59601
5/8"	10 1/4"	1	B-59617
5/8"	12 1/4"	1	B-59623
5/8"	18"	1	B-59639
3/4"	8"	1	B-59645
3/4"	10"	1	B-59651
3/4"	12"	1	B-59667
3/4"	18"	1	B-59673
7/8"	8"	1	B-59689
7/8"	10"	1	B-59695
7/8"	12"	1	B-59704
7/8"	18"	1	B-59710
1"	10"	1	B-59726
1"	12"	1	B-59732
1"	18"	1	B-59748
1 1/8"	10"	1	B-59754
1 1/8"	18"	1	B-59760
1 1/4"	18"	1	B-59776
3/16" 1/4" 5/16"	6 1/2"	5 (Kit de brocas)	B-59829
3/8" 1/2"	6 1/4"		



Resuelve problemas

Ideal para la perforación de concreto armado. **50% superior** en el trabajo, más cantidad de perforaciones.

Perforación más precisa

Simetría 4x90°, para perforaciones totalmente circulares y precisas para fijación y anclaje.

















*Brocas SDS-Plus 4 filos.

*Perforación en concreto para uso con martillos rotativos y taladros de percusión con sistema SDS-Plus.

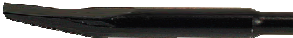
Diámetro (mm)	Longitud total	Empaque Piezas	No. Parte
3/16"	8 1/4"	1	B-17778
5/16"	12 1/4"	1	B-17865
7/16"	6 1/4"	1	B-17918
1/2"	12 1/4"	1	B-17952
9/16"	12 1/4"	1	B-17980

Tipos de cinceles

									
	Aplicación	Para martillos SDS-PLUS	Para martillos SDS-MAX	17mm Hex 11/16"	19mm Hex 3/4"	21mm Hex 13/16"	28.6mm Hex 1-1/8"	30mm Hex 1-3/16"	Makita pequeño
 <p>Cinzel punta autoafilable</p>	Demolición en mampostería y concreto. Inicio de perforación en concreto No necesita usar tiempo para el reafilado		○						
 <p>Cinzel punta</p>	Demolición en mampostería y concreto.	○	○	○	○		○	○	○
 <p>Cinzel plano</p>	Ajuste de trabajo en mampostería y concreto. Ruptura, demolición, bordes y canalado en mampostería y concreto.	○	○	○	○		○	○	
 <p>Cinzel ranurado</p>	Corte de canales en concreto.								
 <p>Cinzel pala</p>	Remover residuos de concreto	○	○	○	○		○	○	
 <p>Cortador de asfalto</p>	Cavado de arcilla, grava dura, grava apisonada y suciedad		○	○	○			○	
 <p>Pisón</p>	Apisonamiento de asfalto y compactado de grava, suelo y suciedad				○		○	○	
 <p>Martelina</p>	Desbaste de concreto y asfalto. (martelinar)		○						



CINCEL PUNTA AUTOAFILABLE

La tecnología de nuestros aceros aseguran un afilado permanente y eficiencia en su vida útil.

Con un alto grado de extracción de material y no requiere re-afilado, estos nuevos aceros reducen el tiempo de trabajo y el costo de manera significativa.

Set de cinces autoafilables zanco SDS PLUS y SDS MAX

NUEVO

Beneficios de los cinces autoafilables

- No necesita re-afilado
- No se interrumpe el trabajo por re-afilado
- Sin costo de servicio



Tiempo de trabajo

Permite trabajo continuo de hasta 100 horas en condiciones de trabajo óptimas

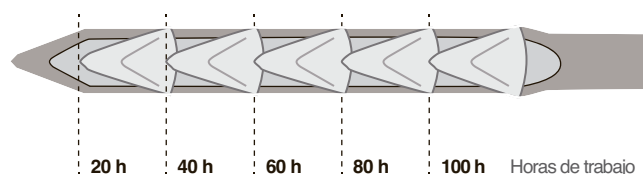

Innovación

La nueva punta tocada de los cinces de punta reducen los atascos gracias a un espacio que dejan alrededor de la punta.



Contenido	Medida (mm)	Piezas por empaque	No. parte
Cinzel de Punta SDS PLUS (2pzs)	250mm	5	E-13188
Cinzel Plano SDS PLUS (2pzs)	20x250mm		
Cinzel Pala SDS PLUS (1pz)	40x250mm		
Cinzel de Punta SDS MAX (2pzs)	250mm	5	E-13194
Cinzel Plano SDS MAX (2pzs)	20x250mm		
Cinzel Pala SDS MAX (1pz)	40x250mm		



Longitud (mm)	Tipo	No. parte
400 mm	SDS MAX Auto afilable	B-10621
400 mm	Zanco HEX 1-1/8" Auto afilable	B-10372



D-62424
Punta

D-62446
Pala

D-62430
Plano

CINCELES SDS PLUS

Nuevo empaque retráctil que **protege el cincel y evita que se oxide**



Cincel de punta
Para demoler concreto



Cincel plano
Para quebrar cantera, acanalar y remover grandes fragmentos de concreto



Cincel pala
Para remover incrustaciones y salpicaduras de concreto solidificado

..... **Con Clip**

Ideales para trabajos de construcción, albañilería o decoradores de interiores que utilicen **martillos SDS PLUS**

Usar en	Descripción	Longitud (mm)	Piezas por empaque	No. parte
martillos SDS PLUS	Cincel de punta	250 mm	1	D-62424
martillos SDS PLUS	Cincel plano	20 x 250mm	1	D-62430
martillos SDS PLUS	Cincel pala	50 x 215mm	1	D-62446

Cinceles para martillos rotativos y demolidores SDS-PLUS



Para modelo:

BHR200, BHR202, BHR241, BHR242, BHR243, BHR262/T, HR262D/TD, HR2451, HR2452, HR2432, HR2455, HR2470F, HR2470, HR2470FT, HR2470T, HR2811F, HR2810, HR2811FT, HR2810T, HR3200C, HR3210C, HR3210FCT

Cinzel de punta

(Para demoler concreto)



Longitud (mm)	Tipo	No. Parte
160	-	D-08034
250	-	D-08713
400	-	D-19015
250	-	D-62424

Cinzel plano

(Para quebrar, cantera, acanalar y remover grandes fragmentos de concreto)



Longitud (mm)	Tipo	No. Parte
20 x 250	-	D-08729
20 x 400	-	D-19021
20 x 250	-	D-62430

Cinzel pala

(Cinzel ancho para remover incrustaciones y salpicaduras de concreto solidificado)



Longitud (mm)	Tipo	No. Parte
40 x 250mm	-	D-08735
80 x 250mm	-	D-61014
50 x 215mm	-	D-62446

Cinceles para demolición



Para modelo:

HR3540C, HR3541FC, HR4001C, HR4002, HR4010C, HR4011C, HR4501C, HR4510C, HR4511C, HR5201C, HR5210C, HR5211C, HM0860C, HM0870C, HM0871C, HM1111C, HM1101C, HM1203C, HM1213C, HM1214C

Cinzel de punta



Longitud (mm)	Tipo	Parte No.
400	(Auto afilable)	B-10621

Cinceles para martillos rotativos y demolidores SDS-MAX



Para modelo:

HR3540C, HR3541FC, HR4001C, HR4002, HR4010C, HR4011C, HR4501C, HR4510C, HR4511C, HR5201C, HR5210C, HR5211C, HM0860C, HM0870C, HM0871C, HM1111C, HM1101C, HM1203C, HM1213C, HM1214C

Cinzel de punta SDS-MAX

(Para demoler concreto)



Longitud	Tipo	No. Parte
300mm	-	D-36463
450mm	-	D-36479

Cinzel plano SDS-MAX

(Para quebrar, cantera, acanalar y remover grandes fragmentos de concreto)



Tamaño	Tipo	No. Parte
25 x 400mm	-	A-80818
12"	-	D-36485
18"	-	D-36491

Cinzel de pala

(Cinzel ancho para remover incrustaciones y salpicaduras de concreto solidificado)



Tamaño	Tipo	No. Parte
2" x 12"	Pala	D-36516
3" x 12"	Pala	D-36522

Cinzel punta 3/4" Hex

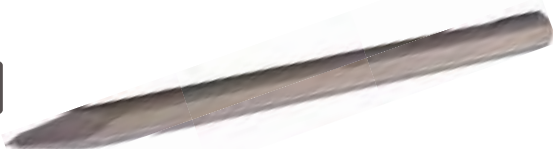

Tamaño	Tipo	No. Parte
12"	-	751421-A
18"	-	751422-A

Cinzel plano 3/4" Hex

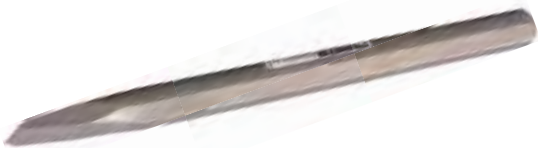

Longitud	Tipo	No. Parte
12" x 1"	Plano	751224-A
18" x 1"	Plano	751225-A

Cinzel punta 17mm



Tamaño	Tipo	No. Parte
50x280mm	Punta	D-08676
50x450mm	Punta	D-26571

Cinzel plano 17mm



Tamaño (mm)	Tipo	No. Parte
19x450mm	Plano	D-26602

Cinzel pala 17mm

(Para corte de asfalto)



Tamaño (mm)	Tipo	No. Parte
50x450mm	Pala	D-52532

Cinzel tipo pala



Tamaño (mm)	Tipo	No. Parte
105 x 400	-	A-25214

Cinzel punta Zanco Makita

Para HK1800

Maquinado en CNC y forjado con material fuerte aleado para durabilidad incrementada y mayor duración.



Tamaño	Tipo	No. Parte
8- 3/4"	Punta	B-06921

Cinzel pala 3/4" Hex



Tamaño	Tipo	No. Parte
12"	-	751227-A
12"	-	751226-A
18"	-	751623-A

Cinzel corte de asfalto 3/4" Hex



Tamaño	Tipo	No. Parte
15"	-	751624-A

Pisón y porta pisón 3/4" Hex



Longitud	Tipo	No. Parte
12"	Porta pisón	751716-A

Vástago porta pisón 3/4" Hex



Tamaño	Tipo	No. Parte
5"	-	751713-A

Cinzel punta 3/4" Hex.

Para HR3851



Tamaño	Tipo	No. Parte
12"	-	798146-1
18"	-	798147-9

Cinzel plano 3/4" Hex

Para HR3851



Tamaño	Tipo	No. Parte
12"	-	798139-8
18"	-	798140-3

Pisón y porta pisón 1-1/8"

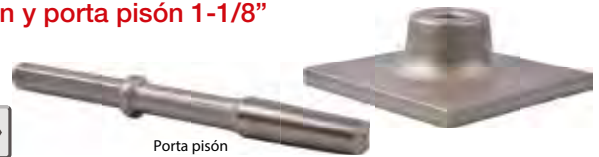

Tamaño	Tipo	No. Parte
6" x 6"	Pisón	751710-A
8" x 8"	Pisón	751711-A
Longitud		
15"	Porta pisón	751103-A

Cinzel punta zanco Hex 1-1/8"



*Caja 5 Piezas

Longitud	Tipo	No. Parte
350mm	Con collarín	D-65034
400mm	Autoafilable	B-10372
520mm	-	* D-21353-5
520mm	Con collarín	751420-A
520mm	Tipo Bosh	D-17675
520mm	Sin collarín	D-61569

Cinzel plano zanco Hex 1-1/8"



*Caja 5 Piezas

Longitud	Ancho	Características	No. Parte
20-1/2"	28mm	Cinzel liso, con collarín	751220-A
20-1/2"	28mm	Con collarín, reforzado súper cut. Cuerpo más ancho que permite más reafiladas	751222-A
520mm	28mm		* D-21369-5
420mm	28mm		D-17647
520mm	28mm		D-17681
520mm Sin collarín	28mm		D-61575

Cinzel pala zanco Hex 1- 1/8"



** Caja con 5 piezas

Longitud (mm)	Ancho	No. Parte
520mm	75mm	751221-A
520mm	75mm	** D-21347-5
400mm	75mm	D-29228
520mm	75mm	D-20725
520mm Sin collarin	75mm	D-61581

Cortador de asfalto zanco Hex 1-1/8"



Longitud (mm)	Ancho	No. Parte
580mm	140mm	751622-A

Cavador zanco Hex 1-1/8"



Longitud (In)	Tipo	No. Parte
12-1/2"	-	* 751621-A

Cilindro para clavos zanco Hex 1-1/8"



Longitud (In)	Tipo	No. Parte
5-1/2"	cilindro	* 751106-A

Perno para barra de tierra zanco Hex 1-1/8"



*Usar con martillos hexagonales 3/4", 1- 1/8"

Longitud (In)	Tipo	No. Parte
1-3/4" 14-1/2"	Perno	* 751101-A
1"x2-1/4"x 16"	Perno	751102-A

Martelina zanco Hex 1-1/8"



*Usar con martillos hexagonales 3/4", 1- 1/8"

Longitud (mm)	Tipo	No. Parte
14-3/4"	Martelina	* 751717-A

Cinzel punta Hex 1-3/16"



Diámetro	Largo	No. Parte
16"	-	798029-5
1-3/16"	310mm	D-15279
1-3/16"	400mm	D-15285

Cinzel plano Hexagonal 1-3/16"



*Especial para HM1500B

Diámetro	Largo	No. Parte
1-3/8"	406mm (Zanco Makita Largo)	*A-80597
1-3/16"	310mm (Frio)	D-34811
1-3/16"	310mm	D-15291
1-3/16"	400mm	D-15300

Cinzel pala Hexagonal 1-3/16"



Diámetro	Largo	No. Parte
1-3/16"	310x75mm	D-23868

Cinzel para asfalto Hexagonal 1-3/16"



Longitud	Tipo	No. Parte
1-3/16"	500x120mm	B-10300

Pisón Hexagonal 1-3/16"

Zanco Makita largo



Diámetro	Tipo	No. Parte
1-3/16"	200mm	A-31485

Martelina SDS-Max



Longitud	Tipo	No. Parte
10"	-	751715-A

Cinzel SDS-Max

Cinzel ancho para corte de asfalto



Longitud	Tipo	No. Parte
12"	-	751625-A

Carrito transportador para martillos



* No incluye herramienta ni cinceles

Uso	Empaque Piezas	No. Parte
Martillos HM1812, HM1802, HM1810, HM1801	1	D-54972

El equipo estándar (accesorios), las especificaciones y las fotografías pueden variar. Los accesorios pueden no estar incluidos desde origen con las herramientas, aunque se indiquen en este catálogo.



PUNTAS



Hex (H)



T



PZ



Phillips (Ph)



Cuadrada (Sq)



TH



Ranurada (SL)



Con magnetismo



Aleación de acero al cromo molibdeno



Para entrada cuadrada 3/8"



Para entrada cuadrada 1/2"



IMPACT XPS

La nueva línea de puntas IMPACT XPS de Makita es la mejor para terminar los trabajos de apretado. Las puntas IMPACT XPS están diseñadas para manejar las demandas de alta torsión de los usuarios profesionales en todos los oficios.



HORMA EXACTA

Puntas maquinadas para que ajusten el la mayoría de los tornillos



INGENIERÍA

Aros de pulsación de torsión Ayudan a distribuir la fuerza y prevenir quiebres



DURA HASTA 90 MÁS

QUE LAS BROCAS ESTÁNDAR

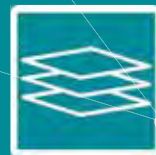

MEZCLA ÚNICA DE ACERO

La mezcla de acero de aleación de carbono se flexiona para prolongar la duración de las puntas



Puntas para atornillar

Tipo zanco hex. 1/4" (forma-C)			
A	Forma-C		
Tipo zanco hex. 1/4" (forma-E)			
		NZ	MZ
B	Forma-E (Single Ended)		
C	Forma-E (Double Ended)		

Tipo de tornillo

Phillips (Ph)	
Pozidriv	
Cuadrado (Sq)	

Torx (T)	
Torx de seguridad (T_H)	

Plano (SI)	
Hex (H)	

IMPACT XPS

Punta phillips 1" Impact XPS
Empaque 5pzs

NUEVO



Tamaño	Longitud	Empaque piezas	No. Parte
Ph1	1" (25mm)	5 Piezas	E-00549
Ph2	1" (25mm)	5 Piezas	E-00555
Ph3	1" (25mm)	5 Piezas	E-00561

Punta phillips 1" Impact XPS
Caja Tic-tac

NUEVO



Tamaño	Longitud	Empaque piezas	No. Parte
Ph2	1" (25mm)	15 Piezas	E-00664

Punta phillips 1" Impact XPS
Bolsa de plástico

NUEVO



Tamaño	Longitud	Empaque piezas	No. Parte
Ph2	1" (25mm)	25 Piezas	E-00692
Ph2R	1" (25mm)	25 Piezas	E-00701
Ph3	1" (25mm)	25 Piezas	E-00717

Punta phillips 2" Impact XPS
Empaque 3pzs

NUEVO



Tamaño	Longitud	Empaque piezas	No. Parte
Ph1	2" (50mm)	3 Piezas	E-00767
Ph2	2" (50mm)	3 Piezas	E-00773
Ph3	2" (50mm)	3 Piezas	E-00789

Punta plana 2" Impact XPS
Empaque 3pzs

NUEVO



Tamaño	Longitud	Empaque piezas	No. Parte
SL8	2" (50mm)	3 Piezas	E-00882
SL10	2" (50mm)	3 Piezas	E-00898

Punta phillips 2" Impact XPS
Empaque 5pzs

NUEVO



Tamaño	Longitud	Empaque piezas	No. Parte
Ph1	2" (50mm)	5 Piezas	E-00907
Ph2	2" (50mm)	5 Piezas	E-00913
Ph3	2" (50mm)	5 Piezas	E-00929

Punta plana 2" Impact XPS
Empaque 5pzs

NUEVO



Tamaño	Longitud	Empaque piezas	No. Parte
SL8	2" (50mm)	5 Piezas	E-01024
SL10	2" (50mm)	5 Piezas	E-01030

Punta phillips 2" Impact XPS

Caja tic-tac

NUEVO



Tamaño	Longitud	Empaque piezas	No. Parte
⊕ Ph2	2" (50mm)	15 Piezas	E-01046

Punta phillips 2" Impact XPS

Bolsa de plástico

NUEVO



Tamaño	Longitud	Empaque piezas	No. Parte
⊕ Ph2	2" (50mm)	25 Piezas	E-01080
⊕ Ph3	2" (50mm)	25 Piezas	E-01096

Punta phillips 3" Impact XPS

Empaque 2pzs

NUEVO



Tamaño	Longitud	Empaque piezas	No. Parte
⊕ Ph1	3" (76mm)	2 Piezas	E-01133
⊕ Ph2	3" (76mm)	2 Piezas	E-01149
⊕ Ph3	3" (76mm)	2 Piezas	E-01155

Punta phillips 3" Impact XPS

Caja tic-tac

NUEVO



NUEVO

NUEVO

Tamaño	Longitud	Empaque piezas	No. Parte
⊕ Ph2	3" (76mm)	15 Piezas	E-01258

Punta phillips 6" Impact XPS

Empaque 1pzs

NUEVO



Tamaño	Longitud	Empaque piezas	No. Parte
⊕ Ph2	6" (152mm)	1 pieza	E-01286

Punta phillips 6" Impact XPS

Bolsa de plástico

NUEVO



Tamaño	Longitud	Empaque piezas	No. Parte
⊕ Ph2	6" (152mm)	10 Piezas	E-01317

Punta torx 1" Impact XPS

Empaque 5pzs

NUEVO



Tamaño	Longitud	Empaque piezas	No. Parte
T10	1" (25mm)	5 Piezas	E-00608
T15	1" (25mm)	5 Piezas	E-00614
T20	1" (25mm)	5 Piezas	E-00620
T25	1" (25mm)	5 Piezas	E-00636
T27	1" (25mm)	5 Piezas	E-00642
T30	1" (25mm)	5 Piezas	E-00658

Punta torx 1" Impact XPS

Caja Tic-tac

NUEVO



Tamaño	Longitud	Empaque piezas	No. Parte
T20	1" (25mm)	15 Piezas	E-00670
T25	1" (25mm)	15 Piezas	E-00686

Punta torx 1" Impact XPS

Bolsa de plástico

NUEVO



Tamaño	Longitud	Empaque piezas	No. Parte
T15	1" (25mm)	25 Piezas	E-00723
T20	1" (25mm)	25 Piezas	E-00739
T25	1" (25mm)	25 Piezas	E-00745

Punta torx 2" Impact XPS

Empaque 3pzs

NUEVO



Tamaño	Longitud	Empaque piezas	No. Parte
T10	2" (50mm)	3 Piezas	E-00826
T15	2" (50mm)	3 Piezas	E-00832
T20	2" (50mm)	3 Piezas	E-00848
T25	2" (50mm)	3 Piezas	E-00854
T27	2" (50mm)	3 Piezas	E-00860
T30	2" (50mm)	3 Piezas	E-00876

Punta torx 2" Impact XPS

Empaque 5pzs

NUEVO



Tamaño	Longitud	Empaque piezas	No. Parte
T10	2" (50mm)	5 Piezas	E-00963
T15	2" (50mm)	5 Piezas	E-00979
T20	2" (50mm)	5 Piezas	E-00985
T25	2" (50mm)	5 Piezas	E-00991
T27	2" (50mm)	5 Piezas	E-01002
T30	2" (50mm)	5 Piezas	E-01018

Punta torx 2" Impact XPS

Caja tic-tac

NUEVO



Tamaño	Longitud	Empaque piezas	No. Parte
T20	2" (50mm)	15 Piezas	E-01068
T25	2" (50mm)	15 Piezas	E-01074

Punta torx 2" Impact XPS

Bolsa de plástico

NUEVO



Tamaño	Longitud	Empaque piezas	No. Parte
T20	2" (50mm)	25 Piezas	E-01111
T25	2" (50mm)	25 Piezas	E-01127

Punta torx 3" Impact XPS

Empaque 2pzs

NUEVO



Tamaño	Longitud	Empaque piezas	No. Parte
T10	3" (76mm)	2 Piezas	E-01199
T15	3" (76mm)	2 Piezas	E-01208
T20	3" (76mm)	2 Piezas	E-01214
T25	3" (76mm)	2 Piezas	E-01220
T27	3" (76mm)	2 Piezas	E-01236
T30	3" (76mm)	2 Piezas	E-01242

Punta torx 3" Impact XPS

Caja tic-tac

NUEVO



Tamaño	Longitud	Empaque piezas	No. Parte
T25	3" (76mm)	15 Piezas	E-01270

Punta torx 6" Impact XPS

Empaque 1pz

NUEVO



Tamaño	Longitud	Empaque piezas	No. Parte
T25	6" (152mm)	1 Pieza	E-01301

Punta torx 6" Impact XPS

Bolsa de plástico

NUEVO



Tamaño	Longitud	Empaque piezas	No. Parte
T25	6" (152mm)	10 Piezas	E-01339

Adaptador magnético "MAG-BOOST" Impact XPS

Convierte cualquier punta reforzada Impact XPS en punta magnética



NUEVO

Descripción	Empaque Piezas	No. Parte
Anillo magnetizador para puntas "Mag Boost" Impact XPS	1	E-01345

Adaptadores magnéticos Impact XPS

Diseñados para soportar la potencia extrema de los atornilladores de impacto de alta torsión



NUEVO

Descripción	Medida	Empaque Piezas	No. Parte
Adaptador Magnético XPS	2-3/8"	1	E-01351
Adaptador Magnético XPS	3"	1	E-01367
Adaptador Magnético XPS	6"	1	E-01373
Adaptador Magnético XPS	12"	1	E-01389

Adaptadores magnéticos Impact XPS

Bolsa de plástico

Diseñados para soportar la potencia extrema de los atornilladores de impacto de alta torsión



NUEVO

Descripción	Medida	Empaque Piezas	No. Parte
Adaptador Magnético XPS	2-3/8"	10 pzs	E-01395
Adaptador Magnético XPS	3"	10 pzs	E-01404
Adaptador Magnético XPS	6"	10 pzs	E-01410
Adaptador Magnético XPS	12"	10 pzs	E-01426

Set de adaptador magnético Impact XPS

Empaque 3pzs



NUEVO

Descripción	Medida	Empaque Piezas	No. Parte
Set de adaptador magnético Impact XPS (1/4", 5/16", 3/8")	2-9/16" (65mm)	1	E-01432

Adaptadores magnéticos Impact XPS

Empaque 2pzs



NUEVO

Descripción	Medida	Zanco	Empaque Piezas	No. Parte
Adaptador Magnético XPS	1/4" x 2-9/16"	HEX	2	E-01448
Adaptador Magnético XPS	5/16" x 2-9/16"	HEX	2	E-01454
Adaptador Magnético XPS	3/8" x 2-9/16"	HEX	2	E-01460
Adaptador Magnético XPS	7/16" x 2-9/16"	HEX	2	E-01476
Adaptador Magnético XPS	1/2" x 2-9/16"	HEX	2	E-01482

Adaptadores magnéticos Impact XPS

Bolsa de plástico

NUEVO



Descripción	Medida	Zanco	Empaque Piezas	No. Parte
Adaptador Magnético XPS	1/4" x 2-9/16"	HEX	10	E-01498
Adaptador Magnético XPS	5/16" x 2-9/16"	HEX	10	E-01507
Adaptador Magnético XPS	3/8" x 2-9/16"	HEX	10	E-01513

Adaptadores magnéticos Impact XPS

Empaque 1pz

NUEVO



Descripción	Medida	Zanco	Empaque Piezas	No. Parte
Adaptador Magnético XPS	1/4" x 6"	HEX	1 pz	E-01529
Adaptador Magnético XPS	5/16" x 6"	HEX	1 pz	E-01535
Adaptador Magnético XPS	3/8" x 6"	HEX	1 pz	E-01541

Adaptadores para dado Impact XPS

Empaque 1pz

NUEVO

Esfera de retención que permite sujetar el dado de manera segura



Descripción	Medida	Zanco	Empaque Piezas	No. Parte
Adaptador Magnético XPS	Cuadro 1/4" x 2"	HEX	1 pz	E-01579
Adaptador Magnético XPS	Cuadro 3/8" x 2"	HEX	1 pz	E-01585
Adaptador Magnético XPS	Cuadro 1/2" x 2"	HEX	1 pz	E-01591

Adaptadores para dado Impact XPS

Bolsa de plástico

NUEVO



Descripción	Medida	Zanco	Empaque Piezas	No. Parte
Adaptador Magnético XPS	Cuadro 1/4" x 2"	HEX	10 pzs	E-01616
Adaptador Magnético XPS	Cuadro 3/8" x 2"	HEX	10 pzs	E-01622
Adaptador Magnético XPS	Cuadro 1/2" x 2"	HEX	10 pzs	E-01638

Juego de adaptadores para dado Impact XPS

Varias medidas

NUEVO

Esfera de retención que permite sujetar el dado de manera segura



Descripción	Medida	Zanco	Empaque Piezas	No. Parte
Juego de adaptadores magnético Impact XPS	Cuadro 1/4" x 2" Cuadro 3/8" x 2" Cuadro 1/2" x 2"	HEX	3pzs	E-01600

Juego de puntas Impact XPS

Varias medidas

NUEVO



Contiene	Tipo	Empaque piezas	No. Parte
Adaptador magnético 1-3/4" (2pzs) Portapuntas 2-3/8", 25 puntas de inserción de 1", 6 puntas reforzadas de 2", adaptador de dado 1/4"	1/4" Hex	35	E-01666
Adaptador magnético 1-3/4" (2pzs) Portapuntas 2-3/8", 31 puntas de inserción de 1", 10 puntas reforzadas de 2", adaptador de dado 1/4"	1/4" Hex	45	E-01650
Adaptador magnético 1-3/4" (2pzs) Portapuntas 2-3/8", 1 adaptador magnético, 45 puntas de inserción de 1", 10 puntas reforzadas de 2", adaptador de dado 1/4"	1/4" Hex	60	E-01644

Juego de dados y adaptador Hex Impact XPS

Medidas en pulgadas

NUEVO

Cubierta con Óxido negro para resistir la corrosión

Dados con 6 puntos de alta duración para aplicaciones de torsión extrema

Adaptador de dado Entrada 1/4" Hex



Zapata flexible para almacenamiento de dados y adaptador

Contiene	Tipo	Empaque piezas	No. Parte
Dados de impacto de 5/16", 3/8", 7/16", 1/2", 9/16", 5/8", 11/16", 3/4", 7/8", cuadro 3/8" x 1/4" adaptador de dado entrada Hex	1/4" Hex con cuadro 3/8"	10	E-01672
Dados de impacto de 3/16", 1/4", 5/16", 3/8", 7/16", 1/2", 9/16", cuadro 1/4" x 1/4" adaptador de dado entrada Hex	1/4" Hex con cuadro 1/4"	8	E-01703

Juego de dados y adaptador Hex Impact XPS

Medidas en Sistema métrico decimal

NUEVO

Cubierta con Óxido negro para resistir la corrosión

Dados con 6 puntos de alta duración para aplicaciones de torsión extrema

Adaptador de dado Entrada 1/4" Hex



Zapata flexible para almacenamiento de dados y adaptador

Contiene	Tipo	Empaque piezas	No. Parte
Dados de impacto de 8mm, 10mm, 14mm, 15mm, 17mm, 18mm, 21mm; cuadro de 3/8" x 1/4" adaptador de dado entrada Hex	1/4" Hex con cuadro 3/8"	10	E-01688
Dados de impacto de 6mm, 7mm, 8mm, 10mm, 11mm, 12mm, 13mm; adaptador de dado tracción de 1/4" x entrada 1/4" Hex	1/4" Hex con cuadro 1/4"	8	E-01694

Punta de torsión súper delgada



Impact GOLD

Delgada pero con alta durabilidad
La punta visible aumenta la eficiencia del trabajo

Tamaño	Longitud (mm)	Zanco tipo	Empaque piezas	No. Parte	
+	Ph 2	25	Forma C	2	B-62337
+	PZ 2	25	Forma C	2	B-62343
	PZ 2	50	Forma E (MZ)	2	B-62365

Punta de torsión



Con Magnético

Impact GOLD

* Para tornillos de tablaroca y madera
** Para tornillos auto perforantes en metal



Tamaño	Longitud (mm)	Zanco tipo	Empaque Piezas	No. Parte	
+	** Ph 2 (Enduro)	50	MZ-B	2	E-03274
	Ph 3	50	MZ-B	2	B-28189

Punta de torsión



Con Magnético



Impact GOLD

Tamaño	Longitud (mm)	Zanco tipo	Empaque Piezas	No. Parte	
+	T 10	50	MZ-B	2	B-28226
	T 25	50	MZ-B	2	B-28254
+	Sq 1	50	MZ-B	2	B-28195
	Sq 2	50	MZ-B	2	B-28204
	Sq 3	50	MZ-B	2	B-28210

Punta de torsión

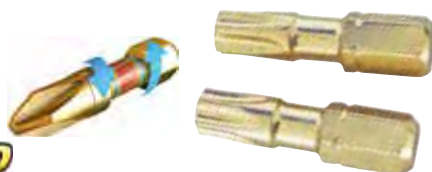

Impact GOLD

Tamaño	Longitud (mm)	Zanco tipo	Empaque Piezas	No. Parte	
+	Ph 1	25	A	2	B-28329 / E-03121
	Ph 2	25	A	5	B-28357
+	Pz 1	25	A	2	B-28444
	Pz 2	25	A	5	B-28472
+	T 10	25	A	2	B-28391
	T 20	25	A	2	B-28416
	T 25	25	A	2	B-28422
	T30	25	A	2	B-28379
+	Sq2	25	A	2	B-28438

Puntas para atornillar

Triptico con 1 pieza



Impact GOLD

Tamaño	Longitud	Tipo	Empaque Piezas	No. Parte	
+	Pz 2	2"	Pozidriv	1	B-28933

Porta punta con torsión



Impact GOLD

Longitud (mm)	Zanco tipo	Empaque piezas	No. Parte
66	MZ-B	1	B-28525 / E-03399

Porta punta ultra magnética con torsión



Impact GOLD

*Caja con 24 piezas (Display p/venta individual)

Longitud (mm)	Zanco tipo	Empaque Piezas	No. Parte
79	MZ-B	79	B-28531
79	MZ-B	79	*B-28531-24

Adaptador de dado



Impact GOLD

Tamaño	Longitud (mm)	Zanco tipo	Empaque piezas	No. Parte
SQ 3/8"	56	MZ-B	1	E-03420
SQ 1/2"	56	MZ-B	1	B-28553 / E-03436

Guía buscadora magnética 8mm Impact Gold

Impact GOLD



Tamaño	Zanco	Zanco tipo	Empaque piezas	No. Parte
8mm(5/16")	1/4" Hex	MZ	1	B-40266
8mm(5/16")	1/4" Hex	MZ	3	B-40353

Juego de guía buscadora magnética 8mm Impact Gold

Impact GOLD



Tamaño	Zanco	Zanco tipo	Empaque piezas	No. Parte
9.6mm(3/8")	1/4" Hex	MZ	3	B-40369
10mm	1/4" Hex	MZ	3	B-40375
8.0mm / 9.6mm / 10mm	1/4" Hex	MZ	3	B-40381

Juego de puntas de torsión 11 Piezas

Impact GOLD



Tamaño	Longitud (mm)	Zanco tipo	Empaque piezas	No. Parte
Ph1, Ph2, Ph3	25	A	1	B-28597
Pz1, Pz2, Pz3	25	A		
T15, T20, T25, T30	25	A		
Torsion Bit Holder	66	MZ-B		

Juego de puntas de torsión magnéticas 11 piezas

Impact GOLD



Tamaño	Longitud (mm)	Zanco tipo	Empaque piezas	No. Parte
⊕ Ph1, Ph2, Ph3	25	A	1	B-30754
⊕ Pz1, Pz2, Pz3	25	A		
⊕ T15, T20, T25, T30	25	A		
Soporte de puntas de torsión	79	MZ-B		

Juego de puntas impact gold c/magnetizador 26 pzs

26 pzs

Impact GOLD

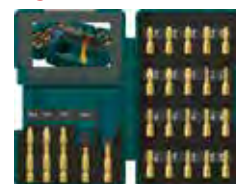

Contiene	Empaque piezas	No. Parte
Puntas cortas de torsión (25mm) ⊕ 1xPh1, 2xPh2, 1xPh3 ⊕ 1xPz1, 2xPz2, 1xPz3 ⊕ 1xSq1, 2xSq2, 1xSq3 ⊕ 1xT10, 1xT15, 2xT20, 2xT25, 2xT30 Puntas torsión (50mm) ⊕ 1xPh2 ⊕ 1xPz2 ⊕ 1xSq2 ⊕ 1xT25 Anillo Magnetizador para puntas "Mag Boost" Impact Gold" Porta punta ultramagnética con torsión	1 Juego	B-49915

Juego de puntas impact gold 40pzs

40pzs

Impact GOLD



Contiene	Empaque piezas	No. Parte
Puntas cortas de torsión (25mm) C-form ⊕ 2xPh1, 8xPh2, 2xPh3 ⊕ 2xSq1, 8xSq2, 2xSq3 ⊕ 1xT10, 2xT15, 2xT20, 5xT25, 1xT27, 2xT30 Adaptador magnético 50mm 1/4", zanco Hex 1/4" E Form (MZ) Adaptador magnético 50mm 5/16" (8mm), zanco Hex 1/4" E Form (MZ) Porta punta con torsión 60mm	1 Juego 40pzs	B-69157

Juego de puntas impact gold 40pzs

40pzs

Impact GOLD



Contiene	Empaque piezas	No. Parte
Puntas cortas de torsión (25mm) C-form ⊕ 1xPh1, 4xPh2, 1xPh3 ⊕ 2xSq1, 8xSq2, 2xSq3 ⊕ 1xT10, 2xT15, 2xT20, 5xT25, 1xT27, 2xT30 ⊕ 2xPz1, 8xPz2, 2xPz3, Adaptador magnético 50mm 1/4", zanco Hex 1/4" E Form (MZ) Adaptador magnético 50mm 5/16" (8mm), zanco Hex 1/4" E Form (MZ) Porta punta con torsión 60mm	1 Juego 40pzs	B-69179

Caja flip top (Impact Gold)

Impact GOLD



Tamaño	Longitud (mm)	Zanco tipo	Empaque piezas	No. Parte	
+	Ph 2	25	A	15	B-39512-10
○	Sq 2	25	A	15	B-39556

Caja flip top (Impact Gold)

Con magnético



Impact GOLD

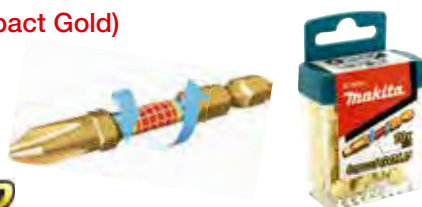

Tamaño	Longitud (mm)	Zanco tipo	Empaque piezas	No. Parte	
+	Pz 2	50	MZ	10	B-39540

Puntas impact gold

Con anillo magnetizador



Impact GOLD

Contiene	Empaque Piezas	No. Parte
Puntas PZ2 x 2" con magnetizador	Set de 5 piezas	B-42472
Puntas T25 x 2" con magnetizador	Set de 5 piezas	B-42494
Juego de puntas PH,PZ,T25x2" con magnetizador	Set de 5 piezas	B-42503
Puntas cuadro 2x2" con magnetizador	Set de 5 piezas	B-42519

Bote magnético c/puntas impact gold

6pzs



Impact GOLD

Tamaño	Empaque piezas	No. Parte	
+	Ph2	6 Piezas	B-52912-6

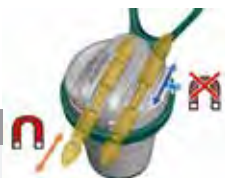

Serie de puntas **IMPACT BLACK**

20% más durable que la línea estándar

IMPACT
Impact driver's accessory series
BLACK

Revestimiento que evita la oxidación proporcionando mayor durabilidad



Mejor fuerza de torsión

Ideal para uso profesional
(Electricistas, Constructores, carpinteros, etc.)

Punta de torsión 1"
IMPACT BLACK



	Tamaño	Longitud (mm)	Zanco tipo	Empaque Piezas	No. Parte
+	Ph1	25 (1")	Forma C	2	B-63600
	Ph2	25 (1")	Forma C	2	B-63616
	Ph3	25 (1")	Forma C	2	B-63622
+	Pz1	25 (1")	Forma C	2	B-63638
	Pz2	25 (1")	Forma C	2	B-63644
	Pz3	25 (1")	Forma C	2	B-63650
*	T15	25 (1")	Forma C	2	B-63666
	T20	25 (1")	Forma C	2	B-63672
	T25	25 (1")	Forma C	2	B-63688
	T30	25 (1")	Forma C	2	B-63694
	T40	25 (1")	Forma C	2	B-63703

Punta de torsión 2" IMPACT BLACK



	Tamaño	Longitud (mm)	Zanco tipo	Empaque piezas	No. Parte
+	Ph1	50 (2")	MZ	2	B-63719
	Ph2	50 (2")	MZ	2	B-63725
	Ph3	50 (2")	MZ	2	B-63731
+	Pz1	50 (2")	MZ	2	B-63747
	Pz2	50 (2")	MZ	2	B-63753
	Pz3	50 (2")	MZ	2	B-63769
*	T15	50 (2")	MZ	2	B-63775
	T20	50 (2")	MZ	2	B-63781
	T25	50 (2")	MZ	2	B-63797
	T30	50 (2")	MZ	2	B-63806
	T40	50 (2")	MZ	2	B-63812

Porta punta IMPACT BLACK



Tamaño	Longitud	Empaque piezas	No. Parte
	60 mm	1 Pieza	B-66802

Adaptador para dado IMPACT BLACK



Tamaño	Longitud	Empaque piezas	No. Parte
cuadro 1/2"	50 mm	1 Pieza	B-66874

Dado magnético IMPACT BLACK



Tamaño	Longitud	Empaque piezas	No. Parte
6	50 mm	1 Pieza	B-66824
8	50 mm	1 Pieza	B-66830
10	50 mm	1 Pieza	B-66846
13	50 mm	1 Pieza	B-66852

Juego de puntas IMPACT BLACK



Incluye	Empaque piezas	No. Parte
Puntas forma C, 25mm: PH1, PH2x3, PH3, PZ1, PZ2x3, PZ3, T15, T20x2, T25x2, T30 Puntas forma E (MZ), 50mm: PH1, PH2x2, PH3, PZ1, PZ2x3, PZ3, T15, T20, T25x2, T30, SL0.8x5.5 Adaptador magnético (60mm), dados magnéticos 50mm (6mm, 8mm, 10mm, 13mm)	35	B-66880
Puntas forma C, 25mm: PH1, PH2x3, PH3, PZ1, PZ2x3, PZ3, T15, T20x2, T25x2, T30 Puntas forma E (MZ), 50mm: PH2, PZ2, T15, T20, T25, T30 Adaptador magnético (60mm) Dados magnéticos 50mm (6mm, 8mm, 10mm) Guía buscadora (80mm) Brocas HSS 1/4" (varias medidas)	33	B-66896





IMPACTX™

IMPACT X
Línea Profesional

Diseñadas específicamente para soportar las exigencias de los usuarios profesionales que requieren brocas de trabajo comercial y accesorios de sujeción que soporten la fuerza de aplicaciones de atornillado de alto rendimiento

Punta phillips 1" Impact X



IMPACTX

Tamaño	Longitud	Empaque piezas	No. Parte
⊕ Ph1	1" (25mm)	2 Piezas	A-96453
⊕ Ph2	1" (25mm)	2 Piezas	A-96469
⊕ Ph3	1" (25mm)	2 Piezas	A-96481

Punta phillips 1" #2 Impact X
Caja Tic tac



* A-97302-10

Tamaño	Longitud	Empaque piezas	No. Parte
⊕ Ph2	1" (25mm)	Caja c/10Pzs x25	* A-97302-10

Punta phillips 1" Impact X
Bolsa de plastico



IMPACTX

Tamaño	Longitud	Empaque piezas	No. Parte
⊕ Ph1	1" (25mm)	50	A-98821
⊕ Ph2	1" (25mm)	50	A-96475
⊕ Ph3	1" (25mm)	50	A-96497

Punta phillips 1" #2 Impact X
Vitrolero



IMPACTX

Tamaño	Longitud	Empaque piezas	No. Parte
⊕ Ph2	1" (25mm)	200 Piezas	A-97324

El equipo estándar (accesorios), las especificaciones y las fotografías pueden variar. Los accesorios pueden no estar incluidos desde origen con las herramientas, aunque se indiquen en este catálogo.



Punta phillips 1" #2 Impact X

Punta PH2 R para panel de yeso



Tamaño	Longitud	Empaque piezas	No. Parte
⊕ Ph2	1" (25mm)	2 Piezas	A-98837

Punta phillips 1" #2 Impact X

Punta PH2 R para panel de yeso / caja Tic tac



* A-98843-10



Tamaño	Longitud	Empaque piezas	No. Parte
⊕ Ph2	1" (25mm)	Caja c/10 pzs x25	* A-98843-10

Punta phillips 1" #2 Impact X

Punta PH2 R para panel de yeso
Bolsa de plástico



Tamaño	Longitud	Empaque piezas	No. Parte
⊕ Ph2	1" (25mm)	50 Piezas	A-98859

Punta phillips 1" Impact X

Punta PH2 R para panel de yeso
Vitrolero



Tamaño	Longitud	Empaque piezas	No. Parte
⊕ Ph2	1" (25mm)	200 Piezas	A-98865

Punta phillips 2" Impact X



Tamaño	Longitud	Empaque piezas	No. Parte
⊕ Ph1x2"	2" (51mm)	2 Piezas	A-96643
⊕ Ph2x2"	2" (51mm)	2 Piezas	A-96659
⊕ Ph3x2"	2" (51mm)	2 Piezas	A-96687
⊕ Ph2x2"	2" (51mm)	5 Piezas	A-96665

Punta phillips 2" Impact X

Caja Tic tac



* A-96671-10



Tamaño	Longitud	Empaque piezas	No. Parte
⊕ Ph2x2"	2" (51mm)	10 cajas c/15 Pzs	* A-96671-10

Punta phillips 2" Impact X

Vitrolero



Tamaño	Longitud	Empaque piezas	No. Parte
⊕ Ph2x2"	2" (51mm)	100	A-97368

Punta phillips 2" Impact X

Bolsa de plástico



Tamaño	Longitud	Empaque piezas	No. Parte
⊕ Ph1x2"	2" (51mm)	50	A-98974
⊕ Ph2x2"	2" (51mm)	50	A-98980
⊕ Ph3x2"	2" (51mm)	50	A-98996

Punta phillips 3 1/2" Impact X



IMPACTX

Tamaño	Longitud	Empaque piezas	No. Parte
⊕ Ph1	3 1/2"	1 pza.	A-96811

Punta phillips 3 1/2" Impact X



IMPACTX

Tamaño	Longitud	Empaque piezas	No. Parte
⊕ Ph2	3 1/2"	1 Pieza	A-96827
⊕ Ph3	3 1/2"	1 Pieza	A-96833

Punta phillips 3 1/2" Impact X



IMPACTX

Tamaño	Longitud	Empaque piezas	No. Parte
⊕ Ph1	3 1/2"	50 Piezas	A-99100
⊕ Ph2	3 1/2"	50 Piezas	A-99116
⊕ Ph3	3 1/2"	50 Piezas	A-99122

Punta phillips 6" Impact X



IMPACTX

Tamaño	Longitud	Empaque piezas	No. Parte
⊕ Ph1x6"	6"	1	A-96877
⊕ Ph2x6"	6"	1	A-96883
⊕ Ph3x6"	6"	1	A-96899

Punta phillips 6" Impact X



IMPACTX

Tamaño	Longitud	Empaque piezas	No. Parte
⊕ Ph1x6"	6"	25	A-99166
⊕ Ph2x6"	6"	25	A-99172
⊕ Ph3x6"	6"	25	A-99188

Punta phillips 12" Impact X



IMPACTX

Tamaño	Longitud	Empaque piezas	No. Parte
⊕ Ph2	12"	1 pieza	A-96914

Punta phillips 12" Impact X



IMPACTX

Tamaño	Longitud	Empaque piezas	No. Parte
⊕ Ph1x12"	12"	10	A-99225
⊕ Ph2x12"	12"	10	A-99231
⊕ Ph3x12"	12"	10	A-99247

Puntas planas Impact X



IMPACTX

Tamaño	Longitud	Empaque piezas	No. Parte
⊖ SI 8	1" (25mm)	2	A-96621
⊖ SI 10	1" (25mm)	2	A-96637
⊖ SI 8	2"	2	A-96796
⊖ SI 10	2"	2	A-96805

Punta torx 1" Impact X



Tamaño	Longitud	Empaque piezas	No. Parte
T10	1" (25mm)	2	A-96540
T15	1" (25mm)	2	A-96556
T20	1" (25mm)	2	A-96562
T25	1" (25mm)	2	A-96578
T27	1" (25mm)	2	A-96584
T30	1" (25mm)	2	A-96590
T40	1" (25mm)	2	A-96609

Punta torx 2" Impact X



Tamaño	Longitud	Empaque piezas	No. Parte
T10	2"	2	A-96724
T15	2"	2	A-96730
T20	2"	2	A-96746
T25	2"	2	A-96752
T27	2"	2	A-96768
T30	2"	2	A-96774
T40	2"	2	A-96780

Punta torx 1" Impact X

Bolsa de plástico



Tamaño	Longitud	Empaque piezas	No. Parte
T10	1" (25mm)	50	A-98902
T15	1" (25mm)	50	A-98918
T20	1" (25mm)	50	A-98924
T25	1" (25mm)	50	A-98930
T27	1" (25mm)	50	A-98946
T30	1" (25mm)	50	A-98952
T40	1" (25mm)	50	A-98968

Punta torx 2" Impact X

Bolsa de plástico



Tamaño	Longitud	Empaque piezas	No. Parte
T15	2"	50	A-99041
T20	2"	50	A-99057
T25	2"	50	A-99063
T27	2"	50	A-99079
T30	2"	50	A-99085
T40	2"	50	A-99091

Set de puntas torx 1" Impact X

7 piezas



Tamaño	Longitud	Empaque piezas	No. Parte
T10 T20 T27 T40 T15 T25 T30	1" (25mm)	7	A-96615

Punta cuadro 1" Impact X

Bolsa de plástico



Tamaño	Longitud	Empaque piezas	No. Parte
Sq1	1" (25mm)	2 Piezas	A-96506
Sq2	1" (25mm)	2 Piezas	A-96512
Sq3	1" (25mm)	2 Piezas	A-96534

Punta cuadro 1" Impact X

Bolsa de plastico



IMPACTX

Tamaño	Longitud	Empaque piezas	No. Parte
○ Sq1	1" (25mm)	50 Piezas	A-98887
○ Sq2	1" (25mm)	50 Piezas	A-96528
○ Sq3	1" (25mm)	50 Piezas	A-98893

Punta cuadro Impact X

25 piezas x 10 cajas



IMPACTX

Tamaño	Longitud	Empaque piezas	No. Parte
○ Sq2	1" (25mm)	25 piezas (10 cajas)	A-97330-10
○ SQ2	2" (51mm)	25 piezas (10 cajas)	A-97405-10

Punta cuadro 2" Impact X



IMPACTX

Tamaño	Longitud	Empaque piezas	No. Parte
○ SQ1x2"	2" (51mm)	2 Piezas	A-96693
○ SQ2x2"	2" (51mm)	2 Piezas	A-96702
○ SQ2x2"	2" (51mm)	2 Piezas	A-96718

Punta cuadro 2" Impact X

Bolsa de plastico



IMPACTX

Tamaño	Longitud	Empaque piezas	No. Parte
○ SQ1x2"	2" (51mm)	50	A-99007
○ SQ2x2"	2" (51mm)	50	A-99013
○ SQ3x2"	2" (51mm)	50	A-99029

Punta cuadro 3 1/2" Impact X



IMPACTX

Tamaño	Longitud	Empaque piezas	No. Parte
○ SQ1	3 1/2"	1 Pieza	A-96849
○ SQ2	3 1/2"	1 Pieza	A-96855
○ SQ3	3 1/2"	1 Pieza	A-96861

Punta cuadro 3 1/2" Impact X



IMPACTX

Tamaño	Longitud	Empaque piezas	No. Parte
○ SQ1	3 1/2"	50	A-99138
○ SQ2	3 1/2"	50	A-99144
○ SQ3	3 1/2"	50	A-99150

Punta cuadro 6" Impact X



IMPACTX

Tamaño	Longitud	Empaque piezas	No. Parte
○ SQ2	6"	1	A-96908

Punta cuadro 6" Impact X



IMPACTX

Tamaño	Longitud	Empaque piezas	No. Parte
○ SQ1	6"	25	A-99194
○ SQ2	6"	25	A-99203
○ SQ3	6"	25	A-99219

Punta cuadro 12" Impact X



IMPACTX

Tamaño	Longitud	Empaque piezas	No. Parte
○ SQ1	12"	10	A-99253
○ SQ2	12"	10	A-99269
○ SQ3	12"	10	A-99275

Adaptador magnético Impact X

Solo para puntas de 1"



Diseño en 2 piezas, para mayor movilidad

Longitud	Empaque piezas	No. Parte
2-3/8" (60mm)	1	A-96920
3" (76mm)	1	A-96942
6" (152mm)	1	A-96958
12" (305mm)	1	A-96964

Adaptador magnético Impact X

Solo para puntas de 1"



Diseño en 2 piezas, para mayor movilidad

Longitud	Empaque piezas	No. Parte
2-3/8" (60mm)	10	A-96936
3" (76mm)	10	A-99281
6" (152mm)	10	A-99297
12" (305mm)	10	A-99306

Adaptador magnético Impact X

Solo para puntas de 1"



Diseño en una pieza, para mayor resistencia

Longitud	Empaque piezas	No. Parte
2-3/8" (60mm)	1	A-96970
3" (76mm)	1	A-96992
6" (152mm)	1	A-97003
12" (305mm)	1	A-97019

Adaptador magnético Impact X

Solo para puntas de 1"



Diseño en una pieza, para mayor resistencia

Longitud	Empaque piezas	No. Parte
2-3/8" (60mm)	10	A-96986
3" (76mm)	10	A-99312
6" (152mm)	10	A-99328
12" (305mm)	10	A-99334

Guía buscadora Impact X



Longitud	Empaque piezas	No. Parte
3" (76mm)	1	A-97075
4-3/4"	1	A-97081

Guía buscadora Impact X

Bolsa de plástico



Longitud	Empaque piezas	No. Parte
3" (76mm)	10	A-99340
4-3/4"	10	A-99356

Guía buscadora Impact X

Vitrolero



Longitud	Empaque piezas	No. Parte
3" (76mm)	25	A-97380
4-3/4"	25	A-97396

Adaptador para dado, cuadro 1/4" Impact X



Longitud	Cuadro	Zanco	Empaque piezas	No. Parte
2"	1/4"	1/4" Hex	1	A-97025
6"	1/4"	1/4" Hex	1	A-97031
12"	1/4"	1/4" Hex	1	A-97047

Adaptador para dado, cuadro 1/4" Impact X

Bolsa de plástico



Longitud	Cuadro	Zanco	Empaque piezas	No. Parte
2"	1/4"	1/4" Hex	10	A-99362
6"	1/4"	1/4" Hex	10	A-99378
12"	1/4"	1/4" Hex	10	A-99384

Adaptador para dado, cuadro 3/8" Impact X

IMPACTX



Longitud	Cuadro	Zanco	Empaque piezas	No. Parte
2"	3/8"	1/4" Hex	1	A-97053
2"	3/8"	1/4" Hex	10	A-99390
6"	3/8"	1/4" Hex	10	A-99409
12"	3/8"	1/4" Hex	10	A-99415

Adaptador para dado, cuadro 1/2" Impact X

IMPACTX



Longitud	Cuadro	Zanco	Empaque piezas	No. Parte
2"	1/2"	1/4" Hex	1	A-97069
2"	1/2"	1/4" Hex	3	A-97673
2"	1/2"	1/4" Hex	10	A-99421
6"	1/2"	1/4" Hex	10	A-99437
12"	1/2"	1/4" Hex	10	A-99443

Puntas magnéticas Impact X

IMPACTX



Longitud	Medida	Tipo	Empaque piezas	No. Parte
2-9/16"	1/4"	Hex	1	A-97112
6"	1/4"	Hex	1	A-97134
1-3/4"	5/16"	Hex	1	A-97140
2-9/16"	5/16"	Hex	1	A-97162
6"	5/16"	Hex	1	A-97184
1-3/4"	3/8"	Hex	1	A-97190
2-9/16"	3/8"	Hex	1	A-97215
6"	3/8"	Hex	1	A-97237
1-3/4"	7/16"	Hex	1	A-97243
2-9/16"	7/16"	Hex	1	A-97259

Puntas magnéticas Impact X

IMPACTX



Longitud	Medida	Tipo	Empaque piezas	No. Parte
1-3/4"	1/4"	Hex	1	A-97097
1-3/4"	1/4"	Hex	10	A-97106
6"	1/4"	Hex	10	A-97128

Puntas magnéticas Impact X

IMPACTX

Longitud	Medida	Tipo	Empaque piezas	No. Parte
1-3/4"	5/16"	Hex	3	A-97651
1-3/4"	3/8"	Hex	3	A-97667
1-3/4"	1/4"	Hex	3	A-97645

Dados Impact X

Bolsa de plástico



IMPACTX

Longitud	Medida	Tipo	Empaque piezas	No. Parte
6"	1/4"	Hex	10	A-99459
1-3/4"	5/16"	Hex	10	A-97156
2-9/16"	5/16"	Hex	10	A-97178
6"	5/16"	Hex	10	A-99465
1-3/4"	3/8"	Hex	10	A-97209
2-9/16"	3/8"	Hex	10	A-97221
6"	3/8"	Hex	10	A-99471
1-3/4"	7/16"	Hex	10	A-99487
2-9/16"	7/16"	Hex	10	A-99493
6"	7/16"	Hex	10	A-99502

Juego de puntas magnéticas Impact X

Varias medidas

IMPACTX

* A-97639



Longitud	Medidas	Tipo	Empaque piezas	No. Parte
1-3/4"	1/4" - 5/16" - 3/8"	Hex	3	A-97265
1-3/4"	1/4" - 5/16" 3/8" - 7/16"	Hex	4	A-97639
2-9/16"	1/4" - 5/16" - 3/8"	Hex	3	A-97689
6"	1/4" - 5/16" - 3/8"	Hex	3	A-97695

Juego de puntas Impact X

Varias medidas

IMPACTX



Contiene	Tipo	Empaque piezas	No. Parte
28 puntas de 1", 4 puntas de 2" 1 adaptador magnético, 2 dados de 1-3/4"	1/4" Hex	35	A-98326
29 puntas de 1", 5 puntas de 2", 2 puntas de 3-1/2" 1 adaptador magnético, 3 dados de 1-3/4"	1/4" Hex	40	A-98332
32 puntas de 1", 10 puntas de 2", 2 puntas de 3-1/2", 2 adaptador magnético, 1 adaptador para dado 2" 3 dados de 1-3/4"	1/4" Hex	50	A-98348

Punta para atornillar forma E 3-1/2"



Tamaño	Longitud (mm)	Zanco tipo	Empaque piezas	No. Parte
Ph1	90	MZ	1	B-57772
Ph2	90	MZ	1	B-57788
Sq1	90	MZ	1	B-57803
Sq2	90	MZ	1	B-57819
Sq3	90	MZ	1	B-57825
Pz1	90	MZ	1	B-59879
Pz2	90	MZ	1	B-59885
Pz3	90	MZ	1	B-59891
T15	90	MZ	1	B-59900
T20	90	MZ	1	B-59916
T25	90	MZ	1	B-59922
T30	90	MZ	1	B-59938

Punta para atornillar forma E 6"



Tamaño	Longitud (mm)	Zanco tipo	Empaque piezas	No. Parte
Ph1	150	MZ	1	B-57831
Ph2	150	MZ	1	B-57847
Ph3	150	MZ	1	B-57853
Sq1	150	MZ	1	B-57869
Sq3	150	MZ	1	B-57881
Pz1	150	MZ	1	B-59944
Pz2	150	MZ	1	B-59950
Pz3	150	MZ	1	B-59966
T15	150	MZ	1	B-59972
T20	150	MZ	1	B-59988
T25	150	MZ	1	B-59994
T30	150	MZ	1	B-60006

Punta especial Phillips Ph0x4"



Tamaño	Empaque piezas	No. Parte
6mm	1	B-42575

Punta de torsión p/ atornillar



Tamaño	Longitud (mm)	Zanco tipo	Empaque piezas	No. Parte
PH 2	100	MZ	1	B-56948
PZ 2	100	MZ	1	B-56954

Punta doble torsión Forma "D"



NUEVO

Tamaño	Longitud (mm)	Zanco tipo	Empaque piezas	No. Parte	
+	Ph 1	65	MZ	10	D-65523
+	Ph 1	65	MZ	100	D-65517

Punta doble torsión Forma "C" PH2-SL5



NUEVO

Tamaño	Longitud (mm)	Zanco tipo	Empaque piezas	No. Parte	
	Ph2-SL5	65	MZ	10	D-65545
	Ph2-SL5	110	MZ	10	D-65551
	Ph2-SL5	65	MZ	100	D-65539

Punta para atornillar doble "alta torsión"



Con magnético



* Japanese Package

	Tamaño	Longitud (mm)	Zanco tipo	Empaque piezas	No. parte
+	Ph 2	65	NZ-C	3	A-49563 *
	Ph 2	85	NZ-C	3	A-49585 *
	Ph 2	110	NZ-C	3	A-49600 *
	Ph 2	150	NZ-C	3	A-50120 *
	Ph2 (Slim)	65	NZ-C	3	A-50924 *
	Ph 1	65	MZ-C	3	B-21836
	Ph 1	85	MZ-C	3	B-21842
	Ph 1	110	MZ-C	3	B-21858
	Ph 2	85	MZ-C	3	B-12326
	Ph 2	110	MZ-C	3	B-21864
	Ph 3	65	MZ-C	3	B-21870
	Ph 3	85	MZ-C	3	B-21886
	Ph 3	110	MZ-C	3	B-21892
	Pz 1	65	MZ-C	3	B-21901
	Pz 1	85	MZ-C	3	B-21917
*	Pz 1	110	MZ-C	3	B-21923
	Pz 2	65	MZ-C	3	B-20719
	Pz 2	85	MZ-C	3	B-12790
	Pz 2	110	MZ-C	3	B-21939
	Pz 3	65	MZ-C	3	B-20725
	Pz 3	85	MZ-C	3	B-20731
	Pz 3	110	MZ-C	3	B-21945

Punta para atornillar doble "alta torsión"



Tamaño	Longitud	Zanco tipo	Empaque piezas	No. parte	
	Sq1	2-1/2" (65mm)	MZ-C	3	B-20884
	Sq1	3-3/8" (85mm)	MZ-C	3	B-20890
	Sq1	4-3/8" (110mm)	MZ-C	3	B-20909
	Sq2	2-1/2" (65mm)	MZ-C	3	B-20915
	Sq2	3-3/8" (85mm)	MZ-C	3	B-20921
	Sq2	4-3/8" (110mm)	MZ-C	3	B-20937
	Sq3	2-1/2" (65mm)	MZ-C	3	B-20943
	Sq3	3-3/8" (85mm)	MZ-C	3	B-20959
	Sq3	4-3/8" (110mm)	MZ-C	3	B-20965

Punta para atornillar "alta torsión"

Con magnético



Tamaño	Longitud	Zanco tipo	Empaque piezas	No. parte	
	1	1"	MZ-C	1	784217-A
	1	2-3/4"	MZ-C	1	784607-A
	1	6"	MZ-C	1	784610-A
	2	6"	MZ-C	1	784611-A
	3	6"	MZ-C	1	784612-A

Punta para atornillar

Empaque (forma-C)



Tamaño	Longitud (mm)	Zanco tipo	Empaque piezas	No. Parte	
	Ph1,Ph2,Ph3	25	A	3	B-24511
	Pz1,Pz2,Pz3	25	A	3	B-24527
	T20,T25,T30	25	A	3	B-24533

Punta para atornillar

Empaque (forma-E)



Con magnético



Tamaño	Longitud (mm)	Zanco tipo	Empaque piezas	No. Parte	
	Ph1,Ph2,Ph3	50	1/4" Hex	3	B-26179
	Pz1,Pz2,Pz3	50	1/4" Hex	3	B-26185
	T20,T25,T30	50	1/4" Hex	3	B-26191

Punta plana para atornillar

Empaque (forma-E)



Con magnético

Tamaño	Longitud (mm)	Zanco tipo	Empaque piezas	No. Parte
SL	0.5x4.0 x 25mm	1/4" Hex	3	B-23519
SL	0.8x5.5 x 25mm	1/4" Hex	3	B-23531
SL	1.0x5.5 x 25mm	1/4" Hex	3	B-23547
SL	1.2x8.0 x 25mm	1/4" Hex	3	B-23569
SL	3-4 x 25mm	1/4" Hex	3	B-24181
SL	4-5 x 25mm	1/4" Hex	3	B-24197
SL	8-10 x 25mm	1/4" Hex	3	B-24228
SL	0.5x4.0 x 50mm	1/4" Hex	3	B-25286
SL	0.8x5.5 x 50mm	1/4" Hex	3	B-25301
SL	1.0x5.5 x 50mm	1/4" Hex	3	B-25317
SL	3-4 x 50mm	1/4" Hex	3	B-25878
SL	4-5 x 50mm	1/4" Hex	3	B-25884
SL	8-10 x 50mm	1/4" Hex	3	B-25915

Puntas para atornillar Caja flip top Forma-C



Tamaño	Longitud (mm)	Zanco tipo	Empaque piezas	No. Parte	
	Pz1	25	A	25	B-24608
	Pz2	25	A	25	B-24614
	Pz3	25	A	25	B-24620
	T15	25	A	25	B-24636
	T20	25	A	25	B-24642
	T25	25	A	25	B-24658
	T30	25	A	25	B-24664

Puntas para atornillar Caja flip top (forma-E)



Con magnético

Tamaño	Longitud (mm)	Zanco tipo	Empaque piezas	No. Parte	
	Pz1	50	MZ-B	10	B-26266
	Pz2	50	MZ-B	10	B-26272
	Pz3	50	MZ-B	10	B-26288

Puntas para atornillar Caja flip top (forma-E)



Con magnético



Tamaño	Longitud (mm)	Zanco tipo	Empaque piezas	No. Parte	
	T15	50	MZ-B	10	B-26294
	T20	50	MZ-B	10	B-26303
	T25	50	MZ-B	10	B-26319
	T30	50	MZ-B	10	B-26325

Puntas para atornillar Minivitolero (forma-C)



Tamaño	Longitud (mm)	Zanco tipo	Empaque piezas	No. Parte	
	Ph2	25	A	100	B-24876
	Sq2	25	A	100	B-24898

Puntas para atornillar Minivitolero (forma-E)



Con magnético



Tamaño	Longitud (mm)	Zanco tipo	Empaque piezas	No. Parte	
	Ph2	50	MZ-B	50	B-26490
	Sq2	50	MZ-B	50	B-26515

Puntas phillips 1" para atornillar Vitrolero



Tamaño	Longitud (mm)	Zanco tipo	Empaque piezas	No. Parte	
	PH2	25	Forma C	250	B-62452
	PH2	50	Forma E (MZ)	100	B-62468

Bolsa de plástico (forma-C)



Tamaño	Longitud (mm)	Zanco tipo	Empaque piezas	No. Parte	
	Ph2	25	A	100	B-24957
	Sq2	25	A	100	B-24979

Bolsa de plástico (forma-E)



Con magnético



Tamaño	Longitud (mm)	Zanco tipo	Empaque piezas	No. Parte	
	Ph2	50	MZ-B	50	B-26571
	Sq2	50	MZ-B	50	B-26593

Caja flip top tipo Phillips(forma C)



Tamaño	Longitud (mm)	Tipo	Empaque piezas	No. Parte	
	Ph1X1"	25	MZ-B	25	B-24577
	Ph2X1"	25	MZ-B	25	B-24583
	Ph3X1"	25	MZ-B	25	B-24599
	Ph1X2"	50	MZ-B	10	B-26238
	Ph2X2"	50	MZ-B	10	B-26244
	Ph3X2"	50	MZ-B	10	B-26250
	Phillips doble #2 2-9/16"	65	NZ-C	100	D-31669
	Ph2x1"	25	NZ-C	250	784211A250
	Ph2x1"	25	NZ-C	250	784312A250

Set de puntas de ajuste para atornilladores y atornilladores de impacto

Quando utilice una punta para atornillar o punta socket, revise sus dimensiones (A) o (B). Cuando sus dimensiones de 11mm y 9.5mm respectivamente, instale esta punta en su herramienta.

No. Parte **322279-6**

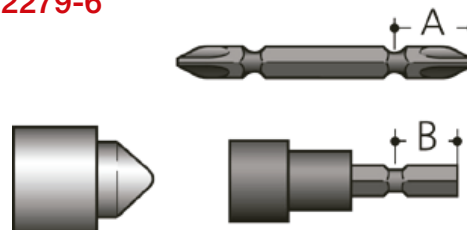

Accesorios para atornilladores

Boquillas para atornillador de tablaroca



Usar en	Boquilla tipo	Medida	Empaque piezas	No. Parte
6801DBV	Boquilla de tope	1/4"	1	411292-0
6802BV	Boquilla de tope	3/8"	1	122212-6
6802BV	Boquilla de tope	5/16"	1	122213-4
6820V	Boquilla de tope	3/8"	1	122450-0
6827	Tapa frontal de dado	3/8"	1	322119-8
6827	Tapa frontal de dado	5/16"	1	322125-3
6827	Tapa frontal de dado	1/4"	1	322124-5
6827	Tapa frontal de dado	7/16"	1	322126-1
6827	Tapa frontal de dado	5/16"	1	322120-3
6826	Localizador	1/4"	1	152483-1

Eje flexible

Extensión flexible para atornillado en esquinas y en lugares de difícil acceso



Longitud	Tipo	No. Parte
12"	Eje flexible	B-51873

Adaptador magnético



Longitud	Zanco	Tipo	No. Parte
2 3/8"	1/4"	Adaptador magnético hexagonal tipo broquero	B-52473
2 3/8"	1/4"	Adaptador magnético	B-52451
6"	1/4"	Adaptador magnético	B-57750
12"	1/4"	Adaptador magnético	B-57766

Porta puntas (llavero)

Las puntas pueden ser reemplazadas fácilmente ya que con un solo movimiento se pueden desmontar y conectar nuevamente.



Zanco	Piezas por empaque	No. Parte
MZ 1/4"	1	B-54411

Puntas magnéticas (guías buscadoras)



Usar en	Tipo	Medida	Longitud	Empaque piezas	No. Parte
Todos los modelos de atornillador	Dado	7/16"	2-3/16"	1	784805-3
6826	Sujetador magnético	1/4"	2-3/16"	1	784811-8

Guía buscadora magnética

Vitrolero



NUEVO

Medida	Longitud	Empaque piezas	No. Parte
1/4"	50mm	50	E-01856
5/16"	50mm	50	E-01862
3/8"	50mm	50	E-01878

Puntas magnéticas (guías buscadoras) 1-7/8"

6,8,10,12,13mm (Para todos los modelos de atornillador)

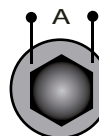

Medida: pulgadas

Medida	Longitud	Tipo	Empaque piezas	No. Parte
1/4"	1-7/8"	MZ	1	B-38794
5/16"	1-7/8"	MZ	1	B-38803
3/8"	1-7/8"	MZ	1	B-38819
7/16"	1-7/8"	MZ	1	B-38825
1/2"	1-7/8"	MZ	1	B-38831
1/4"	75mm	MZ	1	784801-1
1/4"	2-3/8"	MZ	1	784811-8

Puntas magnéticas (guías buscadoras) 2-9/16"



Medida	Longitud	Tipo	Empaque piezas	No. Parte
1/4"	2-9/16"	MZ	1	B-45076
5/16"	2-9/16"	MZ	1	B-45082
3/8"	2-9/16"	MZ	1	B-45098
7/16"	2-9/16"	MZ	1	B-45107

Guía buscadora transparente

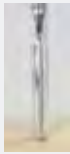
Descripción	Longitud	Empaque Piezas	No. Parte
	1/4"	4-3/4"	1 B-52940
Guía buscadora + Juego de puntas (25 piezas) Ph1-1"x5 Ph2-1"x5 Ph3-1"x5 S15-1"x5 S16-1"x5	3-1/8"	25	B-49890
Guía buscadora + Juego de puntas (25 piezas) Ph1-1"x5 Ph2-1"x5 Ph3-1"x5 S15-1"x5 S16-1"x5	4-3/4"	25	B-49909

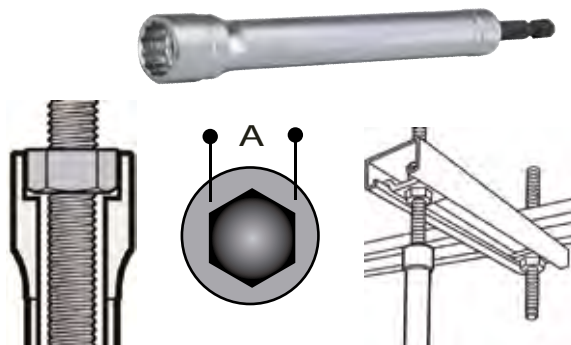

Guía buscadora hexagonal hueca para esparragos

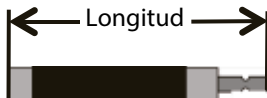

Tamaño socket	Longitud	Zanco tipo	No. Parte
7/16"	3"	MZ	B-50784
7/16"	6"	MZ	B-50790
7/16"	12"	MZ	B-50809
7/16"	18"	MZ	B-50815
7/16"	24"	MZ	B-50821
15/16"	3"	MZ	B-50837
15/16"	6"	MZ	B-50843
15/16"	12"	MZ	B-50859
15/16"	18"	MZ	B-50865
15/16"	24"	MZ	B-50871
9/16"	3"	MZ	B-43290
9/16"	6"	MZ	B-43309
9/16"	12"	MZ	B-43315
9/16"	18"	MZ	B-43321
9/16"	24"	MZ	B-43337
3/4"	3"	MZ	B-43343
3/4"	6"	MZ	B-43359
3/4"	12"	MZ	B-43365
3/4"	18"	MZ	B-43371
3/4"	24"	MZ	B-43387

Guía buscadora



Descripción	Longitud	Empaque Piezas	No. Parte
	3-1/8"	1	B-48795
	4-3/4"	1	B-48804
Guía buscadora + Juego de puntas (25 piezas) Ph2-1"x10, Sq2-1"x10, Sl8-10-1"x5	3-1/8"	25	B-48810
Guía buscadora + Juego de puntas (25 piezas) Ph2-1"x10, Sq2-1"x10, Sl8-10-1"x5	4-3/4"	25	B-48826

Guía de atornillado 30mm con punta PH2



Contiene	Forma	Piezas por empaque	No. Parte
Guía de 30mm con punta PH2 para tablaroca	C	1	D-61709
Guía de 40mm con punta PH2 para tablaroca	E	1	B-60399

Socket fijador de varilla roscada



Tamaño	Empaque piezas	No. Parte
6mm	1	B-42961
8mm	1	B-42977
10mm	1	B-42983
3/8"	1	B-51611
1/2"	1	B-51627

Juegos de puntas para atornillar 7 piezas



NUEVO

Contenido		No. Parte
+	Ph1, Ph2 x 25mm	D-73271
+	Pz2, Pz3 x 25mm	
●	SL3, SL5 x 25mm	
	Dado magnético	

Juegos de puntas para atornillar con soporte de goma 10 piezas



NUEVO

Contenido	Longitud	Zanco	No. Parte
+	50mm	E-form	D-65028
+			
●			
⊕			

Juegos de puntas para atornillar con adaptador 11 piezas



NUEVO

Contenido	Zanco	No. Parte
+	E-form	D-65006
+		
●		
⊕		

Juego de puntas para atornillar con dado magnético (MZ) 12 piezas



Contenido	No. Parte
+	D-31083
⊕	D-31083-12 Empaque con 12 juegos
⊕	

Juego de puntas tipo T, 2" de longitud 18 piezas



Contenido		No. Parte
+	Ph1, 2xPh2, Ph3 x 25mm	B-28896
+	Ph1, Ph2, Ph3 x 50mm	
●	SL4, SL5, SL6 x 50mm	
+	Ph2, 2x1", Pzs 8	B-43000
+	Ph2, 2x2", Pz 3	
●	Pz3, 3x2", Pz 1	
●	SL 4, 5, 6 Pzs 1	Adaptador hexagonal pzs. 1

Juegos de puntas para atornillar con dado magnético (MZ) 28 Piezas



Contenido	Zanco	No. Parte
+	MZ	B-28911
+		
●		
⊕		
○		

Juegos de puntas para atornillar con dado magnético (MZ) 28 Piezas



Contenido	Zanco	No. Parte
+	Forma C Forma E	B-40347
●		
⊕	MZ	
⊕		

Estuche tipo batería con puntas para atornillar 31 piezas



NUEVO

Contenido	Longitud	Zanco	No. Parte
<ul style="list-style-type: none"> PH0, PH1, 4xPH2, PH3 Pz0, Pz1, 4xPz2, Pz3 SL0.6x4.5, SL0.8x5.5, SL1.2x6.5 T10, T15, 2xT20, 2xT25, T27, T30, T40 Hex3, Hex4, Hex5, Hex6 	25mm	C-form	* E-00022 Empaque con 12 juegos
Adaptador para dado	60mm	1/4" Hex (E-form MZ)	

Juego de puntas para atornillar con adaptador 32 piezas



NUEVO

Incluye adaptado para dados para fácil instalación de tornillos y tuercas

Contenido	Largo	Zanco	No. Parte
<ul style="list-style-type: none"> PH0, PH1x2, PH2x4, PH3x2 PZ1x2, PZ2x3, PZ3 SL4, SL6 T10, T15, T20x2, T25x2, T27, T30, T40 H3, H4, H5, H6 	25mm	Forma C	D-65084
Adaptador para dado 1/2"	50mm	Forma E (MZ)	
Adaptador para dado tipo broquero 1/4"	60mm		

Juegos de puntas phillips

Para todos los modelos de atornilladores inalámbricos



Tamaño	Longitud	Empaque piezas	No. Parte
+	#2	4-5/16"	Pack 10 Pzs. D-34849
+	#2	2-9/16"	Pack 10 Pzs. D-34366

Juegos puntas magnéticas Estuche con 43 piezas

Organizadas por colores para identificarlas más fácilmente



Contiene	Longitud	Zanco	Piezas por empaque	No. Parte
PH1, PH2x2, PH3 PZ1, PZ2x2, PZ3 SL 3, SL 4, SL 4.5, SL 5.5 H3, H4, H5, H6 T10, T15x2, T20x2, T25, T27, T30, T40 TH10, TH15, TH20, TH25, TH27, TH30, TH40	25mm	1/4" Hex Forma C	43	B-55697
PH2 / PZ2 / SL 4.5 / T15, T20, T25	75mm	1/4" Hex MZ		
Adaptador magnético	60mm			
Guía buscadora	80mm			
Dados magnéticos 6mm, 8mm, 10mm	50mm			

Juego de Autoclear con matraca y 20 accesorios



Contenido	Empaque piezas	No. Parte
Puntas para atornillar 25mm, zanco Hex 1/4" PH1, PH2, PH3, PZ1, PZ2, T20, T25, T30, HEX4, HEX6, SL 0.8x5.5, SL 1.2x6.5 (1 pza. c/u) Adaptador de cuadro 1/4", 60mm (1 pza.) Porta puntas magnético 60mm, zanco Hex 1/4" (1 pza.) Minillave de matraca 100mm (1 pza.) Dados 5.0, 6.0, 8.0, 10.0, 12.0, 13.0 (1 pza c/u)	21	B-54081

Juego de puntas para atornillar con avellanador 29 piezas

No. Parte **D-73477**

NUEVO



Contenido	Empaque piezas	No. Parte
Puntas para atornillar 25mm, zanco C-form PH0, PH1, PH2, PH3, SL3, SL4, SL5, SL6, HEX3, HEX4, HEX5, HEX6, T10, T15, T20, T25	1 PZ C/U	29 D-73477
Puntas para atornillar 25mm, zanco C-form PZ0, PZ1, PZ2, PZ3	2 PZS C/U	
Adaptador magnético 1/4" Hex Avellanador con punta de 25mm No. 6 Avellanador con punta de 25mm No. 8 Avellanador con punta de 25mm No. 10 Repuesto del avellanador	1 PZ C/U	

Juego de puntas para atornillar con avellanador

47 piezas

No. Parte **D-73461**

NUEVO

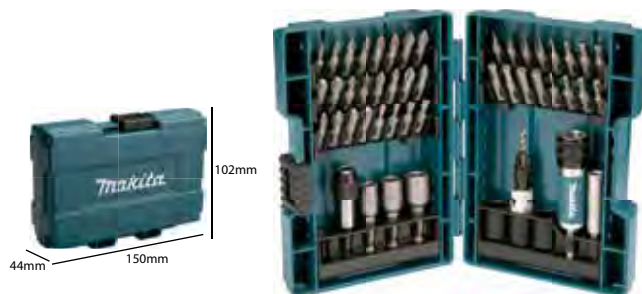

Contenido	Empaque piezas	No. Parte
Puntas para atornillar 25mm, zanco C-form PH0 (x2), PH1(x2), PH2 (x4), PH3 (x2),SL3 (x2), SL4 (x2), SL5 (x2), SL6 (x2), HEX3 (x2), HEX4 (x2), HEX5 (x2), HEX6 (x2), PZ0 (x2), PZ1 (x2), PZ2 (x4), PZ3 (x2), T10 (x1), T15 (x1), T20 (x1), T25 (x1)	47	D-73461
Dado magnético 6mm x 48mm 1/4" Hex Dado magnético 8mm x 48mm 1/4" Hex Dado magnético 10mm x 48mm 1/4" Hex Adaptador magnético 1/4" Hex Adaptador con zanco tipo broquero Avellanador con punta de 25mm No. 8 Repuesto del avellanador		

Juego de puntas para atornillar con avellanador

32 piezas

No. Parte **E-11944**

NUEVO

Ideal para usuarios de bricolaje, fabricantes de muebles, carpinteros, Mantenimiento de equipos eléctricos, trabajadores de la construcción, etc.

Bandeja con imán
Se puede separar para colocarla cerca del área de trabajo



Contenido	Longitud	No. Parte
<ul style="list-style-type: none"> ⊕ Ph1 (x2), Ph2 (x5), Ph3 (x2) ● SL4 (x1), SL6 (x1), SL7 (x1) ⊕ T10 (x1), T15(x1), T20 (x1), T25 (x1), T30 (x1), T40(x1) ○ SQ1 (x2), SQ2 (x4), SQ3 (x3) 	1"	E-11944
Portapuntas magnético (x1)	2-1/4"	
Guía buscadora (x1)	3-1/8"	
Adaptador cuadro 1/4"	2"	
Guía buscadora magnética 1/4"	2"	
Guía buscadora magnética 5/16"	2"	
Bandeja con imán		

Juego de puntas para atornillar con adaptador tipo broquero

32 piezas

No. Parte **D-74762-12**

NUEVO



Contenido	Largo	Zanco	No. Parte
<ul style="list-style-type: none"> ⊕ PH1 (x2), PH2 (x4), PH3 (x1) ⊕ PZ1 (x2), PZ2 (x5), PZ3 (x1) ● SL4 (x1), SL5.5 (x1), SL6.5 (x1) ⊕ T10 (x2), T15(x2), T20 (x2), T25 (x3), T30 (x2), T40 (x1) 	25mm	Forma C	D-74762-12
Mandril 1/4"	60mm	Forma E (MZ)	
Adaptador para dado tipo broquero 1/4"	25mm		

Juego de puntas para atornillar con avellanador

50 piezas

Ideal para usuarios de bricolaje, fabricantes de muebles, carpinteros, Mantenimiento de equipos eléctricos, trabajadores de la construcción, etc.

No. Parte **E-11950**

NUEVO



Contenido	Longitud	No. Parte
<ul style="list-style-type: none"> ⊕ Ph1 (x2), Ph2 (x4), Ph3 (x2) ● SL4 (x1), SL6 (x1), SL7 (x1) ⊕ T10 (x1), T15(x1), T20 (x1), T25 (x1), T30 (x1), T40(x1) ○ SQ1 (x2), SQ2 (x4), SQ3 (x2) ⊕ PZ1 (x1), PZ2 (x1), PZ3 (x1) ○ Hex4 (x1), Hex5 (x1), Hex6 (x1), Hex7 (x1) 	1"	E-11950
<ul style="list-style-type: none"> ○ SQ1 (x1), SQ2 (x1), SQ3 (x1) ⊕ Ph1 (x1), Ph2 (x1), Ph3 (x1) 	2"	
<ul style="list-style-type: none"> ○ SQ1 (x1), SQ2 (x1), SQ3 (x1) 	3-1/2"	
Portapuntas magnético (x1)	2-1/4"	
Adaptador cuadro 1/4"	2"	
Guía buscadora magnética 1/4"	2"	
Guía buscadora magnética 5/16"	2"	
Guía buscadora magnética 3/8"	2"	
	1/16"	
	1/8"	
Broca HSS-Tin para metal Zanco Hex 1/4"	3/16"	
	1/4"	

El equipo estándar (accesorios), las especificaciones y las fotografías pueden variar. Los accesorios pueden no estar incluidos desde origen con las herramientas, aunque se indiquen en este catálogo.

Juego de puntas para atornillar con avellanador

60 piezas

Ideal para usuarios de bricolaje, fabricantes de muebles, carpinteros, mantenimiento de equipos eléctricos, trabajadores de la construcción, etc.

NUEVO

No. Parte **E-11966**



Contenido	Longitud	No. Parte
<ul style="list-style-type: none"> ⊕ Ph0 (x2), Ph1 (x2), Ph2 (x6), Ph3 (x2) ⊕ SL4 (x2), SL6 (x2), SL7 (x2) ⊕ T10 (x2), T15(x2), T20 (x2), T25 (x2), T30 (x2), T40(x2) ⊕ SQ1 (x2), SQ2 (x6), SQ3 (x2) ⊕ PZ1 (x2), PZ2 (x2), PZ3 (x2) ⊕ Hex3 (x2), Hex4 (x2), Hex5 (x2), Hex6 (x2), Hex7 (x2) 	1"	E-11966
<ul style="list-style-type: none"> ⊕ SQ2 (x1) ⊕ Ph2 (x1) 	3-1/2"	
Guía buscadora	3-1/8"	
Adaptador tipo broquero		

Juego de dados de impacto con recubrimiento plástico

Para cambio de neumáticos

E-12354

NUEVO

Fabricados en Cromo Molibdeno



Cuadro de 1/2"

Azul
17x86mm

Amarillo
19x86mm

Rojo
21x86mm

Diferentes colores para fácil identificación del tamaño

Con **Recubrimiento plástico** (externo e interno) que ayuda a proteger el Birlo y el neumático



Empaque con 3 pzs



Incluye bolsa textil para almacenamiento y fácil transporte

Juegos de dados magnéticos



Descripción	Piezas por empaque	No. Parte
Tipo dado: 1/4" , 5/16" , 3/8"	3	B-38847
Tipo dado: 1/4" , 5/16" , 3/8" , 7/16"	4	B-38853

Dados magnéticos

Para usar con adaptador con zanco SDS PLUS B-59259

NUEVO

Diámetro	Longitud	No. Parte
5/16" 7/16"	3/8" 1/2"	1 - 7/8" B-59265



Dados con cuadro de 1/2"

Diámetro	Longitud	No. Parte
3/8"	3-3/16"	A-96235
7/16"	3-3/16"	A-96241
1/2"	3-3/16"	A-96257
9/16"	3-3/16"	A-96263
5/8"	3-3/16"	A-96279
11/16"	3-3/16"	A-96285
3/4"	3-3/16"	A-96291
13/16"	3-3/16"	A-96300
7/8"	3-3/16"	A-96316
15/16"	3-3/16"	A-96322
1"	3-3/16"	A-96338
1-1/16"	3-3/16"	A-96344
1-1/8"	3-3/16"	A-96350
1-1/4"	3-3/16"	A-96366
1-3/16"	3-3/16"	A-96394



Juego de dados de impacto con cuadro de 1/4"x2" y adaptador de 1/4" Hex (9pzs)

No. Parte **E-12289**

Base flexible para fácil transporte



NUEVO

Cuadro	Longitud (mm)	No. Parte
1/4"	6mm, 7mm, 8mm, 10mm, 11mm, 12mm, 13mm x 23mm	E-12289

Adaptador con cuadro de 1/4" para llave de impacto

NUEVO

Cuadro	Zanco	Longitud	No. Parte
1/4"	1/4" Hex.	50mm	D-74740

Juego de dados de impacto con cuadro de 3/8" y adaptador 1/4" Hex. (9pzs)

NUEVO



Diámetro	Longitud (mm)	No. Parte
3/8"	8mm, 10mm, 12mm, 13mm, 14mm, 15mm, 17mm, 18mm	B-54651

Adaptador con zanco SDS Plus (tipo broquero) para toda la gama de rotomartillos SDS- Plus

NUEVO



Zanco	Longitud	No. Parte
SDS Plus	3 - 1/8"	B-59259

Adaptador con cuadro de 3/8" para llave de impacto

NUEVO



* Para DTW800

Cuadro	Zanco	Longitud	No. Parte
3/8"	1/4" Hex.		B-54667
3/8"	1/4" Hex.	150mm (6")	B-57738
3/8"	7/16" Hex.		B-59835 *

Juego de dados de impacto con cuadro de 1/2" y adaptador 1/4" Hex. (9pzs)

NUEVO



Diámetro	Longitud (mm)	No. Parte
1/2"	8mm, 10mm, 12mm, 13mm, 14mm, 15mm, 17mm, 18mm	B-54645

Adaptador con cuadro de 1/2" para llave de impacto

NUEVO



* Para DTW800

Cuadro	Zanco	Longitud	No. Parte
1/2"	1/4" Hex. (MZ)		B-54673
1/2"	1/4" Hex.	150mm (6")	B-57744
1/2"	7/16" Hex.	150mm (6")	B-59841 *

Adaptador zanco 1/4" Hex para llave de impacto

NUEVO



Zanco	Descripción	No. Parte
1/4"	Adaptador con cuadro 1/2" a 1/4" Hex	B-68448
1/4"	Adaptador con cuadro 3/8" a 1/4" Hex	B-68454

Extensión con cuadro de 1/2"
para llave de impacto

NUEVO



Cuadro	Zanco	Longitud	No. Parte
1/2"	1/4" Hex.	10"	B-55734
1/2"	1/4" Hex.	6"	B-55740
1/2"	1/4" Hex.	3"	B-55756

Juego de dados con cuadro de 3/8"
Estuche con 14 piezas

NUEVO



Juego de dados con cuadro de 1/2"
Estuche con 9 piezas

NUEVO



Medida: milímetros

Hexágono	Longitud	No. Parte
8mm	38mm	B-66232
10mm	38mm	
12mm	38mm	
13mm	38mm	
14mm	38mm	
16mm	38mm	
17mm	38mm	
19mm	38mm	
21mm	38mm	

Medida: Pulgadas

Hexágono	Longitud	No. Parte
1/4"	3/8"	A-99655
5/16"	3/8"	
11/32"	3/8"	
3/8"	3/8"	
7/16"	3/8"	
1/2"	3/8"	
9/16"	3/8"	
5/8"	3/8"	
11/16"	3/8"	
3/4"	3/8"	
13/16"	3/8"	
7/8"	3/8"	
15/16"	3/8"	
1"	3/8"	

Dados con cuadro de 3/8"

NUEVO



Medida: Pulgadas

Hexágono	Longitud	No. Parte
1/4"	2-1/2"	A-99518
5/16"	2-1/2"	A-99524
11/32"	2-1/2"	A-99530
3/8"	2-1/2"	A-99546
7/16"	2-1/2"	A-99552
1/2"	2-1/2"	A-99568
9/16"	2-1/2"	A-99574
5/8"	2-1/2"	A-99580
11/16"	2-1/2"	A-99596
3/4"	2-1/2"	A-99605
13/16"	2-1/2"	A-99611
7/8"	2-1/2"	A-99627
15/16"	2-1/2"	A-99633
1"	2-1/2"	A-99649



DADOS INTERNOS Y EXTERNOS Para degolladoras

6922NB

Dados internos

	Usar en	Tipo	Diámetro	Longitud mm	Empaque Pieza	No. Parte
	6922NB	Interno	5/8" M16	36mm	1	764416-0
	6922NB	Interno	7/8" M22	39mm	1	764418-6
	6922NB	Interno	7/8" M22	85mm	1	764352-0
	6922NB	Interno	3/4"	38mm	1	764419-4
	6922NB	Interno	5/8"	36mm	1	764420-9
		Interno	3/4"	84mm	1	764353-8

Dados externos

	Usar en	Tipo	Diámetro	Longitud mm	Empaque pieza	No. Parte
	6922NB	Externo	7/8" M22	85mm	1	764364-3
	6922NB	Externo	M16	35mm	1	764362-7
	6922NB	Externo	M20	37mm	1	764361-9
	6922NB	Externo	7/8" M22	39mm	1	153909-6
	6922NB	Externo	M20	83mm	1	764363-5

6924NB

Dados internos

	Usar en	Tipo	Diámetro	Longitud	Empaque Pieza	No. Parte
	6924N	Interno	1"	49mm	1	194312-2
	6924N	Interno	M22	48mm	1	194310-6
	6924N	Interno	M24	49mm	1	194311-4

Dados externos

	Usar en	Tipo	Diámetro	Longitud	Empaque pieza	No. Parte
	6924NB	Externo	M22	49mm	1	194033-6
	6924N	Externo	7/8"	49mm	1	194092-0
	6924N	Externo	M24	49mm	1	194034-4
	6924N	Externo	7/8"	136mm	1	764382-1
	6924N	Externo	7/8"	226mm	1	764383-9
	6924N	Externo	1"	136mm	1	764380-5
	6924N	Externo	1"	226mm	1	764381-3

El equipo estándar (accesorios), las especificaciones y las fotografías pueden variar. Los accesorios pueden no estar incluidos desde origen con las herramientas, aunque se indiquen en este catálogo.

DADOS INTERNOS Y EXTERNOS

Combinaciones

6922NB

Dados internos





No. Parte	Descripción
 764416-0	Dado interno completo M16, 36mm
 764419-4	Dado interno completo 3/4" 38mm
 764352-0	Dado interno M22, 7/8", 85mm
 764353-8	Dado interno completo 3/4", 84mm
 764420-9	Dado interno 36mm
 764418-6	Dado interno 7/8" M22, 39mm

Dados externos

No. Parte	Descripción
 764362-7	Dado externo M16, 35mm
 764361-9	Dado externo 37mm
 764364-3	Dado externo 85mm
 764363-5	Dado externo 3/4", 83mm
 764362-7	Dado externo 5/8" 35mm
 153909-6	Dado externo M22, 7/8", 39mm

6924NB

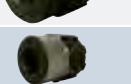
Dados internos

No. Parte	Descripción
 194310-6	Dado interno completo M22, 48mm
 194312-2	Dado interno completo, 1", 49mm
 194310-6	Dado interno completo M22, 49mm
 194311-4	Dado interno completo M24, 49mm
 194312-2	Dado interno completo M22, 1"
 194310-6	Dado interno completo M22, 7/8"
 194310-6	Dado interno completo M22, 7/8"

Dados externos

No. Parte	Descripción
 194033-6	Dado externo completo M22, 49mm
 194034-4	Dado externo completo 1", 49mm
 194092-0	Dado externo completo 7/8", 49mm
 194034-4	Dado externo completo, 1", 49mm
 764383-9	Dado externo 7/8" -226
 764380-5	Dado externo 1-136
 764381-3	Dado externo 1-226



SET DE BROCAS Y PUNTAS



HIELERA TIPO MAKPACK

Para fácil transporte de bebidas frías, alimentos, etc.



Se puede apilar
con el resto de los
estuches Makpack

Aislamiento térmico de
20mm de espesor



Incluye correa para facilitar
el transporte



* Incluye correa

11L

198306-9 (Tipo 3)



Capacidad

Puede almacenar hasta
10 botellas de PET
horizontalmente

Características	Código
	198306-9 TIPO 3
Dimensiones (L x A x A)	295 x 395 x 210mm 11-5/8" x 15-1/2" x 8-1/4"
Peso	2.9kg (6.3 lbs)
Capacidad	11 lts (mediana)



198306-9

ESTUCHES MAKIPAC

Innovador diseño de estuches apilables para una eficiente organización

1 Organización de Herramientas de trabajo

El innovador diseño de Makpac permite organizar, transportar y proteger herramientas y accesorios de trabajo.

2 Asa ergonómica

Asa corta y redondeada para mejor transporte y confort del usuario.



Carrito transportador de Makpac

Para apilar y transportar fácilmente los estuches con herramienta

No. Parte
TR00000002



3 Tapa y ranuras

Tapa reforzada que proporciona durabilidad adicional, además de ranuras a lo largo del estuche que otorga estabilidad al apilar varios estuches.

4 Broches a presión

Los broches a presión permiten cerrar bien el estuche, así como unir dos o más de estos y transportarlos fácilmente.



**Estuche Makpac
197210-9**

Tamaño Pequeño
Dimensiones internas:
3"-15-1/4"x11-1/4"
Dimensiones externas:
4-3/8"x15-1/2"x11-5/8"
Peso: 1.3kg



**Estuche Makpac
197211-7**

Tamaño Mediano
Dimensiones internas:
5-1/8"x15-1/4"x11-1/4"
Dimensiones externas:
6-1/2"x15-1/2"x11-5/8"
Peso: 1.6kg



**Estuche Makpac
197212-5**

Tamaño Grande
Dimensiones internas:
7-1/4"x15-1/4"x11-1/4"
Dimensiones externas:
8-1/2"x15-1/2"x11-5/8"
Peso: 1.9kg



**Estuche Makpac
197213-3**

Tamaño Extra-grande
Dimensiones internas:
11-1/4"x15-1/4"x11-1/4"
Dimensiones externas:
12-1/2"x15-1/2"x11-5/8"
Peso: 2.4kg



CARRITO TRANSPORTADOR DE ESTUCHES MAKPAK

Ideal para transportar estuches Makpac

No parte:
TR0000002

Cuerpo de aluminio
que le brinda mayor resistencia



Correas integradas que permiten transportar con seguridad la mercancía

Botón para liberar o plegar el mango

Base plegable



Peso máximo
Superficies planas: 125Kg
Escaleras: 60Kg
Excelente maniobrabilidad

Topes de Sujeción (laterales y frontal)
Brindan mayor sujeción de los estuches Makpac



Encuentra el complemento ideal para tus estuches Macpak

Charola multiusos	Carrito Macpak	Almohadillas de Hule espuma			
A-60551	A-60632	A-60595	A-60604	Tapas superiores	
Estuche para accesorios	Ideal para transporte de estuches	30mm de espesor	50mm de espesor	A-60573	A-60567
					

*Compatible solo con Macpak tipo 1

Hieleras CW001G / DCW180



Mantiene el frío ó el calor



CW001G

DCW180

Capacidad de enfriamiento

-18°C ~ 10°C

Capacidad de calentamiento

30°C ~ 60°C CW001G
55°C ~ 60°C DCW180

Ajustes de temperatura interior más detallados

	Enfriamiento						Calentamiento							
°C	-18	-15	-10	-5	0	5	10	30	35	40	45	50	55	60
°F	0	5	15	25	30	40	50	85	95	105	115	120	130	140

CW001G / DCW180

CW001G

DCW180



Asa para el transporte



Display LED



Árnes para el hombro

Compatible con 3 fuentes de energía DCW180 / CW001G



Baterías 18V LXT



Adaptador AC (corriente alterna)



12V/24V DC (toma de cigarrillos)



IPX4 resistencia al agua
Cuando esta funcionando con batería



Puerto USB
Tipo A para DC5V / 2.4A



Destapador
Para abrir botellas con corcholata

¡Llévala a cualquier lugar!

Ideal para el camping, la playa, las comidas en el parque, el bosque, etc...

Para hielera CW001G



Baterías 40Vmax XGT (1 ó 2 baterías)



También se puede alimentar con la combinación de una batería XGT y una batería LXT



CW001G



DCW180

Hielera inalámbrica CW001GZ01 / DCW180Z

Capacidad	20L (5.3gal)
Sistema de enfriamiento	Tipo compresor
Capacidad de enfriamiento	-18 / -15 / -10 / -5 / 0 / 5 / 10°C (0 / 5 / 15 / 25 / 30 / 40 / 50°F)
Sistema de calentamiento	Calentador
Capacidad de calentamiento	CW001G: 30 / 35 / 40 / 45 / 50 / 55 / 60°C (85 / 95 / 105 / 115 / 120 / 130 / 140°F) DCW180: 55 / 60°C (130 / 140°F)
Dimensiones (LxAxA)	663x341x372 mm (26-1/8x13-3/8x14-5/8")
Peso neto	13.5 - 16.1 kg (29.8 - 35.5 lbs.)

• Árnes al hombro, adaptador AC de 2m, cable para conexión a toma de cigarrillos de 2.5m

Ninguno de los dos modelos incluyen cargador ni batería.

Juego de brocas y puntas

Para madera y metal
17 piezas

Contenido	No. Parte
Brocas y puntas varias medidas, varias longitudes	D-31762



Juego de accesorios multipropósito

Empaque con 17 piezas



Medidas en pulgadas tipo MZ

Contenido	Piezas	No. Parte
+ Ph2, Ph3 * T20, T25 * Pz2, Pz3 - SL 8.0, 1.2	8 pzs	D-45836
Broca HSS-R : 1/8", 3/16", 7/32", 1/4"	4 psz	
Broca para concreto: 3/16", 7/32", 1/4", 5/16"	4 psz	
Porta punta magnético	1 pz	

Juego de accesorios multipropósito

Empaque tipo tableta con 33 piezas



Contenido	No. Parte
+ Ph1, Ph2, Ph3 - SL 4.0, 6.0 * Pz1, Pz2	B-49389
Broca HSS-R : 2mm 3mm , 3.3mm , 4mm , 4.2mm , 5mm	
Broca para concreto: 4mm , 5mm , 6mm , 7mm , 8mm	
Broca para madera: 3mm , 4mm , 5mm , 6mm , 7mm , 8mm	
A tornillador	

Juego de accesorios multipropósito Metal, concreto, madera



Medidas en pulgadas tipo MZ

Contenido	No. Parte
Broca HSS-G : 4mm , 5mm , 6mm , 7mm , 8mm , 10mm Broca p/concret.o : 4mm , 5mm , 6mm , 7mm , 8mm , 10mm Broca p/madera : 4mm , 5mm , 6mm , 7mm , 8mm , 10mm	B-49432

Juego de accesorios multipropósito

Empaque con 34 piezas



Juego de accesorios multipropósito

Empaque con 30 piezas



Contenido	No. Parte
+ Ph1, Ph2, Ph3 - SL 4.0, 5.0 6.0 * Pz1, Pz2, Pz3 * T20, T25, T30 - H4, H6	D-47204
Broca HSS : 3mm , 4mm , 5mm , 6mm	
Broca para concreto: 4mm , 5mm , 6mm , 8mm	
Broca para madera: 4mm , 5mm , 6mm , 8mm	
Avellanador p/metal	
Sujetador magnético p/puntas	

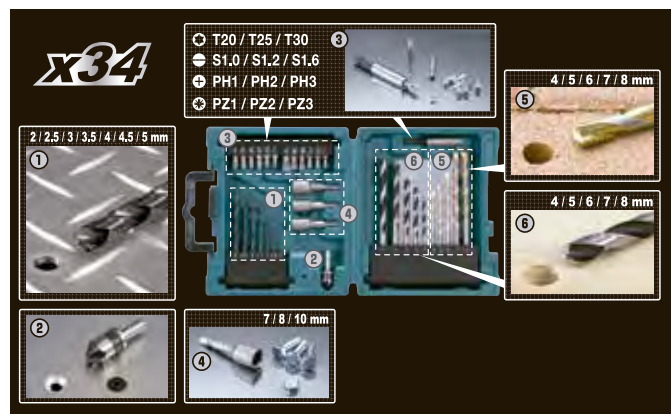

Medidas en pulgadas tipo MZ

Contenido	No. Parte
Broca HSS-R * T20, T25, T30 Broca p/concret.o - S 1.0, S1.2 S1.5 * PZ1, PZ2, PZ3 Broca p/madera - SL 4.0, 5.0 6.0 Avellanadores + PH1, PH2, PH3 Dado magnético * PZ1, PZ2, PZ3 Guía magnética + PH1, PH2, PH3	D-36980

Juego de accesorios multipropósito

Empaque con 42 piezas

No. Parte **D-58877**



Contenido

- Ph0, Ph1, Ph2, Ph3
 - Pz1, Pz2, Pz3
 - H3, H4, H5, H6
 - T10, T15, T20, T25, T27, T30, T40, T45
- Broca para metal entrada Hex. 1/4", 2.5", 3.0", 4.0", 5.0", 6.0"
 Punta plana 0.5x4.0 1pz.
 Punta plana 0.8x5.5 1pz.
 Punta plana 1.2x6.5
 Dados 5, 6, 7, 8, 10, 11, 13mm
 Dado magnético
 Adaptador para dados
 Porta puntas

Juego de accesorios

Brocas para metal, Dados, Puntas y adaptadores

Empaque con 43 piezas

No. Parte **E-11922**

NUEVO



Contenido

- Dados 1/4", 5/16", 3/8", 7/16", 1/2" (x1pz)
 Guía buscadora magnética 60mm (x1pz)
 Guía buscadora 80mm (x1pz)
 Puntas 25mm Zanco forma C: Ph1, Ph2, Ph3, Sq1, Sq2, Sq3 (x2pz)
 Puntas 50mm Zanco forma E: Ph1, Ph2, Ph3, Sq1, Sq2, Sq3 (x2pz)
 Brocas HSS de óxido negro con zanco 1/4" Hex:
 1/16" x 57mm, 5/64" x 60mm, 3/32" x 62mm, 7/64" x 65, 1/8" x 67mm, 9/64" x 70mm
 5/32" x 72mm, 3/16" x 76mm, 7/32" x 78mm, 1/4" x 85mm, 5/16" x 102mm, 3/8" x 118mm

Juego de accesorios multipropósito

Empaque con 50 piezas

No. Parte **D-42014**



Contenido

- Brocas HSS 1, 2, 2.5, 3, 3.5, 4, 4.5, 5, 5.5, 6, 6.5mm
 Brocas para concreto 4, 5, 6, 7, 8mm / Brocas para madera 4, 5, 6, 8, 10mm
 Brocas de manita 16, 22mm / Adaptador magnético
 Dados 7, 8, 10mm c/adaptador / Calibrador de brocas
 Cutter (con 2 cuchillas de repuesto)
- Ph1, Ph2 (x2), Ph3

Juego de accesorios multipropósito

Empaque con 66 piezas



Contenido

- Ph1 (x2), Ph2 (x8), Ph3 (x2)
- SL 6-8 SL 8-10 SL 10-12
- SQ1, SQ2 (x4), SQ3
- T10, T15, T20, T25, T27, T30, T40

Brocas HSS-G 1/8", 9/64", 5/32", 3/16", 1/4"
 Brocas para madera 1/8", 3/16", 1/4", 5/16", 3/8"
 Brocas de manita Zanco Hex. 3/8", 1/2", 5/8"
 Adaptador magnético
 Adaptador c/sujeción
 Caja flip top (10pz)
 Dados hexagonales

B-51661

Juego de accesorios multipropósito

Empaque con 71 piezas



Contenido

- Puntas Forma C
- Ph1 (x3), Ph2 (x12), Ph3 (x3)
 - SL 6-8 SL 8-10 (X2) SL 10-12
 - SQ1 (x3), SQ2 (x12), SQ3 (x3)
 - T15, T20, T25, T27, T30

Puntas Forma E

- Ph2 (x4)
- SQ1 (x2), SQ2 (x4)

Brocas HSS-R 1/16", 5/64", 3/32", 7/64", 1/8",
 9/64", 5/32", 3/16", 7/32", 1/4"
 Brocas de manita Zanco Hex. 1/4", 3/8", 1/2", 5/8", 3/4"
 Adaptador magnético

B-50273

Juego de accesorios multipropósito

Empaque con 71 piezas



Contenido	No. Parte
<ul style="list-style-type: none"> ○ H3, H4, H5, H6x1" ● SL 6 SL7x1" SL4, SL6x2" ⊕ PZ0, 1, 2, 3x1" / Pz1, Pz2, Pz3x2" ⊕ T10, T15, T20, T25, T40 x1" T20, T25x2" <p>Brocas HSS Brocas HSS-Co Brocas de manita Adaptador magnético Dados 4, 5, 6, 7, 8, 9, 10mm c/ adaptador Flexómetro 3m Calibrador de brocas, Avellanador, Tope de profundidad 1-10mm</p>	D-47145

Juego de accesorios multipropósito estuche transparente

Empaque con 75 piezas



NUEVO

Contenido	No. Parte
<p>Puntas</p> <ul style="list-style-type: none"> ⊕ Ph0 (x2), Ph1 (x2), Ph2 (x4), Ph3 (x2) ● SL1/8, SL9/64, SL5/32, SL3/16, SL1/4 ⊕ T10 (x2), T15 (x2), T20 (x2), T25, T27, T30, T40 ○ H1/8, H9/64, H5/32, H1/4 ○ SQ0 (x2), SQ1 (x2), SQ2 (x4), SQ3 (x2) <p>Brocas HSS-R p/metal 1/8", 9/64", 5/32", 11/64, 3/16", 13/64", 7/32", 15/64", 1/4"</p> <p>Brocas p/madera 5/32", 3/16", 1/4", 5/16, 3/8"</p> <p>Brocas HSS p/concreto 5/32", 3/16", 1/4", 5/16", 3/8"</p> <p>Adaptador magnético 1/4" x 2-3/8"</p> <p>Broca de manita 1/2", 5/8"</p> <p>Avellanador 1-7/16"</p> <p>Dados 1/4", 5/16, 3/8", 7/16"</p>	E-06943

Juego de accesorios multipropósito

Empaque con 75 piezas



Contenido	No. Parte
<p>Puntas Forma E - MZ</p> <ul style="list-style-type: none"> ⊕ Ph1, Ph2, Ph3 ⊕ T20, T25, T30, T40 ⊕ Pz1, Pz2, Pz3 ○ H3, H4, H5, H6 <p>Brocas HSS-TiN p/metal 1, 1.5, 2, 2.5, 3 (x2), 3.5, 4 (x2), 4.5 (x2), 5.5, 6, 6.5, 7, 7.5, 8</p> <p>Brocas p/madera 4mm, 5mm, 6mm, 8mm</p> <p>Brocas HSS p/concreto 4mm, 5mm, 6mm, 7mm, 8mm</p> <p>Adaptador magnético</p> <p>Punzón 1/32"</p> <p>Avellanador 1/4"</p> <p>Dados 5mm, 5.5mm, 6mm, 7mm, 8mm, 9mm, 10mm, 11mm</p>	B-49373
<p>Puntas Forma C</p> <ul style="list-style-type: none"> ⊕ Pz0, Pz1, Pz2 (x2), Pz3 ⊕ PH0, PH1, PH2 (x2), PH3 ⊕ T10, T15, T20, T25, T30 ● SL0.5x3 SL0.5x4 SL0.6x5 SL1x6 (x2) 	

Juego de accesorios

Empaque con 100 piezas

NUEVO



Contenido	No. Parte
<p>Puntas 25mm</p> <ul style="list-style-type: none"> ⊕ T10, T15, T20 (x2), T25 (x2), T30, T40 ● SL4 (x2) SL5 (x2) SL5.5 (x2) SL6.5(x2) ⊕ Pz0 (x2), Pz1(x2), Pz2 (x3), Pz3 (x3) ⊕ PH0 (x2), PH1(x2), PH2 (x3), PH3 (x3) <p>Puntas 50mm</p> <ul style="list-style-type: none"> ⊕ PH1, PH2, PH3 ⊕ Pz1, Pz2, Pz3 ⊕ T20, T25, T30, T40 ● SL5.5, SL6.5 <p>Brocas para metal: 1.5mm, 2mm, 2.5mm, 3mm, 3.2mm, 3.5mm, 4mm, 4.5mm, 5mm, 5.5mm, 6mm, 6.5mm, 7mm, 8mm</p> <p>Brocas para hormigón: 3mm, 4mm, 5mm, 6mm, 8mm, 10mm</p> <p>Brocas para madera: 3mm, 4mm, 5mm, 6mm, 7mm, 8mm, 10mm</p> <p>Brocas tipo manita para madera: 16mm, 20mm, 25mm</p> <p>Avellanador / Guía magnética</p> <p>Medidor de diámetro / Medidor de profundidad</p> <p>Llave allen</p> <p>Dados 6, 8, 10, 11, 12, 13</p>	D-47248

Juego de accesorios multipropósito Edición de aniversario

Empaque con 100 piezas



Contenido	No. Parte
<p>Puntas p/atornillar 25mm</p> <ul style="list-style-type: none"> ⊕ T10, T15 (x2), T20 (x2), T25 (x2), T27, T30 (x2), T40 ● SL0.5x4, SL0.6x4.5, SL1x5.5, SL1.2x6.5 ⊕ PH0, PH1, PH2 (x2), PH3 ○ H3, H4, H5, H6 ⊕ Pz0, Pz1, Pz2 (x2), Pz3 ST10, ST15, ST20, ST25, ST27, ST30, ST40 <p>Puntas p/atornillar 25mm Edición especial</p> <ul style="list-style-type: none"> ⊕ PH0 (x2), PH1 (x2), PH2 (x3), PH3(x3) ⊕ Pz0 (x2), Pz1(x2), Pz2 (x3), Pz3 (x3) ⊕ T10, T15, T20, T25, T30, T40 ● SL0.8x4, SL1.0x5.5, SL1x6.0, SL1.2x6.5 ○ H3, H4, H5, H6 <p>Brocas HSS 1/8", 9/64", 5/32", 3/16", 1/4"</p> <p>Brocas para Madera 1/8", 3/16", 1/4", 5/16", 3/8"</p> <p>Brocas de manita 3/8", 1/2", 5/8"</p> <p>Adaptador 1/4" zanco Hex.</p> <p>Adaptador magnético 1/4" zanco Hex.</p> <p>Puntas p/atornillar caja flip: PZ2(x5), PH2(x5)</p> <p>Dados magnéticos 1/4" zanco Hex.: 1/4", 5/16", 3/8", 7/16", 1/2"</p>	B-45375

Juego de accesorios Makpac 116 pzs.

Empaque con 116 piezas

Contenido	No. Parte
<p>Juego de puntas c/ brocas para herramienta HSS-G</p> <p>Brocas HSS-G p/metal 1.5, 2, 2.5, 3, 3.2, 3.5, 4, 4.5, 5, 6mm</p> <p>Dados p/tornillos de cabezal hexagonal 4mm, 5mm, 6mm, 8mm, 10mm</p> <p>Puntas p/atornillador 25mm:</p> <ul style="list-style-type: none"> ⊖ T10, T15 (x2), T20 (x2), T25 (x2), T30 (x2), T40 ⊕ PH1 (x2), PH2 (x2), PH3 ○ HS, H2.5, H3, H4, H5(x2), H6 (x2) ⊕ Pz1 (x2), Pz2 (x2), Pz3 <p>S0 64.5 S0 85.5 S12 6.5 (x2)</p>	B-49884
<p>Juego de brocas c/18 pzs con estuche</p> <p>Brocas HSS-G p/metal fresadas 1/8", 5/32", 3/16", 1/4", 5/16", 3/8"</p> <p>Brocas p/madera 1/8", 5/32", 3/16", 1/4", 5/16", 3/8"</p> <p>Brocas p/concreto (industriales) HMCT 1/8", 5/32", 3/16", 1/4", 5/16", 3/8"</p> <p>Dados p/tornillos de cabezal hexagonal 5mm, 6mm, 7mm, 8mm, 9mm, 10mm, 11mm</p> <p>Adaptador p/puntas tipo broquero</p> <p>Atornillador tipo matraca</p> <p>Atornillador manual tipo matraca</p> <p>Puntas p/atornillador 25mm:</p> <ul style="list-style-type: none"> ⊕ PH1 (x2), PH2 (x2), PH3(x2) ⊕ Pz1 (x2), Pz2 (x2), Pz3(x2) ⊖ T10(x2), T15 (x2), T20 (x2), T25 (x2), T30 (x2), T40 ○ H2, H2.5, H3, H4(x2), H5(x2), H6 (x2) S0 6x4.5 (x2) S0 8x5.5 (x2) S1 2 x6.5 (x2) 	



Estuche de plástico para discos de diamante

Ideal para guardar y transportar discos

Puede guardar discos de 4" (8pzs) a 5" (2pzs)



Cuenta con un compartimento para anillos

Tamaño	Piezas empaque	No. Parte
150x145x130mm	1pz	D-63862

Flexómetros

Para usuarios de bricolaje, talleres de reparaciones, decoradores de interiores, etc



Contenido	Medida	Empaque piezas	No. Parte
NUEVO Flexometro	2 metros	1	E-10590
Flexometro	3 metros	1	D-64989

Estuche de plástico en forma de batería LXT

Para guardar accesorios



NUEVO

Ideal para guardar y transportar accesorios pequeños

Contenido	Tamaño (mm)	Empaque piezas	No. Parte
Estuche de plástico		1	B-69917

Estuche de plástico

Para guardar accesorios



Ideal para guardar y transportar accesorios pequeños

Contenido	Tamaño (mm)	Empaque piezas	No. Parte
Estuche de plástico	Mediano (150x102x44)	1	B-62072

Cutter con 7 navajas de repuesto

Para usuarios de bricolaje, talleres de reparaciones, decoradores de interiores, etc



*Nuevo color Azul

Fácil cambio de navaja (8 navajas en total)



Extraiga la navaja usada, deslice la palanca hacia abajo



Se cargará automáticamente una nueva navaja, facilitando el cambio a los usuarios.



Al retirar la navaja superior se carga automáticamente la siguiente navaja



Contenido	Color	Piezas empaque	No. Parte
Cutter con 7 navajas de repuesto	Gris	1pz	D-58861
Cutter con 7 navajas de repuesto	Azul	1pz	D-65713 NUEVO
Cuchillas de repuesto para cutter		10pzs	D-74734 NUEVO

40v Li-ion max



BATERÍAS

LÁMPARAS Y CARGADORES

DML810

LÁMPARA DE TRABAJO

HASTA
3 HORAS

DE OPERACIÓN CONTINUA

Con 2 baterías LXT® Litio-Ion de 18V 5.0 Ah en modo alto.

Función de advertencia de capacidad de batería

notifica automáticamente sobre la reducción en la capacidad de la batería con la disminución de la iluminación .

Switch

-Interruptor de brillo de 3 etapas
-Encendido / apagado
Interruptor de encendido
-Conmutador de área de iluminación ajustable.

HASTA
18 HORAS

DE OPERACIÓN CONTINUA

Con 2 baterías LXT® Litio-Ion de 18V 5.0 Ah en el ajuste bajo.

Luces Led

Iluminan eficazmente el área de trabajo sin el alto calor de halógenos y luces incandescentes.

Alimentado por DC (Corriente directa)

Utiliza 2 baterías LXT® Litio-Ion de 18V pero opera utilizando 1 batería a la vez; puede utilizar la segunda batería en caso de ser necesario.



Cable de alimentación de AC (Corriente alterna)

Desmontable, puede almacenarse de forma compacta en la parte posterior del cuerpo de la luz cuando no está en uso.



Conexión multiple

Se pueden conectar hasta 8 unidades en serie.



Asa de transporte



Mangos ergonómicos
Para fácil transportación y manejo.

Cuenta con reflejantes para ayudar a ubicarlo en la oscuridad.

IPX54

Resistencia certificada al polvo y salpicaduras agua (solo con alimentación de DC)



Diseño auto estabilizante
recuperará el equilibrio incluso en condiciones extremas de movimiento.

3 MODOS DE OPERACIÓN



180° izquierdo

360°

180° derecho

LXT

AJUSTABLE AL ÁREA DE OPERACIÓN

LÁMPARA DE TRABAJO

DML810

Tiempo de Ejecución:	18 hrs.
Iluminancia:	a 1 m de la fuente de luz
(Alta/medio/Baja) :	:500 / 300 / 150 lx
	a 3 m de la fuente de luz: 70 / 40 / 20 lx
	a 5 m de la fuente de luz: 25 / 15 / 7 lx
Flujo luminoso	Alta 5,500 / Medio 3,000 / Baja 1,500
Dimensiones (L x W x H)	420x420x787mm (161/2 x 16- 1/2 x31")
Peso neto	13.9-15.3 kg (30.6-33.7 lbs)

El modelo DML810 Z no incluye cargador ni batería

LÍNEA XGT 40Vmax

XGT es un nuevo sistema con su línea propia de herramientas, baterías y cargadores, con una combinación de diseño innovador en el motor de sus herramientas y un mayor rendimiento de las baterías, proporcionando una solución completa para altas demandas de usuarios industriales.

Sistema de suministro de energía y sistema de carga óptimo

La gama de herramientas y baterías XGT viene con un programa incorporado que proporciona comunicación digital entre la batería y la herramienta y viceversa, ingeniería que trabaja en conjunto para un óptimo desempeño.

BATERÍAS 40Vmax

Construcción resistente

- Alta durabilidad.
- Diseño con especificaciones especiales para batería 40Vmax.
- Resistente a las caídas.
- Comunicación digital entre batería y herramienta.

Luz LED con 4 indicadores de carga

Gran visibilidad en lugares con mucha luz

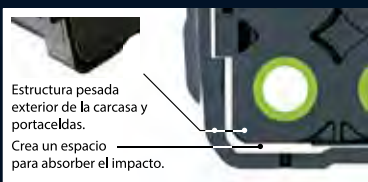
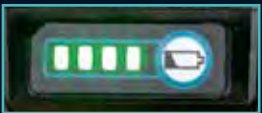

Estructura de absorción de choque

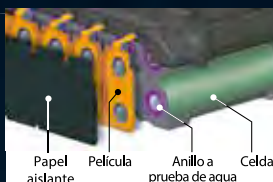

Estructura impermeable de triple capa

Previene la falla de las celdas debido al agua y polvo.



Muro de protección

Estructura de prevención de corto circuito

Muro de protección entre las terminales, protege contra polvo y gotas de agua.



Riel de la batería

Rieles de alta rigidez

Deslizamiento duradero en el riel de la batería, sujetándola con firmeza a la herramienta.

Herramienta ◀▶ Batería ◀▶ Cargador Comunicación Digital



Sistema óptimo de carga.

Sistema de mantenimiento automático con dos ventiladores que proporcionan un mejor sistema de carga óptimo.

Sistema óptimo de carga



Carga rápida

Es necesario enfriar la batería antes de empezar a cargarla cuando la temperatura de la batería es alta después de usarla.

El ventilador incorporado hace circular el aire a través de la batería antes de comenzar a cargar y durante el proceso de carga para enfriar rápidamente la batería y acelerar el tiempo de carga.

Sistema óptimo de carga

Enfriamiento por aire balanceado



Carga rápida



Método de carga general

Disipación de calor normal



más tiempo de espera para cargar



Protección de la batería Resistencia extrema



La batería cuenta con una tecnología que permite la comunicación entre la batería y la herramienta, monitoreando las condiciones e intercambiando datos en tiempo real para protegerla contra sobrecarga, sobredescarga y sobrecalentamiento, esto permite alargar la vida útil de la batería.

Carga en cualquier momento

Sin efecto de memoria
No requiere descarga



Absorbe el impacto

Carcasa de la batería de alta resistencia



Largo almacenamiento

Baja autodescarga



El cargador rápido Makita se comunica con el chip incorporado de la batería durante todo el proceso de carga para optimizar la vida útil de la batería controlando activamente la corriente, el voltaje y la temperatura.



Sistema óptimo de carga

Método de carga general

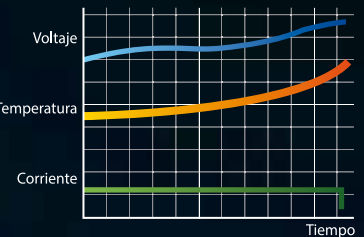
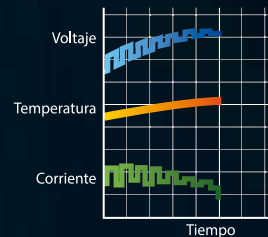









Conexión estable

Las terminales multi-contacto incrementan la conexión segura, además de soportar la vibración, asegurando una distribución de la corriente estable para la herramienta.



Baterías y cargadores

○ Tiempo de carga Li-ion 40V // 80Vmax XGT

 40V // 80Vmax Lithium-ion		 DC40RA rápido	 DC40RB Multicargador de 2 puertos	 DC40RC
8.0 Ah	 BL4080F	76 min.	76 min.	170 min.
5.0 Ah	 BL4050F	50 min.	50 min.	85 min.
4.0 Ah	 BL4040	45 min.	45 min.	67 min.
2.5 Ah	 BL4025	28 min.	28 min.	38 min.
2.0 Ah	 BL4020	22 min.	22 min.	30 min.



Adaptador ADP10



No. parte 191C09-2



El adaptador permite cargar baterías de 18V Li-ion

Adaptador para USB//ADP001G

Proporciona una salida de 4.2Ah para cargar celulares inteligentes, tablets, etc.



○ Tiempo de carga Li-ion 18V / 14.4V









Adaptador para USB//ADP05

2 salidas de puerto USB con tapa. Proporciona una salida de 4.2Ah para cargar celulares inteligentes, tablets, etc.





Clip para cinturón

		18V Lithium-ion	14.4V Lithium-ion			DC18RC rápido	Carga de 1 a 4 baterías al mismo tiempo	DC18SD	DC40RA Cargador rápido de 40V
6.0 Ah	 BL1860B	 BL1460B Automotriz		55 min.	1 ó 2 baterías 130 min.	55 min.	3 ó 4 baterías 260 min.	130 min.	40 min. BL1860B
5.0 Ah	 BL1850B			45 min.	110 min.	45 min.	220 min.	110 min.	35 min. BL1850B
4.0 Ah	 BL1840B			36 min.	90 min.	36 min.	180 min.	90 min.	29 min. BL1840B
3.0 Ah	 BL1830B	 BL1430B Automotriz		22 min.	60 min.	22 min.	120 min.	60 min.	22 min. BL1830B
1.5 Ah	 BL1815N	 BL1415NA Automotriz		15 min.	30 min.	15 min.	60 min.	30 min.	15 min. BL1815N

○ Baterías y cargadores Li-ion 18V / 12V / 7.2V

18V Lithium-ion	 BL1815G	70 min.	 BL1820G	90 min.	 DC18WA	12V Lithium-ion	 BL1014	50 min.	 (630663-4)	7.2V Lithium-ion	 BL0715	50 min.	 (630663-4)
1.5Ah	BL1815G		BL1820G			1.3Ah	BL1014		(630663-4)	1.3Ah	BL0715		(630663-4)

○ Tiempo de carga CXT 12Vmax

12V Lithium-ion		DC10SB	DC18RE Cargador Dual LXT y CXT	DC10WD
4.0 Ah	 BL1041B	60 min.		130 min.
2.0 Ah	 BL1021B	30 min.		70 min.
1.5 Ah	 BL1016	22 min.		50 min.

CXT

Entrada para baterías 18V **LXT**











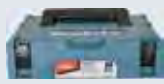









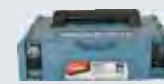

Entrada para baterías 12V **CXT**

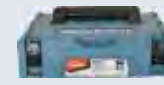

Cargador dual para baterías LXT y CXT

Apto para cargar baterías de 18V y 12V de cualquier amperaje

○ Kits de baterías y cargadores

40V Lithium-ion XGT	Kit de estuche Makpac con baterías de 8.0Ah y cargador (191Y94-7)	 +  + 	8.0Ah	40V Lithium-ion XGT	Kit de batería de 4.0Ah y cargador (191J61-2)	 + 	4.0Ah
40V Lithium-ion XGT	Kit de estuche Makpac con baterías de 5.0Ah y cargador (191U43-0)	 +  + 	5.0Ah	18V Lithium-ion LXT	Kit de estuche con baterías de 6.0Ah y cargador (198087-5)	 +  + ESTUCHE	6.0Ah
40V Lithium-ion XGT	Kit de estuche Makpac con baterías de 4.0Ah y cargador (191U29-4)	 +  + 	4.0Ah	18V Lithium-ion LXT	Kit de estuche con baterías de 6.0Ah y cargador (198113-0)	 +  + ESTUCHE	6.0Ah
40V Lithium-ion XGT	Kit de estuche Makpac con baterías de 4.0Ah y cargador (191J93-9)	 +  + 	4.0Ah	18V Lithium-ion LXT	Kit de batería de 5.0Ah y cargador (191L70-3)	 + 	5.0Ah
40V Lithium-ion XGT	Kit de estuche Makpac con baterías de 2.5Ah y cargador (191J77-7)	 +  + 	2.5Ah	18V Lithium-ion LXT	Kit de batería de 3.0Ah y cargador (191M70-9)	 + 	3.0Ah
40V Lithium-ion XGT	Kit de estuche Makpac con baterías de 2.0Ah y cargador (191V16-9)	 +  + 	2.0Ah	18V Lithium-ion LXT	Kit de batería de 3.0Ah y cargador (199992-9)	 + 	3.0Ah

Checkador de baterías

No. Parte 194919-4

Indispensable para revisar la vida útil de las baterías. Funciona con baterías Ni-Cd, Ni-Mg y Li-ion hasta 24V



Descripción	Empaque pieza	No. Parte
Incluye: checkador de baterías, adaptador para cargas de refresco, adaptador para baterías Ni-cd, software de instalación, cables de conexión a puerto p/ PC, maletín. Funciona con cargador DC24SA, no incluido.	1	194919-4

Adaptadores

Descripción	Aplicación	Clave	Empaque Pieza	No. Parte
	Especial para modelos DFS, DSD, DTW, DTD, DSC	BAP18	1	191J40-0 NUEVO
	Baterías Makstar 24V.	BAP24	1	193689-2
	Baterías Li-Ion 36V.	BAP36N	1	A-51225
		ADP03	1	193681-8
	Checkador de baterías		Juego 2 Piezas	194088-1
	Para baterías de 12V, 14.4V, 18V Voltaje de salida: 5V	18V LXT	1	ADP05
		12V max CXT	1	ADP06
		CXT compacto	1	ADP08

Accesorios para herramientas inalámbricas

Usar en	Descripción	Empaque pieza	No. Parte
	SK312GD / SK209GD	1	TK0LM2000F NUEVO
	UH5570	1	158024-1
	BUB360	1	166095-4
	DTD153, DTD155, BDF441, DHP456, DHP483, DDF453, DTW1802, DTW251, DTW285	1	346449-3
	BL1430B, BL1440, BL1450, BL1460B, BL1830B, BL1840B, BL1850B	1	194649-7

Usar en	Descripción	Empaque pieza	No. Parte
	BTD146, BTD147, BDF458, BHP458	1	195798-3
	BTD133, BTD134, BTD135, BTD136, BTD145, BTD146, BTD147, BTP130, BTP140, BTS130, BTD130F, BDF440, BDF444, BDF445, BDF450, BDF454, BDF455, BHP440, BHP444, BHP450, BHP454, BHP455, BHP454A, BTD130F, BTW152	1	197043-2
		1	194731-2
	BJS130	1	281220-7
	BVR340 / BVR850	1	417383-5
	BFH040/F/090/120F	1	195231-5
	BTD120	1	417476-8
	6796FD, 6797FD, 6798FD, BFT120/F, BFT121F	1	417605-3
	6796FD, 6797FD, 6798FD, BFT120/F, BFT121F	1	417615-0
	6796FD, 6797FD, 6798FD, BFT120/F, BFT121F	1	417616-8
	BFL080F	1	418066-0
	Todos los atornilladores	1	421342-3
	BDA350	1	450688-0
	LXGC01Z	1	197195-9
	DCG180	1	196351-8
	DCG180	1	196352-6
	DFJ214	20 filtros y 2 marcos	198642-3 NUEVO
	DFJ214	20 filtros	198644-9 NUEVO



ACCESORIOS

LÁMPARAS

Prácticas lámparas para los sitios de trabajo con luz escasa

**Ninguna de las lámparas incluye cargador y baterías*

		Descripción	Dimensiones (LxAxA)	Peso Neto	Empaque Pieza	No. Parte
XGT		Luz de trabajo LED alimentada por batería Lítio-ion 40V 160 Lumens	232 x 88 x 92mm (9-1/8 x 3-1/2 x 3-5/8")	0.28 - 1.3 kg (0.62 - 2.9 lbs.)	1	ML001G
NUEVO						
XGT		Lámpara 40V 710 Lumens (con luz completa) 360 Lumens (con luz media)	376 x 86 x 137mm (14-3/4 x 3-3/8 x 5-3/8")	1.2 - 1.5 kg (2.6 - 3.3 lbs.)	1	ML002G
NUEVO						
XGT		Luz de trabajo inalámbrica 40V LXT Li-ion Cabezal de luz giratorio y plegable 500 Lumens	275 - 408 x 85 x 148mm (10-7/8 - 16 x 3-3/8 x 5-7/8")	1.1 - 1.7 kg (2.4 - 3.8 lbs.)	1	ML006GX
NUEVO						
XGT		Luz de trabajo inalámbrica de 40V LXT Li-ion 1,100 Lumens	249 x 298 x 280mm (9-3/4 x 11-3/4 x 11")	3.7 - 4.7 kg (8.2 - 10.4 lbs.)	1	ML003G
NUEVO						
LXT		Lámpara para iluminar áreas de trabajo 18V LXT Li-ion 5,500 Lumens	420 x 420 x 787mm (16-1/2 x 16-1/2 x 31")	13.9 - 15.3 kg (30.6 - 33.7 lbs.)	1	DML810
NUEVO						
LXT		Lámpara con base telescópica de hasta 2.2m 18V LXT Li-ion 3,000 Lumens	260 x 216 x 1,000mm (10-1/4 x 8-1/2 x 39-3/8")	7.4 - 8.1 kg (16.3 - 17.9 lbs.)	1	DML814
NUEVO						
LXT		Luz de trabajo inalámbrica 18V LXT Li-ion Cabezal de luz giratorio y plegable 240 Lumens	380 x 79 x 116mm (15 x 9-11/16 x 4-9/16")	0.61 - 0.98 kg (1.4 - 2.2 lbs.)	1	DML801
NUEVO						

El equipo estándar (accesorios), las especificaciones y las fotografías pueden variar. Los accesorios pueden no estar incluidos desde origen con las herramientas, aunque se indiquen en este catálogo.



Descripción	Empaque Pieza	No. Part	Descripción	Empaque Pieza	No. Parte
 Lámpara 36V Lithio recargable	1	STEXBML360	 Lámpara de mano cabeza móvil 4 posiciones 18V resistente a impactos de 1m	1	DML185
 Un solo LED de 1W para una iluminación brillante 18V, 14.4V	1	DML800	 Rádio para lugar de trabajo con triple LED de luz de destello 1.4W 18V, 14.4V	1	LXRM01
 Luz de trabajo LED alimentada por batería Litio-ion 18V	1	DML815	 Luz de trabajo inalámbrica de 96 LED LXT Li-ion	1	DML809
 Luz de trabajo LED alimentada por batería Litio-ion 18V	1	DML802	 Luz de trabajo inalámbrica 18V LXT Li-ion Cabezal de luz giratorio y plegable	1	DML816X
 Lámpara 18V Lithium Ion con clip para solapa o cinturón	1	BML803	 Adaptador imán	1	GM00001714
 Luz de trabajo LED alimentada por batería Litio-ion 18V, 14.4V y corriente alterna	1	DML805	 Lámpara LED, CXT 12V, Litio-ion	1	ML103
 Lámpara 18V, 14.4V Veinte LEDs blancos de 0.5W y un solo LED de 1W	1	DML806	 Lámpara LED, CXT 12V, Litio-ion Puerto USB	1	ML104
 Lámpara de mano de cabeza móvil inalámbrica 18V, 14.4V.	1	DML812	 Lámpara LED, CXT 12V, Litio-ion	1	ML105

Makita

No.B-57364
HW 165mmx20mm



HOJAS DE SIERRA



Diámetro interior



No. dientes



Ranura



Espesor



Rastrillo



Anillo



Corte al hilo



Corte transversal
ó a contra hilo



Punta incrustada



Silencioso



M-force



Corte rápido



Corte limpio



Corte extra limpio



Recubierto



Trabajo pesado



Larga vida



Punta PCD



Afilado

Hoja Sierra de Carburo

Forma del diente

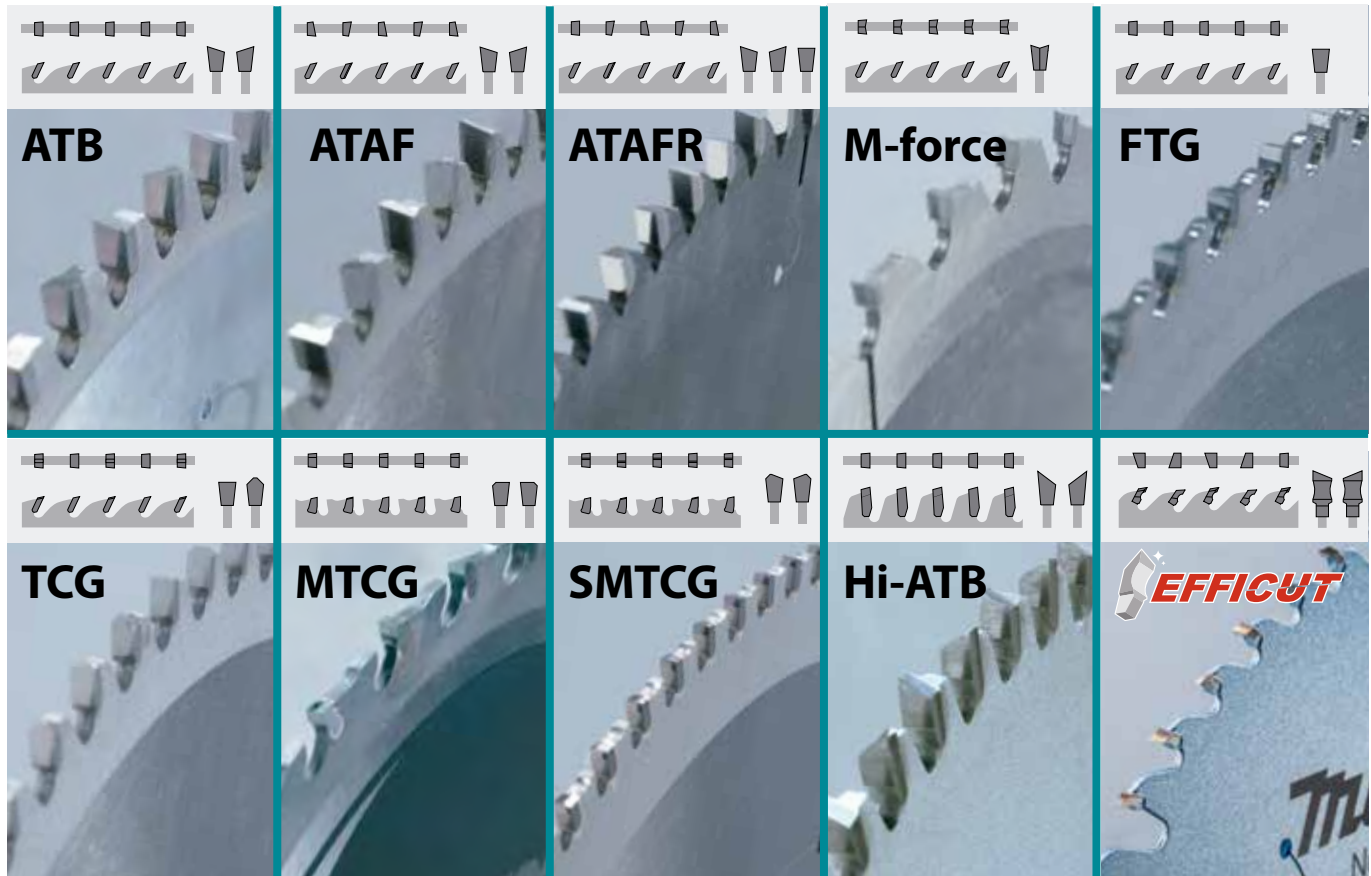

Término Técnico







<p>Hendidura láser</p>	<p>Cubierto</p>	<p>Punta Inclustada</p>	<p>Punta P.C.D.</p>
<p>Sistema de oscilación de amortiguación Resinbond, llenos de ranuras láser del cuerpo para cortes más suaves y estables.</p>	<p>PTFE (politetrafluoroetileno) Recubrimiento de politetrafluoroetileno para reducir el calor y que no reaccione con otras sustancias químicas.</p>	<p>El diseño del diente insertado incrementa en gran medida el área de la soldadura de cuerpo -a punta para un mayor apoyo y fuerza en punta.</p>	<p>PCD (Diamante Poli-Cristalizado) las pastillas son extremadamente fuertes con gran resistencia. Las pastillas PCD de los discos de corte son la mejor opción para un rendimiento de larga duración al cortar tableros de fibrocemento.</p>

EFFICUT



Recomendado para sierras circulares inalámbricas

Características

	<p>Eficiente ángulo superior agudo</p> 	<p>Permite realizar cortes finos con poco esfuerzo</p>
	<p>Eficiente cuerpo curvo</p> 	<p>Aumenta la eficiencia de liberación de desechos</p>
	<p>Eficiente fondo delgado</p> 	<p>Mejora el rendimiento de carga de la batería</p>

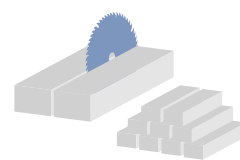

Más cortes por carga



Corte rápido



Duración de la batería más larga

Cantidad de corte por 1 carga

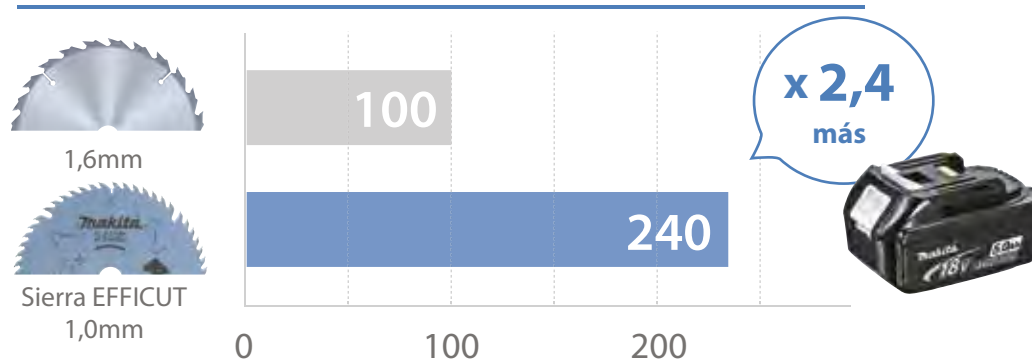

1. Los resultados de la prueba dependen de una buena medida de la dureza de los materiales de madera, etc.

2. Los gráficos de volumen de corte son valores relativos cuando la capacidad de la cuchilla actual (Espesor: 1,6mm) se indexa a 100.



Serie EFFICUT
IDEAL PARA HERRAMIENTAS INALÁMBRICAS

Para Madera



Eficiente ángulo superior agudo



Eficiente cuerpo curvo



Eficiente fondo delgado



Cantidad de cortes por carga

100

140%
Más

240

Para Metal

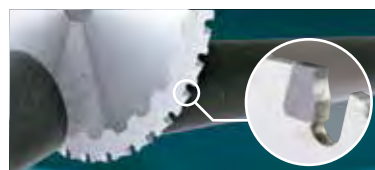

Fuerte y con menos astillas



Libera eficientemente las virutas



Superior en cortes rectos

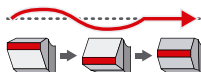

Cantidad de cortes por carga

100

60%
Más

160

Para Aluminio



Fuerte y con menos astillas



Reduce la resistencia al corte



Superior en cortes rectos

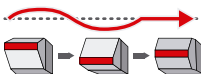

Suelta suavemente las virutas



Cantidad de cortes por carga

100

40%
Más

140

Recomendado para sierras circulares inalámbricas



Ideal para inalámbricos



Línea estándar Mod. SP6000 Carburo de tungsteno

Diámetro exterior (mm-In)	Perforación (mm-In)	Reductor (mm-In)	Grosor (mm)	Base (mm)	Dientes	Rastrillo	Forma del diente	Material	Nota	Piezas empaque	No. parte
165mm (6-1/2")	20mm	15.88(5/8")	1.45	1	56		ATAFR	Madera, MDF	Especial para SP6000	1	B-57370
165mm (6-1/2")	20mm	15.88(5/8")	1.4	1	25		ATAFR	Madera	Especial para SP6000	1	B-63002
185mm (7-1/4")	20mm	15.88(5/8")	1.45	1	24	12	ATAFR	Madera	Ideal para inalámbricos	1	B-62038
185mm (7-1/4")	20mm	-	1.45	1	45	23	Efficut	Madera	Ideal para inalámbricos	1	B-68600
260mm (10")	25.4mm	15.88(5/8")	2.15	1.65	45		ATAFR	Madera	Ideal para inalámbricos	1	B-64652
260mm (10")	30mm	15.88(5/8")			60		Efficut	Madera	Ideal para inalámbricos	1	B-67387
260mm (10")	30mm	15.88(5/8")			80		Efficut	Madera	Ideal para inalámbricos	1	B-67393
305mm (12")	30mm	15.88(5/8")			60		Efficut	Madera	Ideal para inalámbricos	1	B-67402
305mm (12")	30mm	15.88(5/8")			80		Efficut	Madera	Ideal para inalámbricos	1	B-67418
305mm (12")	30mm	15.88(5/8")			100		Efficut	Madera	Ideal para inalámbricos	1	B-67424

Recomendado para sierras circulares inalámbricas



Ideal para inalámbricos



Línea estándar Mod. DSS501 Carburo de tungsteno

Diámetro exterior (mm-In)	Perforación (mm-In)	Reductor (mm-In)	Grosor (mm)	Base (mm)	Dientes	Rastrillo	Forma del diente	Material	Nota	Piezas empaque	No. parte
136mm (5-3/8")	20mm	-	1.1	0.95	30	0	Efficut	Metal	Especial para DSS501	1	B-69381
136mm (5-3/8")	20mm	-	1.1	0.95	45	0	Efficut	Metal	Especial para DSS501	1	B-69397
150mm (6")	20mm	-	1.1	0.95	33	0	Efficut	Metal	Especial para DSS501	1	B-69406
150mm (6")	20mm	-	1.1	0.95	48	0	Efficut	Metal	Especial para DSS501	1	B-69412

Recomendado para sierras circulares inalámbricas



Ideal para inalámbricos



NUEVO

Diámetro exterior (mm-In)	Perforación (mm-In)	Reductor (mm-In)	Grosor (mm)	Base (mm)	Dientes	Rastrillo	Forma del diente	Material	Nota	Piezas empaque	No. parte
305mm (12")	-	-	-	-	81	-3°	Efficut	Aluminio	Para sierras de inglete	1	E-13275
305mm (12")	-	-	-	-	96	-3°	Efficut	Aluminio	Para sierras de inglete	1	E-13334

Ideal para corte silencioso y sierras circulares inalámbricas



Ideal para inalámbricos



Mod. DSP600 Carburo de tungsteno

	Diámetro exterior (mm)	Perforación (mm-In)	Reductor (mm-In)	Grosor (mm)	Base (mm)	Dientes	Rastrillo (grados)	Forma del diente	Material	Nota	Piezas empaque	No. parte
	165 (6-1/2")	20mm (3/4")	15.88(5/8")	1.45	1	44	23	TCG	Madera, MDF	Especial para DHS680RMJ	1	B-53235
	165 (6-1/2")	20mm (3/4")	15.88(5/8")	1.45	1	44	5	TCG	Madera	Especial para DHS680RMJ	1	B-53241
	165 (6-1/2")	20mm (3/4")	15.88(5/8")	1.6	1.1	55	23	ATAFR	Madera, MDF Laminado	Especial para DSP600/ DSP601	1	B-57087
	165 (6-1/2")	20mm (3/4")	15.88(5/8")	2	1.4	28	15	ATB	Madera	Ideal para DSP600/ DSP601	1	B-56867
	165 (6-1/2")	20mm (3/4")	15.88(5/8")	2	1.4	56	-3	TCG	Aluminio	Ideal para DSP600/ DSP601	1	B-56889
	165 (6-1/2")	20mm (3/4")	15.88(5/8")	2	1.4	60	5	Hi-ATB	MDF	Ideal para DSP600/ DSP601	1	B-56895
	165 (6-1/2")	20mm (3/4")	15.88(5/8")	2	1.4	60	5	TCG	MDF	Ideal para DSP600/ DSP601	1	B-56904
	165 (6-1/2")	20mm (3/4")	15.88(5/8")	2	1.4	48	5	ATB	Corian	Ideal para DSP600/ DSP601	1	B-56910
	165 (6-1/2")	20mm (3/4")	15.88(5/8")	2.2	1.6	42	5	Hi-ATB	MDF	Ideal para DSP600/ DSP601	1	B-56926
	165mm (6-1/2")	20mm	15.88(5/8")	1.85	1.25	48		ATB	Madera	Especial para SP6000	1	B-56873

El equipo estándar (accesorios), las especificaciones y las fotografías pueden variar. Los accesorios pueden no estar incluidos desde origen con las herramientas, aunque se indiquen en este catálogo.

Ideal para corte silencioso



Línea estándar Mod. SP6000 Carburo de tungsteno

	Diámetro exterior (mm)	Perforación (mm- In)	Reductor (mm- In)	Grosor (mm)	Base (mm)	Dientes	Rastrillo	Forma del diente	Material	Nota	Piezas empaque	No. parte
	165 (6-1/2")	20mm	15.88(5/8")	2.2	1.6	48	8	ATB	Madera	Especial para SP6000	1	B-07353
	165 (6-1/2")	20(3/4")	15.88(5/8")		1.2	24	12	ATB	Madera	Especial para SP6000		D-51306
	165 (6-1/2")	20(3/4")	15.88(5/8")			64		ATAF	Madera	Especial para SP6000	1	B-56524
	165 (6-1/2")	20(3/4")	15.88(5/8")			60		TCT	Aluminio	Especial para SP6000	1	B-56574
	165 (6-1/2")	20(3/4")	15.88(5/8")	2	1.2	24	12	ATB	Madera	Especial para SP6000	1	D-51312
	165 (6-1/2")	20(3/4")	15.88(5/8")	2	1.2	40	12	ATB	Madera	Especial para SP6000	1	D-51328
	165 (6-1/2")	20mm	15.88(5/8")	1.7		48		TCG	Corian	Especial para SP6000	1	B-10344
	165 (6-1/2")	20mm	-	2.4		56		TCG	Aluminio	Especial para SP6000	1	B-07440
	165 (6-1/2")	20mm	15.88(5/8")			52		TCG	MDF Melamina	Especial para SP6000	1	D-62474



Línea estándar Carburo de tungsteno

	Diámetro exterior (mm)	Perforación (mm- In)	Reductor (mm- In)	Grosor (mm)	Base (mm)	Dientes	Rastrillo	Forma del diente	Material	Nota	Piezas empaque	No. parte
	185 (7-1/4")	20(3/4")	15.88(5/8")	2.2	1.4	20	18	ATB	Madera		1	D-59106
	185 (7-1/4")	20(3/4")	15.88(5/8")	2.2	1.4	24	15	ATB	Madera		1	D-51340
	185 (7-1/4")	20(3/4")	15.88(5/8")	2.2	1.4	40	14	ATB	Madera		1	D-51356
	255 (10")	25.4mm	-	2.6	1.8	84		TCG	MDF		1	D-62452
	305 (12")	25.4mm	-			96		TCG	MDF		1	D-62468
	255 (10")	25.4mm	-	2.8	1.8	84		TCG	MDF		1	D-62480
	305 (12")	25.4mm	-			96		TCG	MDF		1	D-62496

Sierra circular Profesional

	Diámetro exterior (mm)	Perforación (mm- In)	Reductor (mm- In)	Grosor (mm)	Base (mm)	Dientes	Rastrillo	Forma del diente	Material	Nota	Piezas empaque	No. parte
	185 (7-1/4")	15.88/5/8"		2	1.3	24	18	ATB	Madera		1	D-03436
	185 (7-1/4")	15.88/5/8"		2	1.3	40	18	ATB	Madera		1	D-20688
	210 (8-1/4")	15.88/5/8"		2	1.3	24	20	ATB	Madera		1	D-21521
	210 (8-1/4")	15.88/5/8"		2	1.3	40	15	ATB	Madera		1	D-31728
	210 (8-1/4")	15.88/5/8"		2.4	1.6	48	20	ATB	Madera		1	A-95934
	235 (9-1/4")	25.4(1")	25/15.88mm	2.5	1.6	40	12	ATB	Madera		1	D-51378
	235 (9-1/4")	25.4(1")	25/15.88mm	2.5	1.6	60	12	ATB	Madera		1	D-51384



Línea estándar "Sierras manuales"

Empaque de 2 Y 3 Pzs.



	Diámetro exterior (mm)	Perforación (mm- In)	Reductor (mm- In)	Grosor (mm)	Base (mm)	Dientes	Rastrillo	Forma del diente	Material	Nota	Piezas empaque	No. parte
	185 (7-1/4")	1-3/16"	15.88mm-5/8"	2	1	16-20-40		ATB	Madera		1c/u 3Pzs	D-44769
	235(9-1/4")	1-3/16"	15.88mm-5/8"	2.4	1.4	20-48-60		ATB	Madera		1c/u 3Pzs	D-44775
	185 (7-1/4")	1-3/16"	15.88mm-5/8"	2.2	1.6	24	25	ATB	Madera		1	D-59097
	235 (9-1/4")	25.4 /1"	25mm-5/8"	2.4	1.6	24	25	ATB	Madera		1	B-19146
	235 (9-1/4")	25.4 /1"	25mm-5/8"	2.4	1.6	40	25	ATB	Madera		1	B-19152
	235 (9-1/4")	25.4 /1"	25mm-5/8"	2.4	1.6	60	20	ATAF	Madera		1	B-19168
	235 (9-1/4")	25.4 /1"	25mm-5/8"	2.4	1.6	80	15	ATAF	Madera		1	B-19174
	235 (9-1/4")	25.4 /1"	25mm-5/8"	2.4	1.6	40	18	ATB	Madera		1	D-03377
	235 (9-1/4")	30/1-3/16"	25.4mm 25mm-1"	2	1.6	20	20	ATB	Madera		1	D-03925

Sierra circular / Sierra de inglete / sierra de inglete compuesto

NUEVO

	Diámetro exterior (mm)	Diámetro interior (mm- In)	Anillo	Dientes	Rastrillo	Forma del diente	Material	Nota	Piezas empaque	No. parte
	210 mm	25.4 mm (1")	15.88mm	24	15°	ATB	Madera	Sierra Circular	1	D-72394
	210 mm	25.4 mm (1")	15.88mm	40	15°	ATB	Madera	Sierra Circular	1	D-72403
	305 mm (12")	25.4 mm (1")		60	15°	ATB	Madera	Sierra de Inglete	1	D-72419
	305 mm (12")	25.4 mm (1")		80	15°	ATB	Madera	Sierra de Inglete	1	D-72425
	305 mm (12")	25.4 mm (1")		100	15°	ATB	Madera	Sierra de Inglete	1	D-72431

Sierra de inglete compuesto/Sierra de inglete



Diámetro exterior (mm)	Diámetro interior (mm)	Perforación (mm- In)	Anillo (mm)	Grosor (mm)	Base (mm)	Dientes	Rastrillo	Forma del diente	Material	Nota	Piezas empaque	No. parte
255(10")	25.4	30/1-3/16"	15.88	2.3	1.8	40	5	ATB	Madera		1	B-19233
255(10")	25.4	30/1-3/16"	15.88	2.3	1.8	60	5	ATB	Madera		1	B-19249
255(10")	25.4	30/1-3/16"	15.88	2.3	1.8	80	5	ATB	Madera		1	B-19255
255(10")	25.4	30/1-3/16"	15.88	2.3	1.8	100	5	ATB	Madera		1	B-19261
305(12")	25.4	30/1-3/16"	-	2.3	1.8	60	5	ATB	Madera		1	B-19364
216mm (8-1/2")	25.4	-	-	1.5	2	60	10	Efficut	Madera	Ideal para inalámbricos	1	E-08947 NUEVO
216mm (8-1/2")	25.4	-	-	1.5	2	80	10	Efficut	Madera	Ideal para inalámbricos	1	E-08953 NUEVO

Sierra de inglete compuesto/Sierra de inglete

Línea Estándar.



	Diámetro exterior (mm)	Perforación (mm- In)	Anillo (mm)	Grosor (mm)	Base (mm)	Dientes	Rastrillo	Forma del diente	Material	Nota	Piezas empaque	No. parte
	260(10")	25.4mm	-	2.6	1.8	40	15	ATB	Madera		1	D-65414
	260(10")	25.4mm	-	2.6	1.8	60	15	ATB	Madera		1	D-65420
	260(10")	25.4mm	-	2.6	1.8	80	12	ATB	Madera		1	D-65436
	260(10")	25.4mm	-	2.6	1.8	100	12	ATB	Madera		1	D-65442

El equipo estándar (accesorios), las especificaciones y las fotografías pueden variar. Los accesorios pueden no estar incluidos desde origen con las herramientas, aunque se indiquen en este catálogo.

Sierras de banco línea industrial

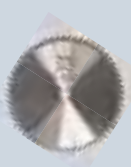

	Diámetro exterior (mm)	Perforación (mm- In)	Anillo (mm)	Grosor (mm)	Base (mm)	Dientes	Rastrillo	Forma del diente	Material	Nota	Piezas empaque	No. parte
	255(10")	30/1-3/16"	25.4/15.88	2.8	2	24	25	ATB	Madera		1	B-19392
	255(10")	30/1-3/16"	25.4/15.88	2.8	2	30	25	ATB	Madera		1	B-19401
	255(10")	30/1-3/16"	25.4/15.88	2.8	2	36	25	ATB	Madera		1	B-19417
	255(10")	30/1-3/16"	25.4/15.88	2.8	2	40	25	ATB	Madera		1	B-19423
	255(10")	30/1-3/16"	25.4/15.88	2.8	2	48	20	ATAF	Madera		1	B-19439
	255(10")	30/1-3/16"	25.4/15.88	2.4	1.8	60	20	ATAF	Madera		1	B-19445
	255(10")	30/1-3/16"	25.4/15.88	2.4	1.8	80	15	ATAF	Madera		1	B-19451
	255(10")		1-3/16"	2.3	2	80		ATB	Madera		1	B-03551
	305(12")		25.4 /1"	2.3	1.8	60		ATB	Madera		1	B-03676
	305(12")	30/1-3/16"	25.4 /1"	3	2.2	30	25	ATB	Madera		1	B-19489
	305(12")	30/1-3/16"	25.4 /1"	3	2.2	36	25	ATB	Madera		1	B-19495
	305(12")	30/1-3/16"	25.4 /1"	3	2.2	40	25	ATB	Madera		1	B-19504
	305(12")	30 1-3/16"	25.4 /1"	3	2.2	48	20	ATAF	Madera		1	B-19510
	305(12")	30/1-3/16"	25.4 /1"	2.8	2	60	20	ATAF	Madera		1	B-19526
	305(12")	30/1-3/16"	25.4 /1"	2.8	2	80	15	ATAF	Madera		1	B-19532

Sierras de banco





	Diámetro exterior (mm)	Perforación (mm- In)	Anillo (mm)	Grosor (mm)	Base (mm)	Dientes	Rastrillo	Forma del diente	Material	Nota	Piezas empaque	No. parte
	255(10")	30/1-3/16"	25.4/1" 15.88/5/8"	2.8	1.8	40	20	ATB	Madera	Hendidura láser	1	B-19467
	305(12")	30/1-3/16"	25.4 /1"	2.8	1.8	48	20	ATB	Madera	Hendidura láser	1	B-19548
	305(12")	30/1-3/16"	25.4/1"	2.8	1.8	100	15	ATAFR	Madera	Hendidura láser	1	B-19554

*Punta especializada para corte de clavos

Sierra circular Uso industrial



	Diámetro exterior (mm)	Perforación (mm- In)	Anillo (mm)	Grosor (mm)	Base (mm)	Dientes	Rastrillo	Forma del diente	Material	Nota	Piezas empaque	No. parte
	185(7-1/4")	20	15.88/5/8"	1.85	1.25	16	25	ATB	Madera	Punta incrustada	1	B-19118
	185(7-1/4")	20	15.88/5/8"	1.85	1.25	20	25	ATB	Madera	Punta incrustada	1	B-19124
	185(7-1/4")	20	15.88/5/8"	1.85	1.25	40	25	ATB	Madera	Punta incrustada	1	B-19130
	185(7-1/4")	5/8"	15.88/5/8"	1.2	1	24		ATB	Madera		1	A-94530*
	185(7-1/4")	5/8"	15.88/5/8"	1.8	1.2	36		TCG	Madera		1	A-98778*

Especializado para corte silencioso

A batería



	Diámetro exterior (mm)	Perforación (mm- In)	Anillo (mm)	Grosor (mm)	Base (mm)	Dientes	Rastrillo	Forma del diente	Material	Nota	Piezas empaque	No. parte
	3-3/8"	15mm	n/a	1.1	1	50		ATB	Plástico		1	792299-8
	4"	7/8"	n/a	1.2	1	6		ATB	Madera		1	A-95118
	4-3/8"	20mm	n/a	1.8	1.2	24		ATB	Madera		1	A-81359
	4-3/8"	20mm	n/a	1	0.9	20	18	ATB	Madera		1	792010-8
	4-3/8"	20mm	n/a	1.8	1.2	12	20	ATB	Madera		1	A-90093

Especializado para corte de melamina

Sierra circular

Sierras de banco (*Delgados)



Diámetro exterior (mm)	Perforación (mm- In)	Anillo (mm)	Grosor (mm)	Base (mm)	Dientes	Rastrillo	Forma del diente	Material	Nota	Piezas empaque	No. parte
250(10")	30 1-3/16"	25.4/15.88	3.2	2.2	80	5	TCG	Madera/MDF	Para sierra circular Con cubierta Hendidura láser	1	B-39263
300(12")	30 1-3/16"	25.4/1"	3.2	2.2	96	5	TCG	Madera/MDF	Para sierra circular Con cubierta Hendidura láser	1	B-39279
250(10")	30 1-3/16"	25.4/15.88	3.2	2.2	80	-5	Hi-ATB	Madera/MDF	Para sierra circular Con cubierta Hendidura láser	1	B-39285
300(12")	30 1-3/16"	25.4/1"	3.2	2.2	96	-5	Hi-ATB	Madera/MDF	Para sierra circular Con cubierta Hendidura láser	1	B-39291
185 (7 1-4")	20mm							Madera/MDF	Para sierra circular Con cubierta Hendidura láser	1	D-61466
255mm	25.4/1"	15.88mm			100	10°		Melamina	Para sierra de inglete y sierra de inglete compuesto	1	D-72279 NUEVO
260mm	25.4/1"	15.88mm			84	10°		Melamina	Para sierra de inglete y sierra de inglete compuesto	1	D-72285 NUEVO
250(10")	30 1-3/16"	25.4/15.88	2.6	1.8	80	-5	Hi-ATB	Madera/MDF	Para sierra de banco Con cubierta Hendidura láser	1	B-42628*
300(12")	30 1-3/16"	25.4/1"	2.6	1.8	96	-5	Hi-ATB	Madera/MDF	Para sierra de banco Con cubierta Hendidura láser	1	B-42634*

Especializado para corte de aluminio estándar

Sierra circular Mod. CA5000



Diámetro exterior (mm)	Perforación (mm- In)	Anillo (mm)	Grosor (mm)	Base (mm)	Dientes	Rastrillo	Forma del diente	Material	Nota	Piezas empaque	No. parte
118(4-1/2")	20	15.88 /5/8"			6		TCG	Aluminio	90°	1	B-48832
118(4-1/2")	20	15.88 /5/8"			6		TCG	Aluminio	135°	1	B-48860

Especializado para corte de aluminio estándar

Sierra circular



Diámetro exterior (mm)	Perforación (mm- In)	Anillo (mm)	Grosor (mm)	Base (mm)	Dientes	Rastrillo	Forma del diente	Material	Nota	Piezas empaque	No. parte
185(7-1/4")	15.88(5/8")		2.2	1.5	40	5	FTG	Aluminio		1	D-03464
185(7-1/4")	15.88 /5/8"		2.2	1.3	40	5	TCG	Aluminio		1	D-62125

Especializado para corte de aluminio estándar

Sierra de inglete compuesto /sierra de inglete



Diámetro exterior (mm)	Perforación (mm- In)	Anillo (mm)	Grosor (mm)	Base (mm)	Dientes	Rastrillo	Forma del diente	Material	Nota	Piezas empaque	No. parte
255(10")	15.88(5/8")		2.3	1.8	80	-5	TCG	Aluminio		1	A-93887
255(10")	15.88(5/8")		2.3	1.8	100	-5	TCG	Aluminio		1	A-93893
255(10")	1-3/16"		2.4	1.8	100		TCG	Aluminio		1	B-19788
255(10")	15.88(5/8")		2.8	2	70	0	TCG	Aluminio		1	D-19059
255(10")	15.88(5/8")		2.8	2	100	-3	TCG	Aluminio		1	D-19065
255(10")	15.88 (5/8")		2.8	2	70	-3	TCG	Aluminio		1	D-19065-1
255(10")	15.88 (5/8")		2.4	1.8	100		TCT	Aluminio		1	D-61896
255(10")	15.88 (5/8")		2.4	1.8	100		TCT	Aluminio		1	D-61905

Sierra de inglete compuesto/sierra de inglete



Diámetro exterior (mm)	Perforación (mm- In)	Anillo (mm)	Grosor (mm)	Base (mm)	Dientes	Rastrillo	Forma del diente	Material	Nota	Piezas empaque	No. parte
305(12")	25.4(1")		2.3	1.8	80	-5	TCG	Aluminio		1	A-93902
305(12")	25.4(1")		2.3	1.8	100	-5	TCG	Aluminio		1	A-93918
305(12")	30 1-3/16"	25.4 /1"	2.3	1.8	80	-5	TCG	Aluminio		1	B-19766
305(12")	30 1-3/16"	25.4 /1"	2.3	1.8	100	-5	TCG	Aluminio		1	B-19772
305(12")	25.4(1")		3	2.2	80	5	TCG	Aluminio		1	D-03486

El equipo estándar (accesorios), las especificaciones y las fotografías pueden variar. Los accesorios pueden no estar incluidos desde origen con las herramientas, aunque se indiquen en este catálogo.

Especializado para corte de aluminio estándar

Sierra de banco



Diámetro exterior (mm)	Perforación (mm- In)	Anillo (mm)	Grosor (mm)	Base (mm)	Dientes	Rastrillo	Forma del diente	Material	Nota	Piezas empaque	No. parte
305(12")	30/ 1-3/16"	25.4/ 1"	2.6	2	100	0	ATB	Aluminio		1	B-19794
305(12")	30/ 1-3/16"	25.4/ 1"	2.6	2	120	0	ATB	Aluminio		1	B-19803

Especializado para corte de metal

Sierra circular de metal



Diámetro exterior (mm)	Perforación (mm- In)	Anillo (mm)	Grosor (mm)	Base (mm)	Dientes	Rastrillo	Forma del diente	Material	Nota	Piezas empaque	No. parte
150(5-7/8")	20	15.88(5/8")	1.8	1.5	32	0	MTCG	Metal		1	B-47195
150(5-7/8")	20	15.88(5/8")	1.8	1.5	52	0	ATB	Lámina de metal		1	B-47204
150(6")	20	15.88(5/8")	1.8	1.5	60	0	SMTCCG	Inox		1	B-47210
150(6")	20	15.88(5/8")	1.8	1.5	52	0	CTG	Aluminio		1	B-47226
185(7-1/4")	20	15.88(5/8")	1.9	1.5	36	0	ATB	Acero dulce		1	B-33912
185(7-1/4")	20	15.88(5/8")	2	1.6	38	0	MTCG	Acero dulce		1	B-33928
185(7-1/4")	20	15.88(5/8")	2	1.6	48	0	MTCG	Acero dulce delgado		1	B-33934
185(7-1/4")	20	15.88(5/8")	1.7	1.3	70	-10	FTG	Base de acero corrugado		1	B-33940
185(7-1/4")	20	15.88(5/8")	1.85	1.5	48	0	SMTCCG	Acero dulce	Larga vida	1	B-23341
185(7-1/4")	20	15.88(5/8")	1.8	1.5	56	0	SMTCCG	Acero dulce delgado	Larga vida	1	B-23385
185(7-1/4")	20	15.88(5/8")	1.6	1.3	64	0	SMTCCG	Acero inoxidable Acero dulce	Hendidura Láser	1	B-31681

Cortadora de metal 12"



Diámetro exterior (mm)	Perforación (mm- In)	Anillo (mm)	Grosor (mm)	Base (mm)	Dientes	Rastrillo	Forma del diente	Material	Nota	Piezas empaque	No. parte
305(12")	25.4(1")		2.5	2.2	60	0	TCG	Acero dulce		1	A-90532
305(12")	25.4(1")		2.1	1.7	60	0	TCG	Acero dulce		1	B-33956
305(12")	25.4(1")		2.4	2.2	60	0	TCG	Acero dulce	Hendidura Láser	1	B-33962
305(12")	25.4(1")		2.3	2	78	-5	MTCG	Acero dulce delgado		1	B-33978
305(12")	25.4(1")		1.95	1.65	100	-3	SMTCCG	Acero inoxidable Acero dulce	Hendidura Láser	1	B-23145



Cortadora de metal 14"



Diámetro exterior (mm)	Perforación (mm- In)	Anillo (mm)	Grosor (mm)	Base (mm)	Dientes	Rastrillo	Forma del diente	Material	Nota	Piezas empaque	No. parte
355(14")	25.4(1")		2.2	1.8	70	0	TCG	Metal		1	B-51281
355(14")	25.4(1")		2.1	1.8	90	-5	MTCG	Metal suave		1	B-51297

Especializado para corte de MDF

Sierra circular

	Diámetro exterior (mm)	Perforación (mm- in)	Anillo (mm)	Grosor (mm)	Base (mm)	Dientes	Rastrillo	Forma del diente	Material	Nota	Piezas empaque	No. parte
	185(7-1/4")	30/1-3/16"	16-5/8" 20-3/4"	2.4	1.5	60	12	ATB	MDF		1	D-38934
	185(7-1/4")	20mm	16-5/8" 20-3/4"	2.2	1.5	60	12	ATB	MDF		1	D-59427
	185(7-1/4")	20mm	15.88mm (5/8")			60		TCG	MDF		10	NUEVO D-61466-10
	190mm (7-1/2")		15.88mm (5/8")	1.45	1	44		TCG	MDF	 7-1/2"	1	B-54461
	190mm (7-1/2")		15.88mm (5/8")	1.45	1	44		TCG	Madera	 7-1/2"	1	B-54477



Sierra de inglete compuesto/Sierra de inglete

	Diámetro exterior (mm- in)	Perforación (mm- in)	Anillo (mm)	Grosor (mm)	Base (mm)	Dientes	Rastrillo	Forma del diente	Material	Nota	Piezas empaque	No. parte
	255(10")	30/1-3/16"	15.88/5/8"	3	2	100	12	ATB	MDF		1	D-38940
	305(12")	30/1-3/16"	15.88/5/8"	3.2	2.2	120	12	ATB	MDF		1	D-38956



Especializado para fibro cemento

Sierra circular / Sierra de inglete

Permite cortar fibrocemento

	Diámetro exterior (mm-in)	Perforación (mm- in)	Anillo (mm)	Grosor (mm)	Base (mm)	Dientes	Rastrillo	Forma del diente	Material	Nota	Piezas empaque	No. parte
	185mm 7-1/4"	5/8"		1.6	1	28		ATB	Fibro-cemento	Para 5057NB	1	A-90451



Diente de diamante policristalizado

Permite cortar fibrocemento

	Diámetro exterior (mm)	Perforación (mm- in)	Grosor (mm)	Base (mm)	Dientes	Rastrillo	Forma del diente	Material	Piezas empaque	No. parte
	165mm (6-1/2")	15.88mm (5/8")	1.8	1.4	4	12°	PCD	Placas de fibrocemento	1	D-72023
	185mm (7-1/4")	15.88mm (5/8")	1.8	1.4	4	12°	PCD	Placas de fibrocemento	1	D-72039
	255mm (10")	15.88mm (5/8")	2.2	1.6	6	12°	PCD	Placas de fibrocemento	1	D-72045
	305mm (12")	15.88mm (5/8")	2.2	1.6	8	12°	PCD	Placas de fibrocemento	1	D-72051



NUEVO

Especializado para panel de sandwich

Sierra circular

	Diámetro exterior (mm-in)	Perforación (mm- in)	Anillo (mm)	Grosor (mm)	Base (mm)	Dientes	Rastrillo	Forma del diente	Material	Nota	Piezas empaque	No. parte
	165mm 6-1/2"	20mm	5/8"	1.75	1.4	42	0	SMTCCG	Panel de sandwich		1	B-63177



NUEVO

Hojas de sierra multipropósito



NUEVO

Sierra circular y sierra de inglete

	Diámetro exterior (mm)	Perforación (mm-In)	Diámetro interior Anillo (mm)	Grosor (mm)	Base (mm)	Dientes	Rastrillo	Forma del diente	Material	Nota	Piezas empaque	No. parte
	165mm (6-1/2")	30mm	15.88, 16 19,20	2.4	1.5	60	5	TCG	Aluminio,MDF, PVC madera comprimida	Para sierras circulares y sierras de inglete	1	D-63616
	185mm (7-1/4")	30mm	15.88, 16 20	2.2	1.5	60	5	TCG	Aluminio,MDF, PVC madera comprimida	Para sierras circulares	1	D-63622
	190mm (7-1/2")	30mm	15.88, 16 20	1.45	1	60	5	TCG	Aluminio,MDF, PVC madera comprimida	Para sierras circulares y sierras de inglete	1	D-63638
	210mm (8-1/4")	30mm	16,20,25,25.4	1.45	1	60	5	TCG	Aluminio,MDF, PVC madera comprimida	Para sierras circulares	1	D-63644
	216mm (8-1/2")	30mm	16,20,25,25.4	1.45	1	60	5	TCG	Aluminio,MDF, PVC madera comprimida	Para sierras de inglete	1	D-63650
	216mm (8-1/2")	30mm	16,20,25,25.4			80	5	TCG	Aluminio,MDF, PVC madera comprimida	Para sierras de inglete	1	D-63878
	235mm (9-1/4")	30mm	16,20,25,25.4			60	5	TCG	Aluminio,MDF, PVC madera comprimida	Para sierras circulares	1	D-63557
	260mm (10-1/4")	30mm	16,20,25,25.4			80	5	TCG	Aluminio,MDF, PVC madera comprimida	Para sierras de inglete y de inglete compuesto	1	D-63563
	260mm (10-1/4")	30mm	16,20,25,25.4	2.6	1.8	100	5	TCG	Aluminio,MDF, PVC madera comprimida	Para sierras de inglete y de inglete compuesto	1	D-62234
	260mm (10-1/4")	30mm	16,20,25,25.5			120	5	TCG	Aluminio,MDF, PVC madera comprimida	Para sierras de inglete y de inglete compuesto	1	D-62240
	305mm (12")	30mm	16,20,25,25.4			80	5	TCG	Aluminio,MDF, PVC madera comprimida	Para sierras de inglete y de inglete compuesto	1	D-63579
	305mm (12")	30mm	16,20,25,25.4			100	5	TCG	Aluminio,MDF, PVC madera comprimida	Para sierras de inglete y de inglete compuesto	1	D-63585
	305mm (12")	30mm	16,20,25,25.4			120	5	TCG	Aluminio,MDF, PVC madera comprimida	Para sierras de inglete y de inglete compuesto	1	D-63591
	355mm (14")	30mm	16,20,25,25.4			100	5	TCG	Aluminio,MDF, PVC madera comprimida	Para sierras de inglete	1	D-63884
	165mm (6-1/2")		15.88mm (5/8")			60	5	TCG	Aluminio,MDF, PVC madera comprimida	Para sierras de inglete y sierra circular	1	D-72475
	185mm (7-1/4")		15.88mm (5/8")			60	5	TCG	Aluminio,MDF, PVC madera comprimida	Para sierra circular	1	D-72481
	210mm (8-1/4")		15.88mm (5/8")			60	5	TCG	Aluminio,MDF, PVC madera comprimida	Para sierra circular	1	D-72497
	255mm (10")		15.88mm (5/8")			80	5	TCG	Aluminio,MDF, PVC madera comprimida	Para sierra de inglete	1	D-72506
	255mm (10")		15.88mm (5/8")			100	5	TCG	Aluminio,MDF, PVC madera comprimida	Para sierra de inglete	1	D-72512
	255mm (10")		15.88mm (5/8")			120	5	TCG	Aluminio,MDF, PVC madera comprimida	Para sierra de inglete	1	D-72528
	305mm (12")		25.4mm (1")			80	5	TCG	Aluminio,MDF, PVC madera comprimida	Para sierras de inglete y sierra circular	1	D-72534
	305mm (12")		25.4mm (1")			100	5	TCG	Aluminio,MDF, PVC madera comprimida	Para sierras de inglete y sierra circular	1	D-72540
	305mm (12")		25.4mm (1")			120	5	TCG	Aluminio,MDF, PVC madera comprimida	Para sierras de inglete y sierra circular	1	D-72556
	355mm (14")		25.4mm (1")			100	5	TCG	Aluminio,MDF, PVC madera comprimida	Para sierras de inglete y sierra circular	1	D-72562

Anillos reductores para hoja de sierra



Usar en	Eje disco	Reducción	Esesor	Empaque piezas	No. Parte
Hoja de sierra circular 10"	1"	5/8"		1	257060-5
Hoja de sierra circular 10"	1"	5/8"		1	257022-3
Hoja de sierra circular 10"	3/4"	5/8"	1.2mm	1	B-20987
Hoja de sierra circular 10"	3/4"	5/8"	1.8mm	1	B-20993
Hoja de sierra circular 10"	1-3/16"	5/8"	1.2mm	1	B-21004
Hoja de sierra circular 10"	1-3/16"	5/8"	1.8mm	1	B-21010
Hoja de sierra circular 10"	1-3/16"	3/4"	1.2mm	1	B-21026
Hoja de sierra circular 10"	1-3/16"	3/4"	1.4mm	1	B-21032

Usar en	Eje disco	Reducción	Esesor	Empaque piezas	No. Parte
Hoja de sierra circular 10"	1-3/16"	3/4"	1.8mm	1	B-21048
Hoja de sierra circular 10"	1-3/16"	25mm	1.6mm	1	B-21054
Hoja de sierra circular 10"	1-3/16"	1"	1.4mm	1	B-21060
Hoja de sierra circular 10"	1-3/16"	1"	2.2mm	1	B-21076

Cera lubricante para discos metálicos y sierras de banda

Facilita el corte al disminuir a resistencia entre los materiales

Tipo	Empaque piezas	No. Parte
BpB180, 2016, 2106W, 2107F Hoja de sierra con carburo de tungsteno y metálicos	Tubo 50gr.	191897-9



Accesorios para SP6000 / DSP600 / DSP601

Set de adaptadores para carriles de guía

*Usar con el conjunto de base de ensamblaje

Descripción	Para Modelo	No.Parte
 Guía recta p/ router	3612BR, RP0900, RP0910, RP1110C, RP1800/F, RP1801/F, RP2300FC, RP2302FC, *RT0700C, DTR50	194579-2
 Adaptador guía	HS6600	197462-2
 Adaptador guía de carril	HS0600	198570-2
 Adaptador guía	XVJ03, 4350T, DHS680, HS7600	197252-3
 Adaptador guía de carril	HS7600	197005-0
 Adaptador guía de carril	DHS680	196953-0
 Adaptador guía de carril	4100KB	198673-2

Reglas guía



Descripción	Para Modelo	No.Parte
Guía riel 1.5m	SP6000 / DSP600 / DSP601	199141-8

Juego de prensas

Descripción	No.Parte
 Juego de prensas	194385-5
 Juego de prensas	199826-6

Juego de rieles



Descripción	No.Parte
Juego de rieles para unir reglas guía	198884-9

Guía transportador para DSP600



Descripción	No.Parte
Guía transportador	196664-7

Reemplazos para reglas guía

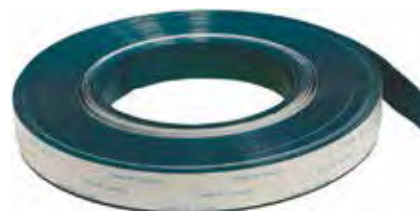

Deslizante 194416-0



Antideslizante 194417-8

Descripción	Tamaño	No.Parte
Reemplazo de vinil verde deslizante p/ regla guía	10 mts.	194416-0
Reemplazo de vinil negro antideslizante p/ regla guía	10 mts.	194417-8

El equipo estándar (accesorios), las especificaciones y las fotografías pueden variar. Los accesorios pueden no estar incluidos desde origen con las herramientas, aunque se indiquen en este catálogo.



SEGUETAS



Diente carburo de tungsteno



Corte curvo



Material delgado



Use refrigerante



Grano de diamante



Corte fino



Tipo de diente forma afilada



Tamaño del grano



Corte basto



Dientes por pulgada



Corte recto



Material grueso



No usar péndulo

Segueta

Diente tipo



Fabricación de dientes

Dientes fresados

- Bajo costo en el tipo de manufactura
- Para cortes en general
- Suave para materiales duros
- Larga vida de la segueta



Dientes Triscados

- Costo del tipo de manufactura
- Muy fuerte
- Corte preciso y limpio
- Suave para materiales de dureza media



Método de producción

- **Lateral:** Cada diente es alternado individualmente a la izquierda y a la derecha.
Ejemplo de configuración: derecha, izquierda, recta, etc.
- **Ondulado:** La fila de dientes tiene forma de onda
- **Triscado / Rectificado:** El cuerpo de la segueta se estrecha en la parte posterior (cónico)



Segueta

- **HCS (Acero al alto carbón)** para corte de materiales suaves como madera o plásticos.
- **HSS (acero de alta velocidad)** para corte de materiales duros tales como metales.
- **BiM (Bi-Metal, HCS base y dientes HSS)** para corte de materiales suaves a duros como madera, metal, plásticos.
- **TC (Carburo de tungsteno)** para corte de fibra de vidrio reforzada de plástico, planchas de fibrocemento o yeso.

Segueta - encastre tipo B

Para modelos:

DJV181, DJV182, DJV141, DJV142, BJV180, BJV140, JV183D, JV143D, JV0600, JV100D, DJR185, DJR145, JR102D, 4326, 4327, 4328, 4329, 4350T/CT/FCT, 4351T/CT/FCT



Sierra de calar super-express

Forma	No.	Madera contrachapada (mm)	Plásticos (mm)	Aluminio (mm)	Acero inoxidable (mm)	Acero dulce (mm)	Características de la aplicación	Longitud de trabajo (mm)	Dientes por In	Material	Tipo de corte	Piezas empaque	No. parte
	B-50	B-50	B-50	-	-	-	Para trabajos de acabado en madera y plástico	77	8.5 -10.6	HCS		5	B-06460
	B-51	-	-	-	1-3	1-8	Para cortes en acero dulce, acero inoxidable	77	9.8 -18.1	HSS		5	B-06476
	B-52	5-50	5-50	3-35	3-5	3-8	Para corte universal de materiales	77	5.5 -9.8	HSS		5	B-06482

Madera/ básico

Forma	No.	Madera contrachapada (mm)	Plásticos (mm)	Aluminio (mm)	Acero inoxidable (mm)	Acero dulce (mm)	Características de la aplicación	Longitud de trabajo (mm)	Dientes por In	Material	Tipo de corte	Piezas empaque	No. parte
	B-13	4-65	4-65	-	-	-	Para cortes en general	70	8	HCS		5	A-85656
	B-15	3-35	3-35	-	-	-	Ideal para corte de materiales delgados	50	12	HCS		5	A-85678
	B-14	2-35	2-35	-	-	-	Ideal para corte de materiales delgados	50	18	HCS		5	A-85662
	B-18	2-35	2-35	-	-	-	Para cortes curvos	45	14	HCS		5	A-85709



Madera/ corte rápido

Forma	No.	Madera contrachapada (mm)	Plásticos (mm)	Aluminio (mm)	Acero inoxidable (mm)	Acero dulce (mm)	Características de la aplicación	Longitud de trabajo (mm)	Dientes por In	Material	Tipo de corte	Piezas empaque	No. parte
	58	4-65	4-65	-	-	-	Para corte rápido	75	8	HCS		5	A-86577
	B-16	5-65	5-65	-	-	-	Para corte rápido y basto	75	6	HCS		5	A-85684
	B-17	5-60	5-60	-	-	-	Ángulo del gancho 2°	70	6	HCS		5	A-85690
	B-17	4-65	4-65	-	-	-	Ángulo del gancho 2°	75	8	HCS		5	A-85232









Madera/ finalización

Forma	No.	Madera contrachapada (mm)	Plásticos (mm)	Aluminio (mm)	Acero inoxidable (mm)	Acero dulce (mm)	Características de la aplicación	Longitud de trabajo (mm)	Dientes por In	Material	Tipo de corte	Piezas empaque	No. parte
	B-17	4-65	4-65	-	-	-	Para trabajo de corte rápido y limpio	75	8	HCS		5	A-86583
	B-10	3-65	3-65	-	-	-	Para trabajo de acabado, especialmente en triplay	75	9	HCS		5	A-85628
	B-12	5-65	5-65	-	-	-	Trabajos de acabado en madera y plásticos	75	6	HCS		5	A-85640
	L-1	5-90	5-90	-	-	-	Ideal para cortes de materiales delgados	100	6	HCS		5	A-86290
	B-29	2-35	2-35	-	-	-	Para cortes curvos	42	16	HCS		5	A-80400
	BR-13	5-65	-	-	-	-	Cortes en madera que no requieren ser lijados	64	9	HCS		5	A-85793

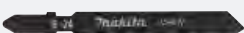

Corte limpio de madera

Forma	No.	Madera contrachapada (mm)	Plásticos (mm)	Aluminio (mm)	Acero inoxidable (mm)	Acero dulce (mm)	Características de la aplicación	Longitud de trabajo (mm)	Dientes por In	Material	Tipo de corte	Piezas empaque	No. parte
	B-19	3-50	3-50	-	-	-	Dientes reversibles para cortes libres de astillas. Para plásticos duros y chapas decorativas	65	12	HCS		5	A-85715

Metal/ básico

Forma	No.	Madera contrachapada (mm)	Plásticos (mm)	Aluminio (mm)	Acero inoxidable (mm)	Acero dulce (mm)	Características de la aplicación	Longitud de trabajo (mm)	Dientes por In	Material	Tipo de corte	Piezas empaque	No. parte
	51	-	1.5-6	1.5-6	1-3	1-3	Para acero dulce	65	24	HSS		5	A-86561
	B-22	-	1-6	1-3	1-3	1-3	Para acero dulce, plásticos duros especialmente para lámina delgada de metal	50	24	HSS		5	A-85737
	B-24	-	1-3	1-2	0.5-2	0.5-2	Para metal muy delgado	50	32	HSS		5	A-85759
	B-23	3-35	3-35	2-6	-	2-6	Chapas decorativas, láminas de metal de grosor medio	50	14	HSS		5	A-85743
	B-27	-	1-6	1-3	1-3	1-3	Para cortes curvos en acero dulce	50	24	HSS		5	A-85787

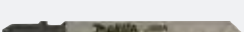

Para MDF

Forma	No.	Madera contrachapada (mm)	Plásticos (mm)	Aluminio (mm)	Acero inoxidable (mm)	Acero dulce (mm)	Características de la aplicación	Longitud de trabajo (mm)	Dientes por In	Material	Tipo de corte	Piezas empaque	No. parte
	P	3-20	3-20	-	-	-	Especial para MDF y triplay larga vida	63	16	HSS	Recto	5	B-28709
	B-29	3-6	3-6	-	-	-	Especial para MDF y triplay	42	16	HSS	Curvo	5	B-28715
	B-28	3-20	3-20	-	-	-	Especial para MDF, triplay y madera enchapada corte fino	63	16	HSS	Recto	5	B-28721

Juego de seguetas Makita

Super cuchillo para sierra de calar



Tipo	Diferentes hojas de sierra de calar en un solo paquete						Piezas empaque	No. parte
 Tipo B	B-10S	B-13	B-16	B-22	B-23		5	A-86898
 Tipo B	B-50	B-51	B-52	-	-		3	B-06292
 Tipo B	B-50x2	B-51	B-52	B-53	-		5	B-48527

Para maderas básicas normales (línea estándar)

Para modelos:

DJV181, DJV182, DJV141, DJV142, BJV180, BJV140, JV183D, JV143D, JV0600, JV100D, DJR185, DJR145, JR102D, 4326, 4327, 4328, 4329, 4350T/CT/FCT, 4351T/CT/FCT







Forma	Madera contrachapada (mm)	Plásticos (mm)	Aluminio (mm)	Acero inoxidable (mm)	Acero dulce (mm)	Características de la aplicación	Longitud de trabajo (mm)	Dientes por In	Material	Tipo de corte	Piezas empaque	No. parte
	4-50	-	-	-	-	Madera /Básico	74	8	HCS		5	D-34877
	4-50	-	-	-	-	Madera / corte rápido	74	6	HCS		5	D-34883

El equipo estándar (accesorios), las especificaciones y las fotografías pueden variar. Los accesorios pueden no estar incluidos desde origen con las herramientas, aunque se indiquen en este catálogo.







Para maderas básicas normales (línea estándar)

Para modelos:

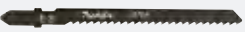

DJV181, DJV182, DJV141, DJV142, BJV180, BJV140, JV183D, JV143D, JV0600, JV100D, DJR185, DJR145, JR102D, 4326, 4327, 4328, 4329, 4350T/CT/FCT, 4351T/CT/FCT

Forma	Madera contrachapada (mm)	Plásticos (mm)	Aluminio (mm)	Acero inoxidable (mm)	Acero dulce (mm)	Características de la aplicación	Longitud de trabajo (mm)	Dientes por In	Material	Tipo de corte	Piezas empaque	No. parte
	4-50	-	-	-	-	Madera / corte rápido, curvo	74	6	HCS		5	D-34899
	-	-	-	-	1-3	Metal / Básico		21	HSS		5	D-34908
	4-50	-	-	-	-	Madera / finalización	74	9	HCS		5	D-72718

Para plásticos y aluminios

Forma	No.	Madera contrachapada (mm)	Plásticos (mm)	Aluminio (mm)	Acero inoxidable (mm)	Acero dulce (mm)	Características de la aplicación	Longitud de trabajo (mm)	Dientes por In	Material	Tipo de corte	Piezas empaque	No. parte
	B-21	-	3-60	1-10	-	-	Para trabajos de acabado en plásticos y aluminio	75	12	HSS		5	A-85721
	B-25	3-60	3-60	3-6	-	3-6	Para madera dura, hojas delgadas de acero dulce y plásticos duros, aluminio	75	9	HSS		5	A-85765
	B-26	3-60	3-60	3-10	-	3-10	Para cortes curvos madera dura y plásticos duros, aluminio	70	9	HSS		5	A-85771

Para cemento de fibra

Forma	No.	Madera contrachapada (mm)	Plásticos (mm)	Aluminio (mm)	Acero inoxidable (mm)	Acero dulce (mm)	Características de la aplicación	Longitud de trabajo (mm)	Dientes por In	Material	Tipo de corte	Piezas empaque	No. parte
	B-60		-	-	-	-	Fibrocemento/yeso 5-50, FRP/plástico 5-20	75	6	TC	-	3	B-06890
	B-61		-	-	-	-	Fibrocemento/yeso 5-80, FRP/plástico 5-50	105	6	TC	-	3	B-06909



Sierra Caladora

Para madera, metal, universal y laminado

Tipo	No.	Madera contrachapada (mm)	Aplicación	Material del diente	Piezas empaque /No. pieza	No. parte
	B-50	77	Para corte rápido/ fino madera	HCS	4 B-064640	B-44426
	B-51	77	Para corte rápido metal	HSS	2 B-06476	
	B-52	77	Para corte rápido universal	HSS	2 B-06482	
	B-53	60	Para corte fino laminado	Bi-Metal	2 B-10970	

Segueta para sierra reciproca





Corte de metales y plásticos

Tipo	Dientes por In	Longitud total	Aplicación	Material	Piezas empaque	No. parte
	18 TPI	6-5/16"	Para corte en placa de acero de más de 3mm de espesor, tubo de hierro de 90mm ó menor	HCS	2	B-00810
	24 TPI	160mm	Placa de acero de 3mm ó menor, tubo de hierro de 50mm ó menor	HCS	2	B-00832



Seguetas para sierra recíproca

Para modelo: JR100D, JR102D

Para acero

Tipo	Dientes por In	Longitud total	Aplicación	Material	Piezas empaque	No. parte
	24	100(4")	Para metal de espesor de 0.7-3.0mm.	Bi-Metal	5	B-20395
	18	100(4")	Para metal de espesor de 1.5-4.0mm.	Bi-Metal	5	B-20404
	14	100(4")	Para metal de espesor de 3.0-8.0mm	Bi-Metal	5	B-20410
	24 TPI Acero al alto carbón	100(4")	Corte de lámina de acero hasta 3mm de espesor	(HCS)	2	B-00804

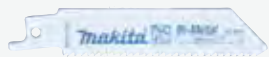

Para madera y acero

Tipo	Dientes por In	Longitud total	Aplicación	Material	Piezas empaque	No. parte
	10	100(4")	Para lámina de metal de 3.0-12.0mm, madera de 10.0-50.0mm	Bi-Metal	5	B-20426
	14-18	100(4")	Para metal de espesor de 3.0-8.0mm, madera de 10.0-50.0mm	Bi-Metal	5	B-20454

Para madera con clavos

Tipo	Dientes por In	Longitud total	Aplicación	Material	Piezas empaque	No. parte
	6	100(4")	Para madera con clavos 10.0mm-50.0mm	Bi-Metal	5	B-20432

Para cartón yeso * Para JR300







Tipo	Dientes por In	Longitud total	Aplicación	Material	Piezas empaque	No. parte
	6	100(4")	Para tablaroca 5.0-50.0mm	Bi-Metal	5	B-20448
	Varios	100(6")	Juego combinado	Bi-Metal	3	792003-5 *

Sierra recíproca

Para modelo:

JR140D, JR180D, BJR141, BJR181, BJR182, BJR240, JR3050T, JR3060T, JR3070CT

Para acero / metal / básicas

Tipo	Dientes por In	Longitud total (mm)	Aplicación	Material	Piezas empaque	No. parte
	18	152 (6")	Corte de metal 1.5-4mm, tubería 5-100mm	Bi-Metal	2	D-51633
	24	152 (6")	Corte de metal 0.7-3mm, tubería 5-100mm	Bi-Metal	2	D-51649
	18	255 (9")	Corte de metal 1.5-4mm, tubería 5-175mm	Bi-Metal	2	D-51661
	24	255 (9")	Corte de metal 1.7-3mm, tubería 5-175mm	Bi-Metal	2	D-51677
	14	152 (6")	Corte de metal 1.5-4mm, tubería 5-100mm	Bi-Metal	25	D-51627-25
	18	152 (6")	Corte de metal 1.5-4mm, tubería 5-100mm	Bi-Metal	25	D-51633-25



El equipo estándar (accesorios), las especificaciones y las fotografías pueden variar. Los accesorios pueden no estar incluidos desde origen con las herramientas, aunque se indiquen en este catálogo.

Sierra recíproca

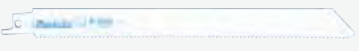

Para madera / básicas

Tipo	Dientes por in	Longitud total (mm)	Aplicación	Material	Piezas empaque	No. parte
	6 TPI Bi-Metal (Bim)	150(6")	Cortes rápidos y trabajos preparativos generales en madera	HCS	2	D-53089

Para madera con clavos / Industrial

Tipo	Dientes por in	Longitud total (mm)	Aplicación	Material	Piezas empaque	No. parte
	10	225 (9")	Para tarimas, madera con clavos 5-100mm, hojas de metal, tubos, perfiles de aluminio 3-12mm, plástico	Bi-Metal	5	B-31859
	10-14	152 (6")	Corta metal, aluminio (3-10mm), pvc, madera c/clavos (5-100mm)	Bi-Metal	5	B-43240
	10-14	225 (9")	Corta metal, aluminio (3-10mm), pvc, madera c/clavos (5-175mm)	Bi-Metal	5	B-43262

Segueta sable flexible // Corte rápido, Para metal, larga vida / Industrial

Tipo	Dientes por in	Longitud total (mm)	Aplicación	Material	Piezas empaque	No. parte
	14-18	152 (6")	Corte de metal	Bi-Metal	5	B-55815
	14-18	225 (9")	Corte de metal	Bi-Metal	5	B-55821
	14-18	305 (12")	Corte de metal	Bi-Metal	5	B-55837



Segueta sable flexible // Metal / Industrial

Tipo	Dientes por in	Longitud total (mm)	Aplicación	Material	Piezas empaque	No. parte
	10-94	255 (9")	Corte de metal 2-10mm, tubería 175mm	Bi-Metal	2	B-43197-2 NUOVO
					5	B-43197

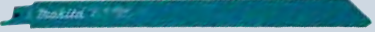
Para acero / profesionales



Tipo	Dientes por in	Longitud total (mm)	Aplicación	Material	Piezas empaque	No. parte
	18	152 (6")	Para lámina de acero 1.5mm-3.0 mm. Para tubo de hierro de 100 mm de diám. o menos.	Bi-Metal	2	B-05169-2 NUOVO
5					B-05169	
25					B-05169-25	
	24	255 (9")	Corte de metal 0.7-3mm, tubería 5-175mm	Bi-Metal	2	B-43169-2 NUOVO
5					B-43169	

Segueta sable para aluminio



Tipo	Dientes por in	Longitud total (mm)	Aplicación	Material	Piezas empaque	No. parte
	6	152 (6")	Para madera con clavos 10mm-100mm, fibra de vidrio 8-50mm, PVC, aluminio	Bi-Metal	5	B-05175
	18	165 (6-1/2")	Para lámina de acero, aluminio 3.0mm-5.0mm. Para tubo de hierro de 90 mm de diám. o menos	HSS	5	792147-1

Sierra recíproca

Segueta sable para poliuretano, hule espuma

Tipo	Dientes por In	Longitud total (mm)	Aplicación	Material	Piezas empaque	No. parte
	1.5mm	6"	Para poliuretano y hule espuma	HCS	1	B-52118
	1.5mm	9"	Para poliuretano y hule espuma	HCS	1	B-52124
	1.5mm	12"	Para poliuretano y hule espuma	HCS	1	B-52130

Juegos de seguetas

Tipo	Dientes por In	Longitud total (mm)	Aplicación	Material	Piezas empaque	No. parte empaque	No. parte
Para madera y madera con clavos (profesionales) 	6-10	6"	Para corte rápido (super express) madera		2	B-05153	B-44432
		6"	Para corte básico madera		2	B-16798	
		6"	Para madera con clavos		2	B-05175	
Para metal, universal (Profesionales) 		6"	Para corte rápido (super express) universal		2	B-05044	B-44448
		9"	Para corte básico metal		2	B-16776	
	18	228mm (9")	Para corte básico metal		2	B-16782	
Para madera con clavos (Básica) 	Variado	152	Corta metal, madera juego c/ porta seguetas	Bi-Metal HCS	2	D-53089	D-53051
					2	D-51627	
					2	D-51633	

Sierra recíproca



Para modelo:

JR140D, JR180D, BJR141, BJR181, BJR182, BJR240, JR3050T, JR3060T, JR3070CT

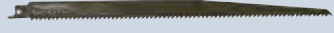
Segueta para sierra sable super express /Fast cut / Profesionales

Tipo	Dientes por In	Longitud total (mm)	Aplicación	Material	Piezas empaque	No. parte
	7-18	152(6")	(hierro/acero 1.5-8.0mm, plástico 5-77mm) Para corte rápido de metal (hierro/acero 1.5-8.0mm, plástico 5-77mm)	Bi-Metal	2	B-05038-2 NUEVO
					5	B-05038
					25	B-05038-25
	6-11	152(6")	Corte rápido para metal no-ferroso, aluminio, plásticos, madera con clavo, acero (hierro/acero 5-8mm, plástico 5-77mm, madera 5-77mm)	Bi-Metal	2	B-05044-2 NUEVO
					5	B-05044
					25	B-05044-25

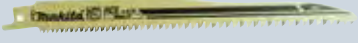
Segueta para sierra sable super express /Fast cut / Profesionales

Tipo	Dientes por In	Longitud total (mm)	Aplicación	Material	Piezas empaque	No. parte
	6-10	203(8")	Corte rápido para madera	HCS	2	B-05153-2 NUEVO
					5	B-05153
					25	B-05153-25
	18	225mm	Para corte básico metal	Bi-Metal	2	B-16782-2 NUEVO
					5	B-16782
					25	B-16782-25
	24	225mm	Para metal y tubería delgada	Bi-Metal	2	B-16835-2 NUEVO
					5	B-16835

El equipo estándar (accesorios), las especificaciones y las fotografías pueden variar.
Los accesorios pueden no estar incluidos desde origen con las herramientas, aunque se indiquen en este catálogo.

Sierra recíproca

Para modelo:

JR140D, JR180D, BJR141, BJR181, BJR182, BJR240, JR3050T, JR3060T, JR3070CT

Para metal / básica

Tipo	Dientes por In	Longitud total (mm)	Aplicación	Material	Piezas empaque	No. parte
NUEVO 	14	152	Para placas de metal de 3-8mm, tubo de 10-100mm	BiM	2	B-16841-2
	14	225	Para placas de metal de 3-8mm, tubo de 10-175mm	BiM	2	B-16776-2
	10-14	305	Para tubos de metal de 5 a 200mm, aluminio y plástico de 5-20mm	BiM	2	B-16857-2

Para metal pesado

Tipo	Dientes por In	Longitud total (mm)	Aplicación	Material	Piezas empaque	No. parte
NUEVO 	8+10	225	Para chapa gruesa 4-12mm, tubo <175mm (fast cut)	BiM	2	B-43181-2
	8+10	305	Para chapa gruesa 4-12mm, tubo <250mm (fast cut)	BiM	2	B-43212-2

Para madera -básica / madera y metal

Tipo	Dientes por In	Longitud total (mm)	Aplicación	Material	Piezas empaque	No. parte
NUEVO 	6	305	Paramadera blanda, aglomerado, contrachapado con núcleo de madera <250mm	HCS	2	B-16829-2
	5-8	225	Para madera con metal, aglomerado 10-175mm	BiM	2	B-43256-2
	5-8	305	Para madera con metal, aglomerado 10-235mm	BiM	2	B-43278-2

Para material congelado (carne, hueso y cuerno)

Tipo	Dientes por In	Longitud total (mm)	Aplicación	Material	Piezas empaque	No. parte
	3	305(12")	Para material congelado (Carne) 10-250 mm	Acero inoxidable	1	B-10609
	6	152(6")	Para material congelado (Carne) 10-80 mm	Acero inoxidable	1	B-52043
	6	228(9")	Para material congelado (Carne) 10-175 mm	Acero inoxidable	1	B-30564
	6	305(12")	Para material congelado (Carne) 10-250 mm	acero inoxidable	1	B-23248
	10	228(9")	Para material congelado (Carne) 10-175 mm	acero inoxidable	1	B-30570
	10	305(12")	Para material congelado (Carne) 10-250 mm	acero inoxidable	1	B-23254

Para uso especial

Tipo	Dientes por In	Longitud total (mm)	Aplicación	Material	Piezas empaque	No. parte
	-	152	Para lámina de acero inoxidable 2mm-4mm, tubo de acero inoxidable 50mm diám. o menos, fibra de vidrio	TC/HM	2	B-07250
	-	200	Tubo de acero inoxidable diámetro de hasta 3"	TC/HM	2	B-51312
	-	228	Tubo de acero fundido 150mm diámetro o menos para ladrillo rojo 10-175mm, FRP / epoxico 3-175mm	Grano de diamante	2	B-31871

Para bambú y rama verde

Tipo	Dientes por In	Longitud total (mm)	Aplicación	Material	Piezas empaque	No. parte
NUEVO 	8.5	190	Para ramas verdes, bambú; corte limpio	HCS	1	B-56580
	15	190	Para ramas verdes, bambú; corte limpio	HCS	1	B-56596
	8.5	225	Para ramas verdes, bambú; corte limpio	BiM	1	B-57386
	15	225	Para ramas verdes, bambú; corte limpio	BiM	1	B-57392
	8.5	250	Para ramas verdes, madera; corte limpio	HCS	1	B-62016

Para concreto aereado



Tipo	Dientes por In	Longitud total (mm)	Aplicación	Material	Piezas empaque	No. parte
NUEVO 	3	305 (12")	concreto aereado, ladrillos, arenisca, yeso	TC /HM	2	B-63585
	2	400 (16")	concreto aereado, ladrillos, arenisca, yeso	TC /HM	2	B-63591

Corte de ladrillo

Tipo	Dientes por In	Longitud total (mm)	Aplicación	Material	Piezas empaque	No. parte
	2	12"	Para ladrillo, tabique y mampostería	TCT	1	B-10394
	2	18"	Para ladrillo, tabique y mampostería	TCT	1	B-10403

Para tablaroca

Especial para SD140D / SD180D

Tipo	Dientes por In	Longitud total	Aplicación	Espesor	Piezas empaque	No. parte
	4	2"	Para tablaroca	0.55	2	B-49703
	4	2"	Para madera	0.55	2	B-49719

Cinta para sierra de banda

NUEVO

Diente de honda

Medida	Dientes por In	Tipo	Aplicación	Piezas empaque	Parte No.
730x13x0.5mm	14	BiM	Acero inoxidable metales no ferrosos	5	E-04101
730x13x0.5mm	18	BiM	Acero inoxidable metales no ferrosos	5	E-04117
730x13x0.5mm	24	BiM	Acero inoxidable metales no ferrosos	5	E-04123



Cinta para sierra de banda

Ancho: 13mm Grosor: 0.5mm Longitud: 1,140mm
Para modelo: BPB180, 2106, 2107F, XBP01



Diente de honda
Material: **BiM**

Tipo	Espesor de la pieza de trabajo	Dientes por In	Aplicación	Piezas empaque	Parte No.
Acero al carbón	32-7/8"x1/2"	18	metal P/ PB181B XBP01	5	B-40559
Acero al carbón	32-7/8"x1/2"	24	metal P/ PB181B XBP01	5	B-40565

Cinta para sierra de banda

Espesor: 0,5mm
Material: **HCS**

Para modelo: LB1200F

Ancho (mm)	Dientes por In	Aplicación	Piezas empaque	Parte No.
88x16	4	Madera / para corte cruzado	3	B-16667
88x13	4	Madera / para corte universal	3	B-16673
88x6	6	Madera / para corte curvo	3	B-16689
88x16	14	Metal no ferroso	3	B-16695



Cinta para sierra de banda

Ancho: 13mm Grosor: 0.5mm Longitud: 1,140mm
Para modelo: BPB180, 2106, 2107F, XBP01, XBP02

Diente de honda
Material: **BiM HCS**

Tipo	Medida	Dientes por In	Aplicación	Parte No.
Acero al carbón (juego de 3 piezas)	44-7/8" x 1/2"	18	Plásticos y metal no ferroso, acero dulce, acero fundido, hierro fundido p/ XBP02	792559-8
Acero al carbón (juego de 5 piezas)	32-7/8" x 1/2"	14	metal P/ PB181B, XBP01	B-40543
BiM (1 pz por empaque)	44-7/8" x 1/2"	10	Acero inoxidable, metal P/ PB002G	NUEVO B-30128



Seguetas para caladora de banco SJ401

Para madera

Longitud	Diente	Material	Empaque piezas	No. Parte
5"	15 x in.	Madera	A granel	351011-000
5"	18 x in.	Madera y plástico	6 pzs.	722100-A
5"	15 x in.	Madera y plástico	6 pzs.	722101-A
5"	12 x in.	Madera y plástico	12 pzs.	722102-A
5"	11 x in.	Madera y plástico	12 pzs.	722103-A

El equipo estándar (accesorios), las especificaciones y las fotografías pueden variar.
Los accesorios pueden no estar incluidos desde origen con las herramientas, aunque se indiquen en este catálogo.

Abrazadera de segeta

(Para uso de hojas de vástago de 6,35 mm)



Modelo No.	No. Parte
4300BA, 4300BV	132276-260

Conector para aspiradora

Cabeza para aspiradora



Modelo No.	No. Parte
4331D, 4333D, 4334D	192547-9

Protector

(cubierta transparente delante de la hoja)



Modelo No.	No. Parte
4331D, 4333D, 4334D	415887-1

Guía paralela

Guía de inclinación

A: regla de guía y set de reglas circulares



B: Regla de guía



C: Guía circular de ensamblaje



Modelo No.	Tipo	No. Parte
4300BA, 4300BV	B	164113-2
4326/M, 4327/M, 4328, 4329, JV0600	A	192732-4
4300BA, 4300BV, 4301SB	C	123030-5

Placas de acrílico anti-astillas

(para cortes más limpios)

Evita el astillamiento de la madera al cortar con caladora

(Paquete de 5 piezas)

Modelo No.	No. Parte.
4326, 4327, 4328	192733-2
4323	416477-3



Base para caladora



Modelo No.	No. Parte
4331D, 4333D, 4334D	413068-1
4304	344443-9

Cuchillas para cizallas

	Aplicación	Para	Empaque Pieza	No. Parte
	Ensamble del cabezal de corte	JS1300	1	125112-9
	Cabezal de corte (Completo)	JS8000	1	125354-5
	Cuchilla central	BJ5130	1	725094-1
	Cuchilla central	BJ5161, JS1660, JS1601	1	792534-4
	Cuchilla central	JS1300	1	792744-3
	Cuchilla central	JS1670	1	792537-8
	Cuchilla central	JS8000	1	725129-8
	Cuchilla derecha	BJ5130	1	725092-5
	Cuchilla derecha	JS1300	1	792742-7
	Cuchilla izquierda	BJ5130	1	725093-3
	Cuchilla izquierda	JS1300	1	792743-5
	Cuchilla lateral	JS8000	1	725130-3
	Juego de cuchillas	JS1600, JS1602		191383-0
	Juego de cuchillas	JS1670	Juego 2 piezas	792536-0
	Juego de cuchillas	JS3200, JS3201	Juego 2 piezas	792287-5
	Juego de cuchillas	BJ5161, JS1660, JS1601	Juego 2 piezas	792533-6

Punzones para roedoras

	Tipo	Para	Empaque Pieza	No. Parte
	Punzón	JN1600, JN1602	1	792265-5
	Punzón	JN3200, JN3201	1	792728-1
	Punzón de repuesto	JN1601	1	A-83951

Matriz para roedoras

	Tipo	Para	Empaque Pieza	No. Parte
	Matriz	JN3200, JN3201	1	792292-2
	Soporte de punzón	JN1601	1	A-15051

Calibrador de cuchillas



Tipo	Para	Empaque Pieza	No. Parte
Calibrador de cuchillas	JS1650	1	762013-6
Calibrador de cuchillas	JS3200	1	762007-1

Cuchillas para cortadora de varilla



Descripción	Aplicación	Empaque Pieza	No. Parte
Cuchillas para cortador de varilla CT	Repuestos para cortadora de varilla SC161	Juego de cuchillas y tornillos de sujeción	SC00000111
Cuchillas para cortador de varilla HSS	Repuestos para cortadora de varilla SC161	Juego de cuchillas y tornillos de sujeción	SC00000160
Cuchillas para cortador de varilla	Repuestos para cortadora de varilla DSC250	Juego de cuchillas y tornillos de sujeción	SC09003260
110mm x 15mm 24 dientes	Repuestos para cortadora de varilla DSC250	Juego de cuchillas y tornillos de sujeción	E-11097



Cizalla inalámbrica
DJS161

Accesorios para cepillos

Cuchillas



Tipo	Usar en	Medida	Características	Empaque Pieza	No. Parte
Acero rápido	1100,1100NH, N1900B,1902	82 mm	Juego de dos cuchillas afilables.	1	D-16346
Carburo de tungsteno	1100,1100NH, N1900B,1902	82 mm	Juego dos cuchillas de repuesto	1	D-07945
Carburo de tungsteno	1100,1100NH, N1900B,1902	82 mm	Juego de dos cuchillas con cabeza reemplazable	1	D-07951
Carburo de tungsteno	1100,1100NH, N1900B,1902	82 mm	Juego de dos cuchillas tipo pulir, afilable.	1	D-07967
NUEVO HSS	KP0810C,KP0810 1100,KP0800, N1923B,N1900B, DKP140,DKP180	82 mm	Juego dos cuchillas de repuesto	1	D-72207
NUEVO HSS	1911B, 1912B	110 mm	Juego dos cuchillas de repuesto	1	D-71211
NUEVO HSS	1804N	136 mm	Juego dos cuchillas de repuesto	1	D-71227
NUEVO HSS	1805N	155 mm	Juego dos cuchillas de repuesto	1	D-70910
Acero rápido	1050DWAE	50 mm.	Juego de dos cuchillas afilables.	1	A-85400
Acero rápido	1600	3-1/8" (80 mm)	Juego de dos cuchillas afilables.	1	D-65501
Carburo de tungsteno	KP3125	312mm.	Juego de dos cuchillas reemplazables.	1	B-02864
Carburo de tungsteno	2030S	321mm.	Juego de dos cuchillas reemplazables.	1	B-02870
Acero rápido	1804N	136mm	Juego de dos cuchillas afilables.	1	793011-9
Carburo de tungsteno	2012NB	12" (305mm)	Juego de dos cuchillas reemplazables.	1	793346-8
Carburo de tungsteno	1805N	6-1/8"	Juego de dos cuchillas afilables.	1	793015-1

Porta cuchillas



Usar en	Medida	Características	Empaque Piezas	No. Parte
1912B	4-3/8"	Sujeción de cuchillas de repuesto	1	123062-2
1805B	6-1/8"	Sujeción de cuchillas de repuesto	1	123009-6

Calibrador de cuchillas



Usar en	Características	Empaque piezas	No. Parte
N1900B	Calibrador de cuchillas	1	127669-6

Soporte para afilado



Usar en	Medida	Características	Empaque piezas	No. Parte
1912B	4-3/8"	Soporte para afilar cuchillas para cepillo	1	123055-9
N1900B	82mm	Soporte para afilar cuchillas para cepillo	1	123004-6

Guías de cepillo



Usar en	Tipo	Características	Empaque Piezas	No. Parte
1805N	Guías paralela	Guías para cepillo	1	191454-3
1902	Guías paralela	Guías para cepillo	1	191455-1
1900B	Guías de nivel	Guías para cepillo	1	123060-6
1805B	Guías de nivel	Guías para cepillo	1	123053-3

Piedra para afilado



Usar en	Medida	Características	Empaque Piezas	No. Parte
Cuchillas de acero de alta velocidad	180x70x 20mm	Piedra para afilado de cuchillas para cepillo grano 1200	1	794060-9

Boquilla para N1900B

NUEVO



Larga vida útil: Fabricada con materiales durables

Usar en	Características	Empaque piezas	No. Parte
Cepillo N1900B	Se conecta fácilmente al cepillo y/o a la bolsa de polvo	1	191569-6

Llaves para herramientas

	Tipo	Usar en	Medidas	Para modelo	No. Parte
	Llave allen	Ajuste de tornillos hexagonales	3mm	JN3200,JS1600, JS1660,JS1670,4331D, 4333D,4334D,4300BA, 4300BV,4326/M,4327/ M,4328, 4329,JV0600	783201-2
	Llave allen	Ajuste de tornillos hexagonales	4mm	Desbrozadora de mochila EBH340R	060040000N
	Llave allen	Ajuste de tornillos hexagonales	4mm.	JS3200,4350T/CT/FCT, 4351T/CT/FCT,BJV140, BJV180,1806B,N1923B, 1911B	783202-0
	Llave allen	Ajuste de tornillos hexagonales	5mm.	Desbrozadora RBC411	0717059990
	Llave allen	Ajuste de tornillos hexagonales	5mm.	2711,2708W,5740NB, 5044KB, 4101RH	783203-8 782425-7
	Llave allen	Ajuste de tornillos hexagonales	6mm.	HM1211	783204-6
	Llave allen	Ajuste de tornillos hexagonales	8mm.	HM1500	783207-0
	Llave allen	Ajuste de tornillos hexagonales	10mm.	HM1211B	783210-1 SC00000165
	Llave Hex.	Ajuste de tornillos hexagonales	4mm.	Desbrozadora RBC413U, RBC414U	783223-2
	Llave hexagonal	Ajuste de tornillos hexagonales	23mm.	RD1100,RD1101, RF1100,RF1101	781031-5
	Llave hexagonal	Ajuste de tornillos hexagonales	13mm.	5057KB,5277B, 5077B,5177B	782016-4
	Llave hexagonal	Ajuste de tornillos hexagonales	13-22mm.	2702,2703	782021-1
	Llave de contratuercas con pernos	Bridas de apriete	20mm.	3901,9500N, 9523NBH,LXJP02, PC1100, PJ7000	782401-1
	Llave de dado hexagonal	Apriete de tornillos	13mm.	Desbrozadora de mochila EBH340R	060000015N
	Llave hexagonal p/Bujía	Ajuste de tornillos hexagonales	3/4" X 5/8"	Desbrozadora de mochila EBH340R	XNR0000085
	Llave de dado hexagonal	Apriete de tornillos	13mm.	EM4250	6249000000
	Llave de dado hexagonal	Apriete de tornillos	13mm.	EF1550RH	6909093000
	Llave de dado hexagonal	Apriete de tornillos	22mm.	MT410	781041-2
	Llave de dado hexagonal	Apriete de tornillos	9mm.	2012, 2012NB	782203-5
	Llave de dado hexagonal	Apriete de tornillos	6mm.	4200H, 5005BA	782209-3
	Llave de dado hexagonal	Apriete de tornillos	17mm.	2414NB,4100C, 4112H,BBC231U, BC231UD,BC300LD, HML01,LC1210, LC1230,MLC140, MLC141,MT240	782210-8
	Llave de dado hexagonal	Apriete de tornillos	17mm.	2414NB,4100C, 4112H,BBC231U, BC231UD,BC300LD, HML01,LC1210, LC1230,MLC140, MLC141,MT240	782210-8
	Llave de dado hexagonal	Para Instalación de discos de sierra	13mm.	Todas las sierras angulares y compuestas Makita	782212-4
	Llave española	Apriete de tornillos	8 x 10mm.	Desbrozadora de mochila EBH340R	302040600N
	Llave española	Apriete de tornillos	10mm.	3700D,906H,GE0600	781036-5
	Llave española	Apriete de tornillos	13mm.	3621,MRP090,RP0900, UT1301,UT1305, UT2204 GD0600	781006-4
	Llave española	Apriete de tornillos	16mm (5/8")	Rebajadora 3706, pulidora 9217SPC	781008-0
	Llave española	Apriete de tornillos	10mm	2708W,4200H,5077B, 5201NA,5402A,4101RH	781011-1
	Llave española	Apriete de tornillos	19mm	2702, 2703	781027-6
	Llave española	Apriete de tornillos	24mm	Router 3612B,3612C	781030-7
	Llave española	Apriete de tornillos	19mm	GD0800,GD0810C	781206-6
	Llave española	Apriete de tornillos	8mm	3612BR,3620	781213-9
	Llave inglesa	Tuerca de seguridad	50mm	JN3200	781019-5
	Llave inglesa	Tuerca de seguridad	32mm	JN1601	781028-4
Llave para tuerca de seguridad	Tuerca de seguridad	35mm.	HR3851	782034-2	
Llave para pernos	Para bridas		Esmeriladoras angulares 7" y 9"	782412-6	
Llave para pernos	Para bridas		Esmeriladoras angulares 4-1/2"	782420-7	
Llave para pernos	Para bridas		Esmeriladoras angulares 4-1/2"	782424-9	
Llave torx	Para tornillos		DCS3501, DCS4301, DCS460, DCS520, DCS5000, DCS5030, DCS6400, DCS6401, DCS7300, DPC6400, DPC7311, DPC7331, EA4300F	940827000	

El equipo estándar (accesorios), las especificaciones y las fotografías pueden variar. Los accesorios pueden no estar incluidos desde origen con las herramientas, aunque se indiquen en este catálogo.



CARDAS

Cardas para taladro

Tipo de carda



0.3mm diámetro de alambre de acero prensado
Ideal para oxidación ligera y remoción de pintura para metal



Nylon grueso (#80)
Ideal para oxidación ligera y remoción de pintura en metal, madera y PVC



Nylon fino (#240)
Ideal para acabado en superficie de metal y PVC

Forma



Tipo copa
Efectivo para superficies planas o rugosas

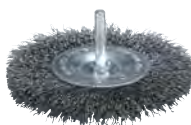

Tipo disco
Efectivo para trabajo en un punto



Tipo final
Efectivo para lugares estrechos o apretados



Tipo flap
Efectivo para tratamiento de madera

Gráfica de material

AA : Recomendado

A : Aceptable

Carda tipo			
	0.3mm diámetro de alambre de acero prensado	Nylon grueso (#80)	Nylon fino (#240)
Madera		AA	AA
PVC		AA	AA
Metal	AA	AA	AA
Acabado (Superficie de metal)			 Carda de nylon fino (#240) después carda para cubierta Nylon (#80)

Escobilla de nylon para taladro

Carda de nylon tipo copa



Tamaño	Grano	Zanco	No. Parte
50mm(2")	#80	6mm (1/4")	D-45509
63mm(2-1/2")	#80	6mm (1/4")	D-45515
75mm(3")	#80	6mm (1/4")	D-45521
50mm(2")	#240	6mm (1/4")	D-45537
63mm(2-1/2")	#240	6mm (1/4")	D-45543
75mm(3")	#240	6mm (1/4")	D-45559

Cepillo de nylon tipo flap



Tamaño	Grano	Zanco	Aplicación	No. Parte
100mm(4")	#80	6mm (1/4")		D-45749
100mm(4")	#240	6mm (1/4")		D-45755

Set de cardas de nylon para taladro

NUEVO

Disco de nylon para cepillado



Tamaño	Grano	Zanco	No. Parte
38mm (1-1/2")	#80	6mm (1/4")	D-45565
50mm (2")	#80	6mm (1/4")	D-45571
63mm (2-1/2")	#80	6mm (1/4")	D-45587
75mm (3")	#80	6mm (1/4")	D-45593
100mm (4")	#80	6mm (1/4")	D-45602
38mm (1-1/2")	#240	6mm (1/4")	D-45618
50mm (2")	#240	6mm (1/4")	D-45624
63mm (2-1/2")	#240	6mm (1/4")	D-45630
75mm (3")	#240	6mm (1/4")	D-45646
100mm (4")	#240	6mm (1/4")	D-45652



Carda de nylon tipo copa

Efectiva para superficies planas o rugosas.

Carda de nylon circular

Adecuada para eliminar óxido.

Escobilla de nylon para acabado

Tamaño	Grano	Zanco	No. Parte
12mm (1/2")	#80	6mm (1/4")	D-45668
19mm (3/4")	#80	6mm (1/4")	D-45674
25mm (1")	#80	6mm (1/4")	D-45680
30mm (1-1/4")	#80	6mm (1/4")	D-45696
12mm (1/2")	#240	6mm (1/4")	D-45705
19mm (3/4")	#240	6mm (1/4")	D-45711
25mm (1")	#240	6mm (1/4")	D-45727
30mm (1-1/4")	#240	6mm (1/4")	D-45733



Carda de nylon tipo brocha

Ideal para trabajos ligeros, trabajos en áreas de difícil acceso (tubos y perfiles)

Descripción	Grano	Tamaño zanco	Empaque piezas	No. Parte
Carda tipo copa 50mm Carda circular 50mm Carda tipo brocha 24mm	80, grueso	Zanco de 6mm (1/4") para taladro	3	D-70742
Carda tipo copa 50mm Carda circular 50mm Carda tipo brocha 24mm	240, fino	Zanco de 6mm (1/4") para taladro	3	D-70758

Carda copa de alambre para taladro

Tipo de cepillo: Anudado

NUEVO



Tamaño	Zanco	No. Parte
63mm (2-1/2")	6mm (1/4")	D-73798
75mm (3")	6mm (1/4")	D-73807

Carda copa de alambre para taladro

Tipo de cepillo: Rizado



Tamaño	Zanco	No. Parte
38mm (1-1/2")	6mm (1/4")	D-39908
50mm (2")	6mm (1/4")	D-39914
63mm (2-1/2")	6mm (1/4")	D-39920
75mm (3")	6mm (1/4")	D-39936
80mm (3-1/8")	6mm (1/4")	D-39942

Carda circular de alambre para taladro

Tipo de cepillo: Anudado

NUEVO



Tamaño	Zanco	No. Parte
75mm (3")	6mm (1/4")	D-73813
100mm (4")	6mm (1/4")	D-73829

Carda circular de alambre para taladro

Tipo de cepillo: Rizado



Tamaño	Zanco	No. Parte
38mm (1-1/2")	6mm (1/4")	D-39958
50mm (2")	6mm (1/4")	D-39964
63mm (2-1/2")	6mm (1/4")	D-39970
75mm (3")	6mm (1/4")	D-39986
100mm (4")	6mm (1/4")	D-39992

Carda tipo brocha de alambre para taladro

Tipo de cepillo: Anudado

NUEVO



Tamaño	Zanco	No. Parte
12mm (1/2")	6mm (1/4")	D-73835
19mm (3/4")	6mm (1/4")	D-73841
24mm (1")	6mm (1/4")	D-73857
28mm (1-1/8")	6mm (1/4")	D-73863

Carda tipo brocha para taladro

Tipo de cepillo: Rizado



Tamaño	Zanco	No. Parte
12mm (1/2")	6mm (1/4")	D-40004
19mm (3/4")	6mm (1/4")	D-40010
25mm (1")	6mm (1/4")	D-40026
30mm (1-1/4")	6mm (1/4")	D-40032

Carda copa de alambre latonado para taladro

Tipo de cepillo: Rizado



NUEVO

Tamaño	Zanco	No. Parte
38mm (1-1/2")	6mm (1/4")	D-73601
50mm (2")	6mm (1/4")	D-73617
63mm (2-1/2")	6mm (1/4")	D-73623
75mm (3")	6mm (1/4")	D-73639
80mm (3-1/8")	6mm (1/4")	D-73645

Carda circular de alambre para taladro



NUEVO

Tamaño	Zanco	Aplicación	No. Parte
80x35mm	8mm	Acabados muaré o limpieza de superficies de madera	D-67608

Carda circular de alambre latonado para taladro

Tipo de cepillo: Rizado



NUEVO

Tamaño	Zanco	No. Parte
38mm (1-1/2")	6mm (1/4")	D-73651
50mm (2")	6mm (1/4")	D-73667
63mm (2-1/2")	6mm (1/4")	D-73673
75mm (3")	6mm (1/4")	D-73689
100mm (3-1/8")	6mm (1/4")	D-73695

Set de cardas para taladro



Carda tipo brocha de alambre latonado para taladro

Tipo de cepillo: Rizado



NUEVO

Tamaño	Zanco	No. Parte
12mm (1/2")	6mm (1/4")	D-73704
19mm (3/4")	6mm (1/4")	D-73710
24mm (1")	6mm (1/4")	D-73726
28mm (1-7/64")	6mm (1/4")	D-73732

Carda de alambre tipo copa

Ideal para trabajos ligeros, eliminación de recubrimientos, óxido y limpieza de superficies.
Para bordes, superficies planas e irregulares.

Carda de alambre circular

Ideal para trabajos ligeros, eliminación de recubrimientos, óxido y limpieza de superficies.
Para espacios estrechos o de difícil acceso.

Carda de alambre tipo brocha

Ideal para trabajos ligeros, trabajos en áreas de difícil acceso (tubos y perfiles)

Descripción	Tamaño zanco	Empaque piezas	No. Parte
Carda tipo copa 63mm (2-1/2") D-39920 Carda tipo copa 75mm (3") D-39936 Carda circular 75mm (3") D-39986 Carda circular 100mm (4") D-39992	Zanco de 6mm (1/4") para taladro	4	D-65729
Carda tipo copa 50mm (2") D-39914 Carda tipo copa 50mm (2") D-39964 Carda circular 25mm (1") D-40026	Zanco de 6mm (1/4") para taladro	3	D-66070

Cardas para esmeril

Para modelos:

A: 100mm disco / esmeriladora

B: 125, 150mm esmeriladora

C: 180, 230mm esmeriladora

D: 230mm esmeriladora

Carda copa de alambre ondulado

Empaque plástico



Para modelo	Tamaño	Cuerda	No. Parte
B	2-1/2"	M14	D-55099
B	3"	M14	D-55108
C	4"	M14	D-55114

Carda copa de alambre ondulado latonado

Empaque plástico



Para modelo	Tamaño	Cuerda	No. Parte
B	2-1/2"	M14	D-55348*
B	3"	M14	D-55354
C	3-1/2"	M14	D-55360*
C	4"	M14	D-55376*

Carda copa de alambre trenzado

Empaque plástico

*Cónica



Para modelo	Tamaño	Cuerda	No. Parte
B	2-1/2"	M14	D-55164*
B	3"	M14	D-55170
B	2-1/2"	M14	D-55217
C	4"	M14	D-55223

Carda circular de alambre trenzado



Para modelo	Tamaño	Cuerda	No. Parte
C	6"	M14	D-45761
C	7"	M14	D-45777
C	4"	M14	D-55245
C	4-1/2"	M14	D-55251
C	5"	M14	D-55267
C	6"	M14	D-55273
C	7"	M14	D-55289

Carda circular cóncava alambre ondulado

Empaque plástico



Para modelo	Tamaño	Cuerda	No. Parte
C	4"	M14	D-55382
C	4-1/2"	M14	D-55398

Carda circular cónica alambre trenzado



Para modelo	Tamaño	Cuerda	No. Parte
C	4"	M14	D-55407
C	4-1/2"	M14	D-55413

Carda copa de alambre ondulado

Empaque de plástico

Carda de alambre ondulado tipo copa



Para modelo	Tamaño	Cuerda	No. Parte
B	2-1/2"	5/8"	D-55120
C	3"	5/8"	D-55136
C	4"	5/8"	D-55310

Carda copa de alambre ondulado latonado

Empaque de plástico



Para modelo	Tamaño	Cuerda	No. Parte
B	2-1/2"	5/8"	D-55429
B	3"	5/8"	D-55435
C	3-1/2"	5/8"	D-55441
C	4"	5/8"	D-55457

Carda circular de alambre trenzado

Empaque de plástico



Para modelo	Tamaño	Cuerda	No. Parte
C	6"	5/8"	D-55295
C	7"	5/8"	D-55304

Carda copa de alambre trenzado

Empaque de plástico

Para modelo	Tamaño	Cuerda	No. Parte
B	2-1/2"	5/8"	D-55186
B	3"	5/8"	D-55192
C	2-1/2"	5/8"	D-55239
C	4"	5/8"	D-55326
B	4"	5/8"	D-55332



Carda copa de alambre ondulado



Ideal para remover oxido en superficies planas y bordes

Para modelo	Tamaño	Cuerda	No. Parte
A	2-1/2"	5/8"-11	D-26515
A	3"	5/8"-11	D-26521
C	4"	5/8"-11	D-31697

Carda circular cóncava alambre ondulado

Empaque de plástico

Para modelo	Tamaño	Cuerda	No. Parte
C	4"	5/8"	D-55463
C	4-1/2"	5/8"	D-55479



Carda copa de alambre trenzado

0.5mm alambre de acero trenzado 2
(Ideal para trabajo pesado, alambre de acero trenzado anudado doble, más fuerte)



Carda circular cóncava alambre trenzado

Empaque de plástico

Calibre 0.020"

Para modelo	Tamaño	Cuerda	No. Parte
C	4"	5/8"	D-55485
B	4-1/2"	5/8"	D-55491

Para modelo	Tamaño	Cuerda	No. Parte
A	2-1/2"	5/8"-11	D-26537
A	3"	5/8"-11	D-26543
A	2-1/2"	5/8"-11	D-26559
C	4"	5/8"-11	D-31706
C	4"	5/8"-11	D-31712

Carda copa de alambre ondulado latonado

(Ideal para remover óxido en superficies planas y bordes)



Para modelo	Tamaño	Cuerda	No. Parte
B	2-1/2"	5/8"- 11	D-39752
B	3"	5/8"- 11	D-39774
C	3-1/2"	5/8"- 11	D-39796
C	4"	5/8"- 11	D-39811

Carda de copa de alambre trenzado multirosca

(Para esmeriladoras angulares de todas las marcas 4-1/2", 7", 9")



Tipo	Diámetro	Eje	No. Parte
Copa	3"	Multirosca (M14-5/8")	P-04488
Copa	3-1/2"	Multirosca (M14-5/8")	P-04472

Carda circular cóncava de alambre ondulado

Mejor para limpiar por todos lados



Para modelo	Tamaño	Cuerda	No. Parte
B, C	4"	5/8"-11	D-39833
B, C	4-1/2"	5/8"-11	D-39855

Carda circular multirosca Trenzada



Tipo	Diámetro	Eje	No. Parte
Circular	4"	Multirosca (M14-5/8")	P-04494

Carda circular cóncava de alambre trenzado

0.5mm alambre de acero trenzado
Efectivo para orillas y esquinas



Para modelo	Tamaño	Cuerda	No. Parte
B, C	4"	5/8"-11	D-39877
B, C	4-1/2"	5/8"-11	D-39899

Cepillo- Tipo rodillo

Para modelo 9741

NUEVO

Ideal para remover óxido y grano de madera, pulido de superficies planas, eliminación de óxido, cepillado de base antes de enchapar, descamación de pintura, etc.



Carda circular cónica de alambre ondulado

0.5mm alambre de acero



(Para esmeriladoras angulares de todas las marcas 4-1/2", 7", 9")

Tipo	Diámetro	Eje	No. Parte
Copa	2-1/2"	Multirosca (M14 - 5/8")	T-01993
Copa	4"	Multirosca (M14 - 5/8")	T-02004
Copa	5"	Multirosca (M14 - 5/8")	T-02010

Carda circular cóncava de alambre ondulado multirosca



Tipo	Diámetro	Eje	No. Parte
Cóncava	3-1/2"	Multirosca (M14 - 5/8")	T-02026

Tipo	Dimensiones	Aplicación	No. Parte
Rueda de alambre de acero	100x120cm	Eliminación de óxido	D-73564
Rueda de alambre de acero latonado	100x120cm	Lijar metal y trabajo de grano de madera	D-73570
Rueda de nylon Grano #60	100x120cm	Eliminación de vetas de madera y óxido	D-73586
Rueda de nylon Grano #80	100x120cm	Eliminación de vetas de madera y óxido	D-73592
Rodillo de lija Grano #40 (USA)		Para lijar y eliminar óxido y pintura	794380-1



DISCOS ABRASIVOS



Larga vida



Flexible



**Siempre use almohadilla
de respaldo**

CONOCIMIENTOS BÁSICOS

LECTURA DE LA ETIQUETA

1 Tipo de grano

2 Tamaño de grano

3 Dureza del disco

4 Pictogramas de uso seguro

Aplicaciones:

- Azul:** Metal
- Dorado:** INOX
- Verde:** Mampostería
- Plata:** Aluminio

Especificaciones:

- Tipo de grano
- Tamaño de grano
- Dureza del disco

1 Tipo de grano

WA36N-BF

- A** Aluminio café fundido
Para uso general
- WA** Óxido de aluminio blanco
Para INOX
- Z** Aluminio de Zirconia
Para uso pesado
- C** Carburo de silicio
Para concreto y metales no ferrosos
- GC** Carburo de silicio
Para vidrio y piedra



2 Tamaño del grano



3 Grado

Grado= Dureza del disco

WA36N-BF	Muy suave	Suave	Medio	Duro	Muy duro
	A ··· · G	H ··· · K	L M N O	P Q R S	T U V ··· · Z

- Trabajos pesados ➡ Discos suaves
- Discos duros ➡ Trabajos ligeros

WA36N-BF Aglutinante Resina de Fenol

4 Pictograma



No usar si esta dañado



No usar la orilla para desbastar



Consulte el manual de uso



No usar en herramientas o maquinas manuales



Usar solo con respaldo



Usar lentes de seguridad



Usar protección auditiva



Usar guantes



Usar cubrebocas

DESBASTE

Centro Deprimido ó hundido

Para metal

Calidad estandar, uso general

Calidad estable y buena
Adecuado para cualquier metal



NUEVO
D-18194-20

Eje	Diámetro	Espesor	Empaque Piezas	No. parte
5/8"	4"	4.7mm	1	741402-B
5/8"	4"	6mm	1	D-18188
7/8"	4"	6mm	1	D-56471
7/8"	4-1/2"	6mm	1	B-44264
7/8"	4-1/2"	6mm	1	D-18194
7/8"	4-1/2"	6mm	20	D-18194-20
7/8"	5"	2.5mm	1	D-18203
7/8"	7"	6mm	1	B-44286
7/8"	7"	6mm	1	D-18219
7/8"	9"	6mm	1	B-44301
7/8"	9"	6mm	1	D-18225



B-44270

Con adaptador

Eje	Diámetro	Espesor	Empaque Piezas	No. parte
5/8"	4-1/2"	6mm	1	B-44270
5/8"	7"	6mm	1	B-44292

Para acero Inox

Alta calidad, uso general



B-44236

Alto desempeño
suave y confortable al desbastar

Eje	Diámetro	Espesor	Empaque Piezas	No. parte
7/8"	4-1/2"	6mm	1	B-44111
7/8"	5"	6mm	1	B-44161
7/8"	7"	6mm	1	B-44199
7/8"	9"	6mm	1	B-44236

Para aluminio



B-44052

Especial para desbaste de aluminio
Alta remoción
Menos carga

Eje	Diámetro	Espesor	Empaque Piezas	No. parte
7/8"	4"	6mm	1	B-44052
7/8"	4-1/2"	6mm	1	B-44105
7/8"	5"	6mm	1	B-44155
7/8"	7"	6mm	1	B-44183

Para concreto

Calidad estandar, uso general



D-18231

Eje	Diámetro	Espesor	Empaque Piezas	No. parte
5/8"	4"	6mm	1	D-18231
7/8"	4-1/2"	6mm	1	D-18247
7/8"	5"	6mm	1	D-18253
7/8"	7"	6mm	1	D-18275
7/8"	9"	6mm	1	D-18281

DESBASTE PESADO Centro Deprimido ó hundido

Para acero Inox y metal

Alta calidad, para trabajo pesado con espesor de 7.0mm



B-68367

Adecuado para uso en la industria pesada
Alto poder de desbaste que proporciona una larga vida
Máxima eficiencia: Reduce las horas de trabajo

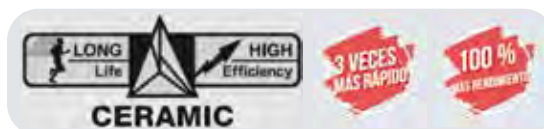

Larga Vida
Grano: Cerámica

Grano	Diámetro	Espesor	Empaque Piezas	No. parte
A24P	4-1/2"	7.0mm	1	B-68367

Ver video



DESBASTE PESADO Centro Deprimido ó hundido

Para acero Inox y acero normal

Alta calidad, para trabajo pesado con espesor de 7.2mm



B-62290

LONG LIFE

Larga Vida

Grano: Óxido de aluminio

Grano	Diámetro	Espesor	Empaque Piezas	No. parte
A24S	5"	7.2mm	1	B-62315
A24S	7"	7.2mm	1	B-65121

Para acero Inox y acero normal

Alta calidad, para trabajo pesado con espesor de 7.2mm



B-62309

Adecuado para uso en la industria pesada
Alto desempeño y larga vida

High Performance LONG LIFE

Grano: Zirconia

Grano	Diámetro	Espesor	Empaque Piezas	No. parte
AZ24S	4-1/2"	7.2mm	1	B-62309
AZ24S	5"	7.2mm	1	B-62321
AZ24S	7"	7.2mm	1	B-65137

Para acero Inox y acero normal

Alto rendimiento



B-21157

Adecuado para acero y hierro fundido

Eje	Diámetro	Espesor	Empaque Piezas	No. parte
5/8"	4"	6mm	1	B-21157
7/8"	4-1/2"	6mm	1	B-21163
7/8"	5"	6mm	1	B-21179
7/8"	7"	6mm	1	B-21185
7/8"	9"	6mm	1	B-21191

DISCOS FLEXIBLES

Disco de desbaste flexible

Para acero Inox

Alta remoción con sensación suave al trabajar

CARACTERISTICAS

- Baja vibración y ruido
- Reduce fátiga del operador
- Alto desempeño al desbastar



* El respaldo no es necesario para su uso
* Para herramienta inalámbrica



Eje	Diámetro	Espesor	Empaque Piezas	No. parte
7/8"	4-1/2"	4.0mm	1	B-49878 *

* Usar respaldo

Eje	Diámetro	Espesor	Grano	Empaque Piezas	No. parte
7/8"	4-1/2"	3.0mm	36	1	B-18502
7/8"	4-1/2"	3.0mm	60	1	B-18524
7/8"	4-1/2"	3.0mm	80	1	B-18530
7/8"	7"	3.0mm	36	1	B-18580
7/8"	7"	3.0mm	60	1	B-18605

Para acero, hierro fundido, soldadura

Alta remoción con sensación suave al trabajar

Adecuado para acero, hierro fundido y soldadura



* Usar respaldo

Eje	Diámetro	Espesor	Grano	Empaque Piezas	No. parte
7/8"	4-1/2"	3.0mm	36	1	B-18275
7/8"	4-1/2"	3.0mm	60	1	B-18297
7/8"	4-1/2"	3.0mm	80	1	B-18306
7/8"	7"	3.0mm	36	1	B-18356
7/8"	7"	3.0mm	60	1	A-88490

Respaldo de plástico

Complemento indispensable



Descripción	Diámetro	Empaque Piezas	No. parte
Respaldo de plástico (complemento indispensable)	4-1/2"	1	B-20482
Respaldo de plástico (complemento indispensable)	7"	1	B-20498

APLICACIÓN

Discos de desbaste y desbaste flexible

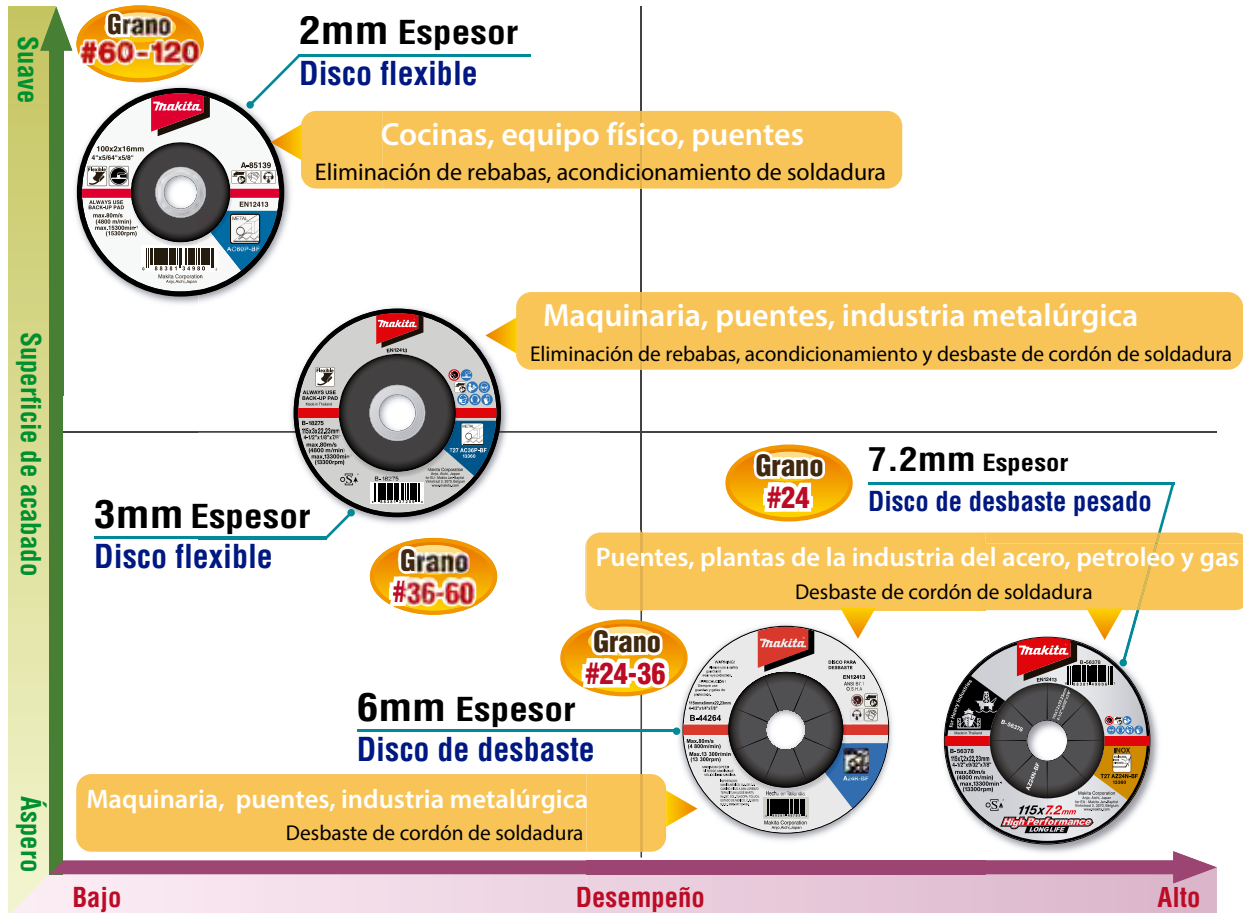

Aplicación principal

Eliminación de rebaba

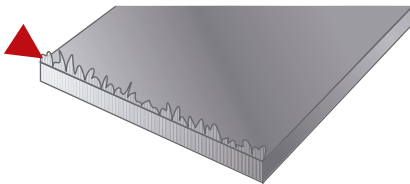

Desbaste cordón de soldadura

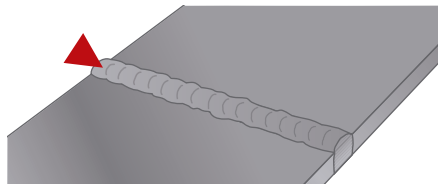

Desbaste de bordes

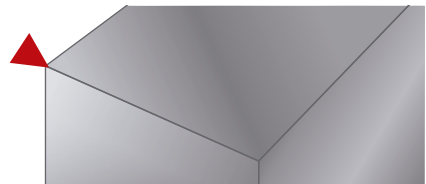

CORTE

Discos de corte y desbaste

Para metal

Calidad estandar, uso general



Tipo económico
Adecuado para cualquier metal

Eje	Diámetro	Espesor	Empaque Piezas	No. parte
5/8"	4"	3mm	1	B-44074
7/8"	4-1/2"	3mm	1	B-44127
7/8"	7"	3mm	1	B-44208
7/8"	9"	3mm	1	B-44242
7/8"	4-1/2"	3mm larga vida	1	D-45456

Para concreto / piedra

Calidad estandar, uso general



Adecuado para piedra, concreto y metales no ferrosos

Eje	Diámetro	Espesor	Empaque Piezas	No. parte
5/8"	4"	3mm	1	B-44080
7/8"	4-1/2"	3mm	1	B-44133
7/8"	7"	3mm	1	B-44214
7/8"	9"	3mm	1	B-44258

Para inox y acero común

Corte rápido y desbaste ligero



Fast cutting
Se puede usar para corte y desbaste
Centro hundido, tipo 27
* Especial para herramientas a batería

Corte

Desbaste



Eje	Diámetro	Espesor	Empaque Piezas	No. parte
7/8"	4-1/2"	2mm	1	B-52071

CORTE

Discos de corte, corte y desbaste

Para acero

Calidad estandar, para corte y desbaste



B-48686

2 en 1

Adecuado para el mantenimiento de tubería de excavación

Centro de hundido Tipo 27

Corte rápido y desbaste suave

Eje	Diámetro	Espesor	Empaque Piezas	No. parte
7/8"	4-1/2"	3.2mm	1	B-44096
7/8"	7"	4.0mm	1	B-48686

DISCOS DE CORTE PRECISO

Para inox y acero normal

Calidad estandar, para uso general



B-35433

Larga vida

Adecuado para cualquier acero

Corte estable

Tipo plano

Eje	Diámetro	Espesor	Empaque Piezas	No. parte
7/8"	4-1/2"	1.6mm	1	B-13817
7/8"	5"	1.6mm	1	B-35433



B-60486

Línea estandar

Adecuado para inox y acero común

Corte estable

NUEVO

Tipo plano

Eje	Diámetro	Espesor	Empaque Piezas	No. parte
5/8"	4"	1.6mm	1	B-49529
7/8"	4-1/2"	1.6mm	1	B-49535
7/8"	5"	1.6mm	1	B-49541
7/8"	7"	1.8mm	1	B-60470
7/8"	9"	2.0mm	1	B-60486

DISCOS DE CORTE PRECISO

Para inox y acero normal

Discos de alta calidad



B-48848



B-49513

Disco de corte más delgado
Corte más rápido
Corte suave
Menos rebaba, menos calentamiento



*Para herramienta inalámbrica
Tipo plano



Eje	Diámetro	Espesor	Empaque Piezas	No. parte
5/8"	4"	0.8mm	1	B-48848
7/8"	4-1/2"	0.8mm	1	B-48670
7/8"	5"	0.8mm	1	B-48854

Tipo 27, centro hundido

Eje	Diámetro	Espesor	Empaque Piezas	No. parte
7/8"	4-1/2"	0.8mm	1	B-49507
7/8"	5"	0.8mm	1	B-49513

DISCOS DE CORTE

Para aluminio

Discos de alta calidad



B-50332

Corte rápido
Larga vida
Adecuado para corte de aluminio



Tipo plano

Eje	Diámetro	Espesor	Empaque Piezas	No. parte
7/8"	4-1/2"	1.1mm	1	B-50310
7/8"	5-1/2"	1.1mm	1	B-50326
7/8"	6"	1.6mm	1	B-50332
7/8"	7"	1.6mm	1	B-50348
7/8"	9"	1.9mm	1	B-50354

DISCOS DE CORTE

Para inox

Discos de alta calidad



NUEVO
E-03006
**Para DCE090



B-12479-10

Larga vida- corte rápido
Adecuado para inox
Alta calidad
*Para herramienta inalámbrica
**Para DCE090



Eje	Diámetro	Espesor	Empaque Piezas	No. parte
5/8"	4"	1.0mm	1	B-12441
7/8"	4-1/2"	1.0mm	1	B-12457
7/8"	5"	1.0mm	1	B-12479
7/8"	5"	1.6mm	1	B-12251
7/8"	7"	1.6mm	1	B-12500
7/8"	9"	1.9mm	1	B-12516
7/8"	9"	1.9mm	1	**E-03006

Presentación en lata

Eje	Diámetro	Espesor	Empaque Piezas	No. parte
5/8"	4"	1.0mm	10	B-12441-10
7/8"	5"	1.0mm	10	B-12479-10

Para metal e inoxidable

Discos de corte de tipo delgado



B-65171

Para corte instantáneo al ras
Disco concavo
*Para herramienta inalámbrica



NUEVO

Eje	Diámetro	Espesor	Empaque Piezas	No. parte
7/8"	4-1/2"	1.2mm	1	B-65143
7/8"	5"	1.2mm	1	B-65159
7/8"	7"	1.6mm	1	B-65165
7/8"	9"	1.9mm	1	B-65171

NUEVO

DISCOS PARA CORTE DE ACERO INOXIDABLE

NUEVOS DISCOS PARA CORTE DE ACERO INOXIDABLE contienen Bajo contenido en hierro (Fe) Azufre (S) y Cloro (CL)

Evitando la oxidación después de realizar el corte

Proporcionan

- Cortes más limpios
- Menos rebaba
- Mayor rendimiento
- Mayor vida útil

Fe/S/Cl
<0,1%

ESPESOR

1.0
mm



NUEVO

PRÓXIMAMENTE

D-75574

DIÁMETRO de 7"

180mm x 22.23mm

ESPESOR

2.0
mm

DIÁMETRO de 4-1/2"
115mm x 22.23mm

El equipo estándar (accesorios), las especificaciones y las fotografías pueden variar.
Los accesorios pueden no estar incluidos desde origen con las herramientas, aunque se indiquen en este catálogo.



DISCOS DE CORTE

Para metal

Línea estandar



D-18297

Eje	Diámetro	Espesor	Empaque Piezas	No. parte
5/8"	4"	2.5mm	1	D-18297
7/8"	4-1/2"	2.5mm	1	D-18306
7/8"	5"	2.5mm	1	D-18312
7/8"	7"	2.5mm	1	D-18328
7/8"	9"	2.5mm	1	D-18334

Para acero inoxidable

Línea estandar



D-18409

Eje	Diámetro	Espesor	Empaque Piezas	No. parte
5/8"	4-1/2"	1.0mm	1	D-71685
5/8"	4"	1.0mm	1	D-18390
7/8"	4-1/2"	1.2mm	1	D-18409
7/8"	7"	2.0mm	1	D-18421
7/8"	9"	2.0mm	1	D-18437
5/8"	4"	1.2mm	1	D-65947
7/8"	4-1/2"	1.2mm	1	D-65953
7/8"	5"	1.2mm	1	D-65969

Para concreto

Línea estandar



D-18340

Eje	Diámetro	Espesor	Empaque Piezas	No. parte
5/8"	4"	3.0mm	1	D-18340
7/8"	4-1/2"	3.0mm	1	D-18356
7/8"	5"	3.0mm	1	D-18362
7/8"	7"	3.0mm	1	D-18378
7/8"	9"	3.0mm	1	D-18384

E-10827-25

DISCO ABRASIVO PARA CORTE DE METAL

Diseñado para **TODAS** las necesidades del mercado **Mexicano**

NUEVO!

CLASSIC CUT

DIÁMETRO de 14"

355x3.0mm

ESPESOR 1/8"



Corte Rápido



Larga vida



Proporciona mayor vida útil



Ideal para trabajos en industria metal-mecánica, herrerías, talleres de metal, construcciones, fontaneros, etc

Tipo de grano: **OXIDO DE ALUMINIO**

Tamaño de grano: **36 (Grueso)**

Grado: **T (Duro)**

Resina: **BF (Resina de Fenol)**

**Presentación
Caja de 25 pzs**

**Ideal para usar con Cortadoras de metal
(Modelos 2414NB, LW1401, M2401G)**

**Para corte de
METAL**



El equipo estándar (accesorios), las especificaciones y las fotografías pueden variar.
Los accesorios pueden no estar incluidos desde origen con las herramientas, aunque se indiquen en este catálogo.

DISCOS DE CORTE (PARA TRONZADORAS)

Para acero común e inox

Calidad estandar, para uso general

Larga vida



Eje	Diámetro	Espesor	Empaque Piezas	No. parte
1"	14"	3.0mm	25	A-89872-25
1"	14"	3.0mm	25	B-30514-25

A-89872-25



Corte rápido



Corte suave y rápido

NUEVO

Eje	Diámetro	Espesor	Empaque Piezas	No. parte
1"	14"	3.0mm	25	B-64755-25

Para INOX

NUEVO

Eje	Diámetro	Espesor	Empaque Piezas	No. parte
1"	14"	2.8mm	25	B-64749-25

Para Corte de aluminio



NUEVO

Eje	Diámetro	Espesor	Empaque Piezas	No. parte
1"	14"	2.8mm	25	E-04977-25

Larga vida / corte rápido / doble malla
* Especial para cortadora inalámbrica

Eje	Diámetro	Espesor	Empaque Piezas	No. parte
1"	14"	2.5mm	25	B-57118-25
1"	14"	2.5mm	25	B-64727-25*
1"	14"	2.5mm	5	B-64727-5*

Extra larga vida / doble malla / uso pesado



Eje	Diámetro	Espesor	Empaque Piezas	No. parte
1"	14"	3.0mm	1	B-14598-25
1"	16"	3.0mm	1	A-87694-25

B-57118-25



APLICACIÓN Discos de corte

Materiales gruesos y grandes

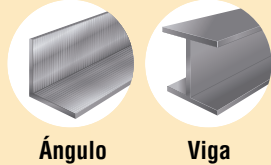
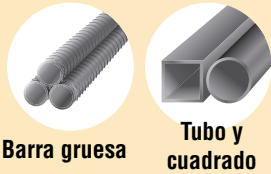

Tamaño regular

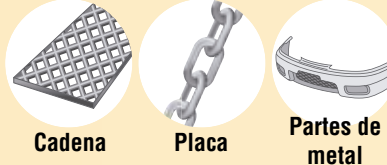

Materiales delgados y pequeños

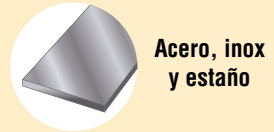

Disco de 14"
Corte delgado 9"x1.9mm

Corte delgado 1.0mm
Corte delgado 1.6mm
Corte normal 2-3mm

Corte delgado 0.8mm
Corte delgado 1.0mm



Tabla de rendimiento

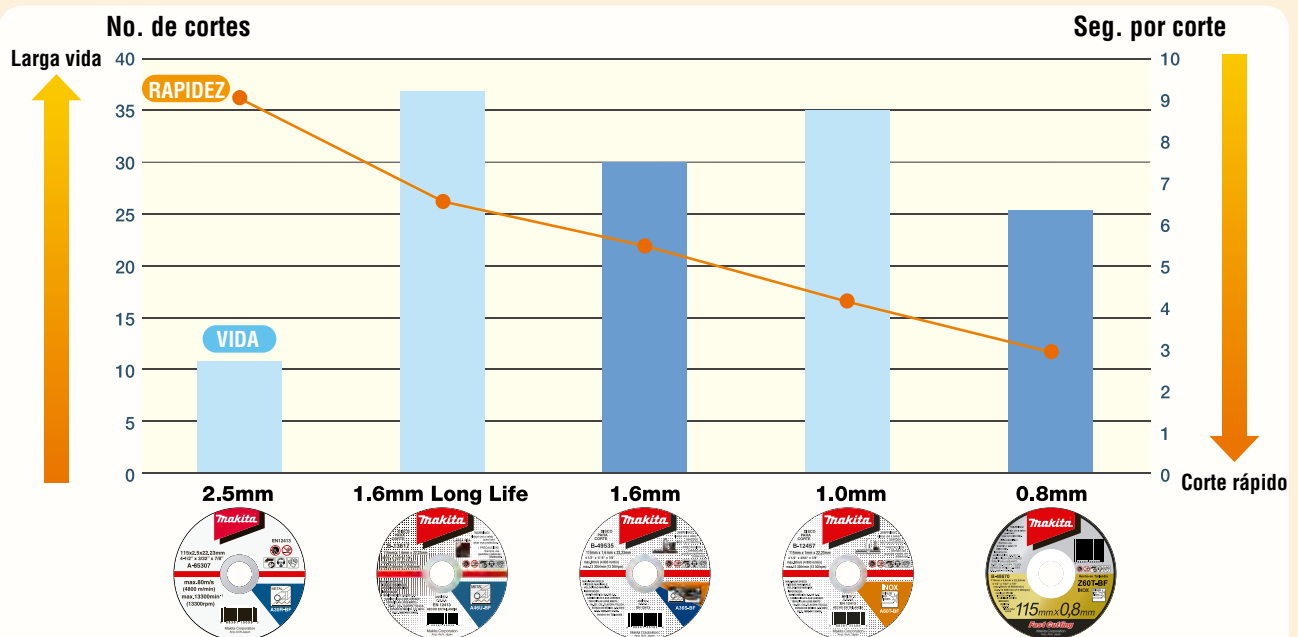

El equipo estándar (accesorios), las especificaciones y las fotografías pueden variar. Los accesorios pueden no estar incluidos desde origen con las herramientas, aunque se indiquen en este catálogo.

Ruedas abrasivas

Para esmeril de banco

NUEVO



Material	Diámetro	Espesor	Eje	Grano	Empaque Piezas	No. Parte
metal	150mm (6")	16mm(5/8")	12.7mm(1/2")	A36M	1	B-51904
metal	150mm (6")	16mm(5/8")	12.7mm(1/2")	A60M	1	B-51910
no ferrosos	150mm (6")	16mm(5/8")	12.7mm(1/2")	GC120H	1	B-51932
metal	205mm (8")	19mm(3/4")	15.88mm	A36P	1	B-51948
metal	205mm (8")	19mm(3/4")	15.88mm	A60P	1	B-51954
no ferrosos	205mm	19mm(3/4")	15.88mm	GC120H	1	B-51976

Piedra para afilar

Para GE0600 y 9803

Usar en	Parte No.
3501N	794063-3
9803	A-24642



Puntas montadas para rectificador

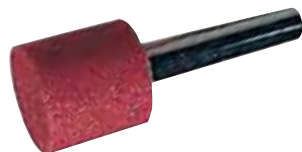

Usar en	Forma	Espesor	Zanco	Empaque Piezas	No. Parte
906, GD0800C, GD0810C, GD0600, BGD800, BGD801	Cilíndrica	19mm (3/4")	1/4"	1"	741617-7
906, GD0800C, GD0810C, GD0600, BGD800, BGD801	Cónica	19mm (3/4")	1/4"	1"	741616-9

Limas rotativas para metal

Línea estándar

10 veces más velocidad de corte y hasta 200 veces más durabilidad que las limas montadas



Lima standard

Remueve y desbasta con gran eficiencia

Material	Zanco	Tipo	Forma	Empaque piezas	No. Parte
Metal	1/4"	Estándar	Cilíndrica	1	B-52962
Metal	1/4"	Estándar	Redonda	1	B-52990
Metal	1/4"	Estándar	Árbol	1	B-53023
Metal	1/4"	Estándar	Cónica	1	B-53051
Metal	1/4"	Estándar	Cónica	1	B-53089

Limas rotativas para Inox

Línea estándar



Lima Diamante

Reduce la vibración y un manejo suave evitando fatiga al operador

Material	Zanco	Tipo	Forma	Empaque piezas	No. Parte
Inox	1/4"	Diamante	Cilíndrica	1	B-52978
Inox	1/4"	Diamante	Redonda	1	B-53001
Inox	1/4"	Diamante	Árbol	1	B-53039
Inox	1/4"	Diamante	Cónica	1	B-53067
Inox	1/4"	Diamante	Cónica	1	B-53095

Limas rotativas para aluminio

Línea NO Ferroso



Previene atascos en el uso evitando dañar el material

Material	Zanco	Tipo	Forma	Empaque piezas	No. Parte
Aluminio	1/4"	No ferrosos	Cilíndrica	1	B-52984
Aluminio	1/4"	No ferrosos	Redonda	1	B-53017
Aluminio	1/4"	No ferrosos	Árbol	1	B-53045
Aluminio	1/4"	No ferrosos	Cónica	1	B-53073
Aluminio	1/4"	No ferrosos	Cónica	1	B-53104



PRODUCTOS DE LIJA Y FIBRA



Respaldo de gancho y bucle



Lijado de madera



Lijado de plástico



Pulido



Tamaño de grano



Para lijar grandes superficies de madera



Para remover pintura



Madera dura y blanda



Lijado de madera



Lijado de pintura



Para remover pintura de metal o pulir



Cerámica



Lijado de madera



Lijado de pintura



Lijado de metal

PAPEL LIJA

Estructura

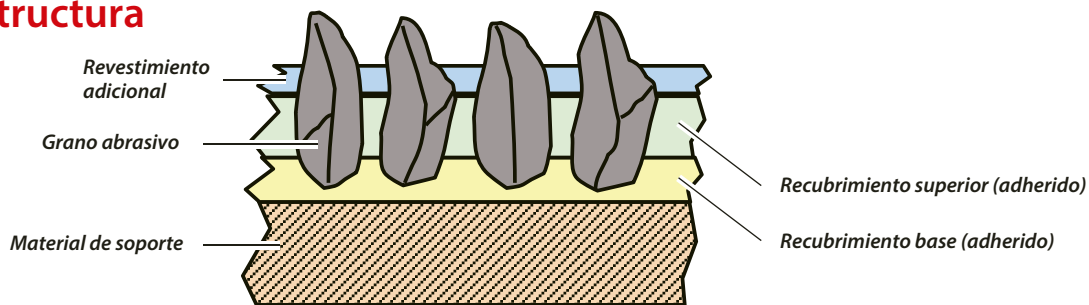

Grano abrasivo

Tipo de material	Óxido de aluminio	Carburo de silicio	Zirconia alumina
Imagen			
Código de grano	A&WA	C	Z
Aplicación	Madera, metal, etc.	Piedra, hierro fundido, vidrio, etc.	Aceros, tableros de fibra, INOX etc.

Explicación del tamaño de grano

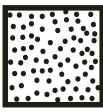
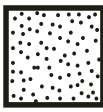
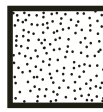
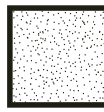
	Grueso	Medio	Fino	Muy fino
Tamaño de grano	- 80	80 - 120	120 - 400	400 -
Imagen				

Disco flap

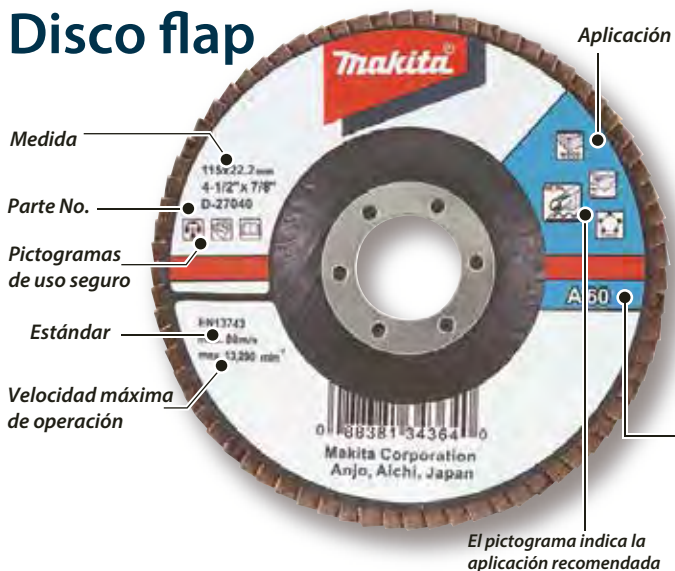

Gráfica de material

AA: Recomendado A: Aceptable

Descripción del material del grano	 Alúmina de óxido	 Alúmina de zirconio	 Carburo de silicio	 óxido de aluminio cerámico
Descripción de la etiqueta de color	El mejor para metal	El mejor para INOX y metal	El mejor para mampostería	El mejor para INOX, metal y metal no ferroso
Madera	A			
Plástico	A			
Metal	AA	AA		
No ferroso	A	A		AA
Inoxidable		AA		AA
Mampostería			AA	AA

Grano tipo / medida del grano

Tipo de apoyo

Forma tipo	Plano	Angular	Respaldo de Fibra de vidrio	Soporte Nylon
Plano				
	Efectivo para superficies planas	Efectivo para ángulos y esquinas	Soporte tipo estándar	Para uso pesado

Rollo de lija



Diámetro	Grano	Empaque piezas	No. Parte
120mm x 5m	60	1	P-38118
120mm x 5m	80	1	P-38124
120mm x 5m	120	1	P-38146

Hoja de lija completa de agua (23x28cm)

Para metal



Usar en	Grano	Empaque piezas	No. Parte
Metal	60	Paq. 10 pzs.	D-66151
Metal	80	Paq. 10 pzs.	D-66167
Metal	100	Paq. 10 pzs.	D-66173
Metal	120	Paq. 10 pzs.	D-66189
Metal	150	Paq. 10 pzs.	D-66195
Metal	180	Paq. 10 pzs.	D-66204
Metal	220	Paq. 10 pzs.	D-66210
Metal	280	Paq. 10 pzs.	D-66226
Metal	320	Paq. 10 pzs.	D-66232
Metal	400	Paq. 10 pzs.	D-66248
Metal	600	Paq. 10 pzs.	D-66254
Metal	800	Paq. 10 pzs.	D-66260
Metal	1000	Paq. 10 pzs.	D-66276
Metal	1200	Paq. 10 pzs.	D-66282
Metal	1500	Paq. 10 pzs.	D-66298
Metal	2000	Paq. 10 pzs.	D-66307
Metal	60	Paq. 50 pzs.	D-58936
Metal	80	Paq. 50 pzs.	D-58942
Metal	100	Paq. 50 pzs.	D-58958
Metal	120	Paq. 50 pzs.	D-58964
Metal	150	Paq. 50 pzs.	D-58970
Metal	180	Paq. 50 pzs.	D-58986
Metal	220	Paq. 50 pzs.	D-58992
Metal	280	Paq. 50 pzs.	D-59003
Metal	400	Paq. 50 pzs.	D-59025
Metal	600	Paq. 50 pzs.	D-59031
Metal	800	Paq. 50 pzs.	D-59047
Metal	1000	Paq. 50 pzs.	D-59053
Metal	1200	Paq. 50 pzs.	D-56851
Metal	1500	Paq. 50 pzs.	D-59069
Metal	2000	Paq. 50 pzs.	D-59075

Hoja de lija completa (23x28cm)

Para metal



Usar en	Grano	Empaque piezas	No. Parte
Metal	36	Paq. 10 pzs.	D-66488
Metal	40	Paq. 10 pzs.	D-66494
Metal	60	Paq. 10 pzs.	D-66503
Metal	80	Paq. 10 pzs.	D-66519
Metal	100	Paq. 10 pzs.	D-66525
Metal	120	Paq. 10 pzs.	D-66531
Metal	150	Paq. 10 pzs.	D-66547
Metal	180	Paq. 10 pzs.	D-66553
Metal	240	Paq. 10 pzs.	D-66569
Metal	36	Paq. 50 pzs.	D-56677
Metal	40	Paq. 50 pzs.	D-56683
Metal	60	Paq. 50 pzs.	D-56699
Metal	80	Paq. 50 pzs.	D-56708
Metal	100	Paq. 50 pzs.	D-56714
Metal	120	Paq. 50 pzs.	D-56720
Metal	150	Paq. 50 pzs.	D-56736
Metal	180	Paq. 50 pzs.	D-56742
Metal	240	Paq. 50 pzs.	D-56758

Hoja de lija completa (23x28cm)

Para pintura



Usar en	Grano	Empaque piezas	No. Parte
Pintura	80	Paq. 10 pzs.	D-66086
Pintura	100	Paq. 10 pzs.	D-66092
Pintura	120	Paq. 10 pzs.	D-66101
Pintura	150	Paq. 10 pzs.	D-66117
Pintura	180	Paq. 10 pzs.	D-66123
Pintura	220	Paq. 10 pzs.	D-66139
Pintura	240	Paq. 10 pzs.	D-66145
Pintura	80	Paq. 100 pzs.	D-60698
Pintura	100	Paq. 100 pzs.	D-60707
Pintura	120	Paq. 100 pzs.	D-60713
Pintura	150	Paq. 100 pzs.	D-60729
Pintura	180	Paq. 100 pzs.	D-60735
Pintura	220	Paq. 100 pzs.	D-60741
Pintura	240	Paq. 100 pzs.	D-60757
Pintura	280	Paq. 100 pzs.	D-60763
Pintura	320	Paq. 100 pzs.	D-60779
Pintura	360	Paq. 100 pzs.	D-60785
Pintura	400	Paq. 100 pzs.	D-60791
Pintura	500	Paq. 100 pzs.	D-60800
Pintura	600	Paq. 100 pzs.	D-60816
Pintura	800	Paq. 100 pzs.	D-60822

Hoja de lija completa (23x28cm)

Para madera



Usar en	Grano	Empaque piezas	No. Parte
Madera	40	Paq. 10 pzs.	D-66313
Madera	60	Paq. 10 pzs.	D-66329
Madera	80	Paq. 10 pzs.	D-66335
Madera	100	Paq. 10 pzs.	D-66341
Madera	120	Paq. 10 pzs.	D-66357
Madera	150	Paq. 10 pzs.	D-66363
Madera	180	Paq. 10 pzs.	D-66379
Madera	240	Paq. 10 pzs.	D-66385
Madera	320	Paq. 10 pzs.	D-66391
Madera	400	Paq. 10 pzs.	D-66400

Lija 1/4" de hoja normal



Usar en	Grano	Empaque piezas	No. Parte
Madera	60	10 pzs.	P-32904
Madera	100	10 pzs.	P-32910
Madera	120	10 pzs.	P-32926
Madera	150	10 pzs.	P-32932

Hoja de lija completa (23x28cm)

Para mortero



Usar en	Grano	Empaque piezas	No. Parte
Mortero	60	Paq. 10 pzs.	D-66416
Mortero	80	Paq. 10 pzs.	D-66422
Mortero	100	Paq. 10 pzs.	D-66438
Mortero	120	Paq. 10 pzs.	D-66444
Mortero	150	Paq. 10 pzs.	D-66450
Mortero	180	Paq. 10 pzs.	D-66466
Mortero	240	Paq. 10 pzs.	D-66472

Lija 1/4" de hoja con velcro perforada



Usar en	Grano	Empaque piezas	No. Parte
Madera	40	paq. 10 pzs.	P-33087
Madera	60	paq. 10 pzs.	P-33093
Madera	80	paq. 10 pzs.	P-33102
Madera	100	paq. 10 pzs.	P-33118
Madera	120	paq. 10 pzs.	P-33124
Madera	150	paq. 10 pzs.	P-33130
Madera	180	paq. 10 pzs.	P-33146
Madera	240	paq. 10 pzs.	P-33152
Madera	320	paq. 10 pzs.	P-33168

Lija 1/4" de hoja para madera



Usar en	Grano	Empaque piezas	No. Parte
Madera	100	10 pzs.	007431-0
Madera	150	10 pzs.	007432-0

Lija 1/3" de hoja Grano: Oxido de aluminio



Cubierta de estearato para mayor durabilidad



Usar en	Grano	Empaque piezas	No. Parte
Madera, pintura, metal, PVC	80	paq. 10 pzs.	D-65252
Madera, pintura, metal, PVC	100	paq. 10 pzs.	D-65268
Madera, pintura, metal, PVC	120	paq. 10 pzs.	D-65274
Madera, pintura, metal, PVC	180	paq. 10 pzs.	D-65280
Madera, pintura, metal, PVC	240	paq. 10 pzs.	D-65296
Madera, pintura, metal, PVC	320	paq. 10 pzs.	D-65305

Lija 1/4" de hoja con velcro perforada



Usar en	Grano	Empaque piezas	No. Parte
Madera pintura	40	paq. 10 pzs.	P-35807
Madera pintura	60	paq. 10 pzs.	P-35813
Madera pintura	80	paq. 10 pzs.	P-35829
Madera pintura	100	paq. 10 pzs.	P-35835
Madera pintura	120	paq. 10 pzs.	P-35841
Madera pintura	150	paq. 10 pzs.	P-35857
Madera pintura	180	paq. 10 pzs.	P-35863
Madera pintura	240	paq. 10 pzs.	P-35879
Madera pintura	320	paq. 10 pzs.	P-35885

Lija 1/3" de hoja normal

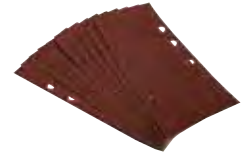

Usar en	Grano	Empaque piezas	No. Parte
Madera (con perforaciones)	40	Paq. 10 pzs.	P-31837
Madera (con perforaciones)	60	Paq. 10 pzs.	P-31843
Madera (con perforaciones)	80	Paq. 10 pzs.	P-31859
Madera (con perforaciones)	100	Paq. 10 pzs.	P-31865
Madera (con perforaciones)	120	Paq. 10 pzs.	P-36011
Madera (con perforaciones)	150	Paq. 10 pzs.	P-36027
Madera (con perforaciones)	180	Paq. 10 pzs.	P-36033
Madera (con perforaciones)	240	Paq. 10 pzs.	P-36049
Madera (con perforaciones)	60	Paq. 10 pzs.	P-32948

Lija 1/3" de hoja con velcro



Usar en	Grano	Empaque piezas	No. Parte
Madera (con perforaciones)	40	Paq. 10 pzs.	P-31871
Madera (con perforaciones)	60	Paq. 10 pzs.	P-31887
Madera (con perforaciones)	80	Paq. 10 pzs.	P-31893
Madera (con perforaciones)	100	Paq. 10 pzs.	P-31902

Lija de 1/2" hoja normal

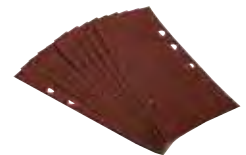

Usar en	Grano	Empaque piezas	No. Parte
Madera (con 6 perforaciones)	40	Paq. 10 pzs.	P-33009
Madera (con 6 perforaciones) normal	60	Paq. 10 pzs.	P-33015
Madera (con 6 perforaciones) normal	80	Paq. 10 pzs.	P-33021
Madera (con 6 perforaciones) normal	100	Paq. 10 pzs.	P-33037
Madera (con 6 perforaciones) normal	120	paq. 10 pzs.	P-33043
Madera (con 6 perforaciones) normal	150	paq. 10 pzs.	P-33059
Madera (con 6 perforaciones) normal	180	paq. 10 pzs.	P-33065
Madera (con 6 perforaciones) normal	240	paq. 10 pzs.	P-33071

Lija 1/4" de hoja Grano: Oxido de aluminio

Cubierta de estearato para mayor durabilidad



Usar en	Grano	Empaque piezas	No. Parte
Madera, pintura, metal, PVC	80	paq. 10 pzs.	D-65311
Madera, pintura, metal, PVC	100	paq. 10 pzs.	D-65327
Madera, pintura, metal, PVC	120	paq. 10 pzs.	D-65333
Madera, pintura, metal, PVC	180	paq. 10 pzs.	D-65349
Madera, pintura, metal, PVC	240	paq. 10 pzs.	D-65355
Madera, pintura, metal, PVC	320	paq. 10 pzs.	D-65361

Línea estándar

Lija perforada con velcro Para madera 5" Paquete con 10 piezas



Usar en	Grano	Empaque piezas	No. Parte
Madera	40	paq. 10 pzs.	D-54134
Madera	60	paq. 10 pzs.	D-54140
Madera	80	paq. 10 pzs.	D-54156
Madera	100	paq. 10 pzs.	D-54162
Madera	120	paq. 10 pzs.	D-54178
Madera	150	paq. 10 pzs.	D-54184
Madera	180	paq. 10 pzs.	D-54190
Madera	240	paq. 10 pzs.	D-54209

Lija perforada con velcro

Para madera 5"

Paquete con 5, 10 y 50 piezas



Disco de lijas

Usar en	Grano	Empaque piezas	No. Parte
Madera y metal	40	paq. 5 pzs.	742137-A
Madera y metal	60	paq. 5 pzs.	794518-8
Madera y metal	80	paq. 5 pzs.	794519-6
Madera y metal	100	paq. 5 pzs.	794523-A
Madera y metal	120	paq. 5 pzs.	794520-1
Madera y metal	180	paq. 5 pzs.	794521-9
Madera y metal	240	paq. 5 pzs.	794522-7
Madera y metal	320	paq. 5 pzs.	742526-A
Madera y metal	400	paq. 5 pzs.	742527-A
Madera y metal	120	paq. 5 pzs.	794544-7
Madera y metal	40	paq. 10 pzs.	P-43533
Madera y metal	60	paq. 10 pzs.	P-43549
Madera y metal	80	paq. 10 pzs.	P-43555
Madera y metal	100	paq. 10 pzs.	P-43561
Madera y metal	120	paq. 10 pzs.	P-43577
Madera y metal	180	paq. 10 pzs.	P-43583
Madera	240	paq. 10 pzs.	P-43599
Madera	320	paq. 10 pzs.	P-43608
Madera	400	paq. 10 pzs.	P-43614
Madera	40	paq. 50 pzs.	P-43620
Madera	60	paq. 50 pzs.	P-43636
Madera	80	paq. 50 pzs.	P-43642
Madera	100	paq. 50 pzs.	P-43658
Madera	120	paq. 50 pzs.	P-43664
Madera	180	paq. 50 pzs.	P-43670
Madera	240	paq. 50 pzs.	P-43686
Madera	320	paq. 50 pzs.	P-43692
Madera	400	paq. 50 pzs.	P-43701

Disco de lija de velcro 5"

Paquete con 50 piezas



Usar en	Grano	Empaque piezas	No. Parte
Madera y metal	40	Paq. 50 pzs.	742137-A50
Madera y metal	60	Paq. 50 pzs.	794518-8-50
Madera y metal	80	Paq. 50 pzs.	794519-6-50
Madera y metal	100	Paq. 50 pzs.	794523-A50
Madera y metal	120	Paq. 50 pzs.	794520-1-50
Madera y metal	180	Paq. 50 pzs.	794521-9-50
Madera y metal	240	Paq. 50 pzs.	794522-7-50
Madera y metal	320	Paq. 50 pzs.	742526-A50
Madera y metal	400	Paq. 50 pzs.	742527-A50

Disco de lija de velcro 5"

(Con 8 perforaciones)

NUEVO



Usar en	Grano	Empaque piezas	No. Parte
Pintura	40	paq. 10 pzs.	D-65816
Pintura	60	paq. 10 pzs.	D-65822
Pintura	80	paq. 10 pzs.	D-65838
Pintura	100	paq. 10 pzs.	D-65844
Pintura	120	paq. 10 pzs.	D-65850
Pintura	150	paq. 10 pzs.	D-65866
Pintura	180	paq. 10 pzs.	D-65872
Pintura	240	paq. 10 pzs.	D-65888
Pintura	320	paq. 10 pzs.	D-65894
Pintura	400	paq. 10 pzs.	D-65903

Línea estándar

Disco de lija de velcro 6"

NUEVO



Usar en	Grano	Empaque piezas	No. Parte
Madera	40	paq. 10 pzs.	D-54586
Madera	60	paq. 10 pzs.	D-54592
Madera	80	paq. 10 pzs.	D-54601
Madera	100	paq. 10 pzs.	D-54617
Madera	120	paq. 10 pzs.	D-54623

Línea estándar

Disco de lija de velcro 6"



Usar en	Grano	Empaque piezas	No. Parte
Madera	180	paq. 10 pzs.	D-54287
Madera	240	paq. 10 pzs.	D-54651

Disco de lija de velcro 6" (Con 8 perforaciones)



Usar en	Grano	Empaque piezas	No. Parte
Pintura	40	paq. 10 pzs.	P-37839
Pintura	60	paq. 10 pzs.	P-37845
Pintura	80	paq. 10 pzs.	P-37851
Pintura	100	paq. 10 pzs.	P-37867
Pintura	120	paq. 10 pzs.	P-37873
Pintura	150	paq. 10 pzs.	P-37889
Pintura	240	paq. 10 pzs.	P-37910

Disco de lija de velcro 6" (multipropósitos)



Usar en	Grano	Empaque piezas	No. Parte
Madera, pintura y metal	40	paq. 100 pzs.	B-39300
Madera, pintura y metal	60	paq. 100 pzs.	B-39316
Madera, pintura y metal	80	paq. 100 pzs.	B-39322
Madera, pintura y metal	120	paq. 100 pzs.	B-39344

Disco de lija de velcro 6" (con 6 perforaciones)



Usar en	Grano	Empaque piezas	No. Parte
Madera	40	paq. 50 pzs.	P-37568
Madera	60	paq. 50 pzs.	P-37574
Madera	80	paq. 50 pzs.	P-37580
Madera	100	paq. 50 pzs.	P-37596
Madera	120	paq. 50 pzs.	P-37605
Madera	180	paq. 50 pzs.	P-37611
Madera	240	paq. 50 pzs.	P-37627
Madera	320	paq. 50 pzs.	P-37633
Madera	400	paq. 50 pzs.	P-37649
Pintura	40	paq. 50 pzs.	P-37742
Pintura	60	paq. 50 pzs.	P-37758
Pintura	80	paq. 50 pzs.	P-37764
Pintura	100	paq. 50 pzs.	P-37770
Pintura	120	paq. 50 pzs.	P-37786

Disco de lija de velcro 6" (Con 8 perforaciones)



Usar en	Grano	Empaque piezas	No. Parte
Madera (con 6 perforaciones)	40	paq. 10 pzs.	P-37471
Madera (con 6 perforaciones)	60	paq. 10 pzs.	P-37487
Madera (con 6 perforaciones)	80	paq. 10 pzs.	P-37493
Madera (con 6 perforaciones)	120	paq. 10 pzs.	P-37502
Madera (con 6 perforaciones)	120	paq. 10 pzs.	P-37518
Madera (con 6 perforaciones)	180	paq. 10 pzs.	P-37524
Madera (con 6 perforaciones)	240	paq. 10 pzs.	P-37530
Madera (con 6 perforaciones)	320	paq. 10 pzs.	P-37546
Madera (con 6 perforaciones)	400	paq. 10 pzs.	P-37552
Madera (con 8 perforaciones)	40	paq. 10 pzs.	P-31918
Madera (con 8 perforaciones)	60	paq. 10 pzs.	P-31924
Madera (con 8 perforaciones)	80	paq. 10 pzs.	P-31930
Madera (con 8 perforaciones)	100	paq. 10 pzs.	P-31946
Madera (con 8 perforaciones)	120	paq. 10 pzs.	P-31952
Madera (con 8 perforaciones)	150	paq. 10 pzs.	P-31968
Madera (con 8 perforaciones)	180	paq. 10 pzs.	P-31974
Madera (con 8 perforaciones)	220	paq. 10 pzs.	P-31980
Madera (con 8 perforaciones)	240	paq. 10 pzs.	P-31996

Disco de lija de velcro 6" (con 6 perforaciones)



Usar en	Grano	Empaque piezas	No. Parte
Pintura	180	paq. 50 pzs.	P-37792
Pintura	240	paq. 50 pzs.	P-37801
Pintura	320	paq. 50 pzs.	P-37817
Pintura	400	paq. 50 pzs.	P-37823

Disco de lija de velcro 6" (Con 8 perforaciones)



Usar en	Grano	Empaque piezas	No. Parte
Madera (con 8 perforaciones)	320	paq. 10 pzs.	P-32007
Madera (con 8 perforaciones)	400	paq. 10 pzs.	P-32013
Madera	40	paq. 50 pzs.	P-32574
Madera	60	paq. 50 pzs.	P-32580
Madera	80	paq. 50 pzs.	P-32596
Madera	100	paq. 50 pzs.	P-32605
Madera	120	paq. 50 pzs.	P-32611
Madera	180	paq. 50 pzs.	P-32633
Madera	240	paq. 50 pzs.	P-32655
Madera	320	paq. 50 pzs.	P-32661
Madera	400	paq. 50 pzs.	P-32677

Disco de lija de velcro 6" (con 15 perforaciones) para madera



Usar en	Grano	Empaque piezas	No. Parte
Madera	40	paq. 10 pzs.	B-51415
Madera	60	paq. 10 pzs.	B-51421
Madera	80	paq. 10 pzs.	B-51437
Madera	100	paq. 10 pzs.	B-51443
Madera	120	paq. 10 pzs.	B-51459
Madera	180	paq. 10 pzs.	B-51465
Madera	240	paq. 10 pzs.	B-51471
Madera	320	paq. 10 pzs.	B-51487
Madera	400	paq. 10 pzs.	B-51493

Disco de lija de velcro 6" (con 15 perforaciones) para pintura



Usar en	Grano	Empaque piezas	No. Parte
Pintura	40	paq. 10 pzs.	B-51502
Pintura	60	paq. 10 pzs.	B-51518
Pintura	80	paq. 10 pzs.	B-51524
Pintura	100	paq. 10 pzs.	B-51530
Pintura	120	paq. 10 pzs.	B-51546
Pintura	180	paq. 10 pzs.	B-51552
Pintura	240	paq. 10 pzs.	B-51568
Pintura	320	paq. 10 pzs.	B-51574
Pintura	400	paq. 10 pzs.	B-51580

Disco de lija para piedra

Pulido de superficies de piedra con pulidora PK5001C ó PK5011C



Diámetro	Grano	Empaque piezas	No. Parte
5"	24	paq. 5 pzs.	B-14526
5"	50	paq. 5 pzs.	B-14532
5"	80	paq. 5 pzs.	B-14548
5"	120	paq. 5 pzs.	B-14554

Discos de lija para piedra y mármol 7"



Usar en	Grano	Empaque piezas	No. Parte
Lijadoras y esmeriladoras 7"	24	Paq. 5pz.	A-92798-5
Lijadoras y esmeriladoras 7"	36	Paq. 5pz.	A-92807-5
Lijadoras y esmeriladoras 7"	180	Paq. 5pz.	A-92835-5

Discos de lija para esmeril (7")



Diámetro	Grano	Empaque piezas	No. Parte
180mm (7")	24	paq. 25 pzs.	P-43804
180mm (7")	36	paq. 25 pzs.	P-43810
180mm (7")	40	paq. 25 pzs.	P-43826
180mm (7")	50	paq. 25 pzs.	P-43832
180mm (7")	60	paq. 25 pzs.	P-43848
180mm (7")	80	paq. 25 pzs.	P-43854
180mm (7")	100	paq. 25 pzs.	P-43860
180mm (7")	120	paq. 25 pzs.	P-43876
180mm (7")	150	paq. 25 pzs.	P-43882

Discos de lija para acero



Usar en	Grano	Empaque piezas	No. Parte
Esmeriladoras 7"	80	Paq. 5Pzs.	A-92710-5

Hoja de lija para lijadora inalámbrica para tablaroca DSL800

9 hoyos

NUEVO



Usar en	Grano	Diámetro	Empaque piezas	No. Parte
DSL800	40	225mm	25	B-68389
DSL800	80	225mm	25	B-68395
DSL800	120	225mm	25	B-68404
DSL800	180	225mm	25	B-68410
DSL800	320	225mm	25	B-68426
DSL800	150	225mm	25	E-02375
DSL800	220	225mm	25	E-02381

Discos de fibra

*Negro-Estándar
**Morada-Larga vida



Material	Eje	Grano	Diámetro	Empaque piezas	No. Parte
*Metal / inox	7/8"	Ligero	4-1/2"	1	B-36619
**Metal / inox	7/8"	Long Life	4-1/2"	1	B-36653
*Metal / inox	7/8"	Ligero	7"	1	B-36631
**Metal / inox	7/8"	Long Life	7"	1	B-36675

Multidiscos insertados

Uso general
Línea profesional

Lijado y esmerilado de metales, maderas, plásticos y acero sin pintura.



Material	Eje	Diámetro	Grano	Empaque piezas	No. Parte
Metal / inox	7/8"	4-1/2"	40	1	B-06345
Metal / inox	7/8"	4-1/2"	60	1	B-06351
Metal / inox	7/8"	4-1/2"	80	1	B-06367
Metal / inox	7/8"	4-1/2"	120	1	B-06373
Metal / inox	7/8"	7"	40	1	B-06395
Metal / inox	7/8"	7"	60	1	B-06404
Metal / inox	7/8"	7"	80	1	B-06410
Metal / inox	7/8"	7"	120	1	B-06426

Multidiscos abrasivos angulares de zirconia para acero inoxidable

Línea industrial



Para uso pesado en metales ferrosos y acero inoxidable

Material	Eje	Diámetro	Grano	Empaque piezas	No. Parte
Metal / inox	7/8"	4-1/2"	40	1	B-34160
Metal / inox	7/8"	4-1/2"	60	1	B-34176
Metal / inox	7/8"	4-1/2"	120	1	B-34198
Metal / inox	7/8"	7"	40	1	B-34241
Metal / inox	7/8"	7"	60	1	B-34257
Metal / inox	7/8"	7"	80	1	B-34263
Metal / inox	7/8"	7"	120	1	B-34279

Multidiscos abrasivos angulares de zirconia

Línea industrial

Para uso pesado en metales ferrosos y acero inoxidable



Material	Eje	Diámetro	Grano	Empaque piezas	No. Parte
Metal	7/8"	4-1/2"	40	1	B-55603
Metal	7/8"	4-1/2"	60	1	B-55619
Metal	7/8"	4-1/2"	80	1	B-55625
Metal	7/8"	4-1/2"	120	1	B-55631
Metal	7/8"	4-1/2"	40	1	B-55647
Metal	7/8"	4-1/2"	60	1	B-55653
Metal	7/8"	4-1/2"	80	1	B-55669
Metal	7/8"	4-1/2"	120	1	B-55675

Multidiscos abrasivos angulares de zirconia para acero inoxidable

Línea estandar



Material	Eje	Diámetro	Grano	Empaque piezas	No. Parte
Metal / inox	7/8"	4-1/2"	36	1	D-53861
Metal / inox	7/8"	4-1/2"	40	1	D-53877
Metal / inox	7/8"	4-1/2"	60	1	D-53883
Metal / inox	7/8"	4-1/2"	80	1	D-53899
Metal / inox	7/8"	4-1/2"	120	1	D-53908
Metal / inox	7/8"	5"	36	1	D-53914
Metal / inox	7/8"	5"	40	1	D-53920
Metal / inox	7/8"	5"	60	1	D-53936
Metal / inox	7/8"	5"	80	1	D-53942
Metal / inox	7/8"	5"	120	1	D-53958
Metal / inox	7/8"	7"	36	1	D-53964
Metal / inox	7/8"	7"	40	1	D-53970
Metal / inox	7/8"	7"	80	1	D-53992
Metal / inox	7/8"	7"	120	1	D-54003

Multidiscos abrasivos angulares de zirconia para acero inoxidable

Línea estandar



NUEVO

Material	Eje	Diámetro	Grano	Empaque piezas	No. Parte
Metal / inox	7/8"	4-1/2"	Z40	1	D-63747
Metal / inox	7/8"	4-1/2"	Z60	1	D-63753
Metal / inox	7/8"	4-1/2"	Z80	1	D-63769
Metal / inox	7/8"	4-1/2"	Z120	1	D-63775
Metal / inox	7/8"	5"	Z40	1	D-63781
Metal / inox	7/8"	5"	Z60	1	D-63797
Metal / inox	7/8"	5"	Z80	1	D-63806
Metal / inox	7/8"	5"	Z120	1	D-63812
Metal / inox	7/8"	7"	Z40	1	D-63828
Metal / inox	7/8"	7"	Z60	1	D-63834
Metal / inox	7/8"	7"	Z80	1	D-63840
Metal / inox	7/8"	7"	Z120	1	D-63856

Multidiscos Flap de zirconia para acero inoxidable

Línea estándar

NUEVO

Ideal para trabajos estándar de acero, acero inoxidable y metal

Nuevo diseño PLANO DISCO FLAP



Diseño DISCO ANGULAR



Granos abrasivos de Zirconia que brindan alta durabilidad y abrasión



Material	Eje	Diámetro	Grano	Empaque piezas	No. Parte
Acero inoxidable y acero	7/8"	4-1/2"	Z40	1	D-74186
Acero inoxidable y acero	7/8"	4-1/2"	Z60	1	D-74192
Acero inoxidable y acero	7/8"	4-1/2"	Z80	1	D-74201
Acero inoxidable y acero	7/8"	4-1/2"	Z120	1	D-74217
Acero inoxidable y acero	7/8"	5"	Z40	1	D-74223
Acero inoxidable y acero	7/8"	5"	Z60	1	D-74239
Acero inoxidable y acero	7/8"	5"	Z80	1	D-74245
Acero inoxidable y acero	7/8"	5"	Z120	1	D-74251
Acero inoxidable y acero	7/8"	7"	Z40	1	D-74267
Acero inoxidable y acero	7/8"	7"	Z60	1	D-74272
Acero inoxidable y acero	7/8"	7"	Z80	1	D-74289
Acero inoxidable y acero	7/8"	7"	Z120	1	D-74295

Multidiscos insertados uso general

Para uso pesado en metales ferrosos y acero inoxidable



LONG LIFE

Material	Eje	Diámetro	Grano	Empaque piezas	No. Parte
Metal / inox	7/8"	4-1/2"	60	1	B-34291
Metal / inox	7/8"	4-1/2"	80	1	B-34300
Metal / inox	7/8"	4-1/2"	120	1	B-34316
Metal / inox	7/8"	7"	40	1	B-34366
Metal / inox	7/8"	7"	80	1	B-34388
Metal / inox	7/8"	7"	120	1	B-34394

Multidiscos insertado

Para madera y metal



Material	Eje	Diámetro	Grano	Empaque piezas	No. Parte
Metal, plástico y madera	7/8"	4-1/2"	40	1	D-32007
Metal, plástico y madera	7/8"	4-1/2"	60	1	D-32013
Metal, plástico y madera	7/8"	4-1/2"	80	1	D-32029
Metal, plástico y madera	7/8"	4-1/2"	120	1	D-32035
Metal, plástico y madera	7/8"	7"	40	1	D-32041
Metal, plástico y madera	7/8"	7"	60	1	D-32057
Metal, plástico y madera	7/8"	7"	80	1	D-32063
Metal, plástico y madera	7/8"	7"	120	1	D-32079
Concreto	7/8"	4-1/2"	40	1	D-31946
Concreto	7/8"	4-1/2"	60	1	D-31952
Concreto	7/8"	4-1/2"	80	1	D-31968
Acero inoxidable, alto rendimiento	7/8"	4-1/2"	40	1	D-31974
Acero inoxidable, alto rendimiento	7/8"	4-1/2"	60	1	D-31980
Acero inoxidable, alto rendimiento	7/8"	4-1/2"	80	1	D-31996
Acero inoxidable	7/8"	4-1/2"	40	1	D-32085
Acero inoxidable	7/8"	4-1/2"	60	1	D-32091
Acero inoxidable	7/8"	4-1/2"	80	1	D-32100
Acero inoxidable	7/8"	4-1/2"	120	1	D-32493

Multidiscos insertado

Para metal y PVC

NUEVO



Material	Eje	Diámetro	Grano	Empaque piezas	No. Parte
Metal, PVC	7/8"	4-1/2"	40	1	D-63432
Metal, PVC	7/8"	4-1/2"	60	1	D-63448
Metal, PVC	7/8"	4-1/2"	80	1	D-63454
Metal, PVC	7/8"	4-1/2"	120	1	D-63460
Metal, PVC	7/8"	5"	40	1	D-63476
Metal, PVC	7/8"	5"	60	1	D-63482
Metal, PVC	7/8"	5"	80	1	D-63498
Metal, PVC	7/8"	5"	120	1	D-63507
Metal, PVC	7/8"	7"	40	1	D-63513
Metal, PVC	7/8"	7"	60	1	D-63529
Metal, PVC	7/8"	7"	80	1	D-63535
Metal, PVC	7/8"	7"	120	1	D-63541

Discos de fibra

Para inoxidable



Descripción	Diámetro	Tipo	Empaque piezas	No. Parte
Disco de fibra	4-1/2"	Grueso con ángulo	1	B-41713
Disco de fibra	4-1/2"	Medio con ángulo	1	B-41729
Disco de fibra	4-1/2"	Fino con ángulo	1	B-41735
Disco de fibra	4-1/2"	Ultra-fino con ángulo	1	B-41741
Disco de fibra	5"	Grueso con ángulo	1	B-41757
Disco de fibra	5"	Medio con ángulo	1	B-41763
Disco de fibra	5"	Fino con ángulo	1	B-41779
Disco de fibra	5"	Ultra-fino con ángulo	1	B-41785
Disco de fibra	7"	Grueso con ángulo	1	B-41791
Disco de fibra	7"	Medio con ángulo	1	B-41800
Disco de fibra	7"	Fino con ángulo	1	B-41816
Disco de fibra	7"	Ultra-fino con ángulo	1	B-41822
Disco de fibra	4-1/2"	Grueso flap	1	B-41872
Disco de fibra	4-1/2"	Medio flap	1	B-41888
Disco de fibra	4-1/2"	Fino flap	1	B-41894
Disco de fibra	4-1/2"	Ultra-fino flap	1	B-41903
Disco de fibra	5"	Grueso flap	1	B-41919
Disco de fibra	5"	Medio flap	1	B-41925
Disco de fibra	5"	Fino flap	1	B-41931
Disco de fibra	5"	Ultra-fino flap	1	B-41947
Disco de fibra	7"	Grueso flap	1	B-41953
Disco de fibra	7"	Medio flap	1	B-41969
Disco de fibra	7"	Fino flap	1	B-41975
Disco de fibra	7"	Ultra-fino flap	1	B-41981



El equipo estándar (accesorios), las especificaciones y las fotografías pueden variar. Los accesorios pueden no estar incluidos desde origen con las herramientas, aunque se indiquen en este catálogo.

Lijas para lijadora de banda

Lijas para madera 1/4"x21"



Usar en	Grano	Empaque piezas	No. Parte
Madera	80	Paquete con 5 Pzs.	P-43206
Madera	100	Paquete con 5 Pzs.	P-43212
Madera	120	Paquete con 5 Pzs.	P-43228
Madera	150	Paquete con 5 Pzs.	P-43234
Madera	240	Paquete con 5 Pzs.	P-43240
Madera	80	Paquete con 10 Pzs.	A-34534
Madera	100	Paquete con 10 Pzs.	A-34540
Madera	120	Paquete con 10 Pzs.	A-34556

Lijas de banda para madera 1/2"x21"



Usar en	Grano	Empaque piezas	No. Parte
Madera	40	Paquete con 5 Pzs.	P-43321
Madera	60	Paquete con 5 Pzs.	P-43337
Madera	80	Paquete con 5 Pzs.	P-43343
Madera	100	Paquete con 5 Pzs.	P-43359
Madera	120	Paquete con 5 Pzs.	P-43365
Madera	150	Paquete con 5 Pzs.	P-43371
Madera	240	Paquete con 5 Pzs.	P-43387
Madera	40	Paquete con 10 Pzs.	A-34562
Madera	60	Paquete con 10 Pzs.	A-34578



Lijadora de banda 9031

Lijas de banda para madera

1-3/16"x21"

NUEVO



Usar en	Grano	Empaque piezas	No. Parte
Madera	40	Paquete con 5 Pzs	D-67066
Madera	60	Paquete con 5 Pzs	D-67072
Madera	80	Paquete con 5 Pzs	D-67088
Madera	100	Paquete con 5 Pzs	D-67094
Madera	120	Paquete con 5 Pzs	D-67103
Madera	150	Paquete con 5 Pzs	D-67119
Madera	180	Paquete con 5 Pzs	D-67125
Madera	240	Paquete con 5 Pzs	D-67131

Lijas de banda para madera, metal inox 3/8"x21"

Para lijadora 9032



Usar en	Grano	Empaque piezas	No. Parte
Madera	40	Paquete con 5 Pzs	P-43256
Madera	60	Paquete con 5 Pzs	P-43262
Madera	80	Paquete con 5 Pzs	P-43278
Madera	100	Paquete con 5 Pzs	P-43284
Madera	120	Paquete con 5 Pzs	P-43290
Madera	150	Paquete con 5 Pzs	P-43309
Madera	240	Paquete con 5 Pzs	P-43315
Madera	80	Paquete con 25 Pzs	P-39453
Metal inox	40	Paquete con 25 Pzs	P-39431
Metal inox	60	Paquete con 25 Pzs	P-39447
Metal inox	100	Paquete con 25 Pzs	P-39469
Metal inox	120	Paquete con 25 Pzs	P-39475

Lijas de banda para madera, metal inox 1- 3/16"x21"

Para lijadora 9032



Usar en	Grano	Empaque piezas	No. Parte
Madera	40	Paquete con 5 Pzs	P-36675
Madera	60	Paquete con 5 Pzs	P-36681
Madera	80	Paquete con 5 Pzs	P-36697
Madera	100	Paquete con 5 Pzs	P-36706
Madera	120	Paquete con 5 Pzs	P-36712
Madera	150	Paquete con 5 Pzs	P-36728
Madera	240	Paquete con 5 Pzs	P-36734
Madera	40	Paquete con 10 Pzs	A-91665-10
Madera	100	Paquete con 10 Pzs	A-91497-10
Madera	120	Paquete con 10 Pzs	A-91506-10
Metal inox	150	Paquete con 10 Pzs	A-91512-10
Metal inox	40	Paquete con 5 Pzs	P-00088
Metal inox	60	Paquete con 5 Pzs	P-00094
Metal inox	80	Paquete con 5 Pzs	P-00103
Metal inox	100	Paquete con 5 Pzs	P-00119
Metal inox	120	Paquete con 5 Pzs	P-00125
Metal inox	150	Paquete con 5 Pzs	P-00131

Lijas de banda para madera, vidrio 3"x18"



Usar en	Grano	Empaque Piezas	No. Parte
Madera	40	Paquete con 5 Pzs	P-37091
Madera	60	Paquete con 5 Pzs	P-37100
Madera	80	Paquete con 5 Pzs	P-37116
Madera	100	Paquete con 5 Pzs	P-37122
Madera	120	Paquete con 5 Pzs	P-37138
Madera	150	Paquete con 5 Pzs	P-37144
Madera	240	Paquete con 5 Pzs	P-37150
Madera	40/60/120	Paquete 3 Pzs 1 c/u	P-37166
Vidrio	180	Paquete con 10 Pzs	A-91958-10
Vidrio	220	Paquete con 10 Pzs	A-91964-10

Lijas de banda para piedra 1-3/16"x21"

Para lijadora 9032



Usar en	Grano	Empaque piezas	No. Parte
Piedra	40	Paquete con 5 Pzs	P-01395
Piedra	60	Paquete con 5 Pzs	P-01404
Piedra	80	Paquete con 5 Pzs	P-01199
Piedra	100	Paquete con 5 Pzs	P-01208
Piedra	120	Paquete con 5 Pzs	P-01214
Piedra	150	Paquete con 5 Pzs	P-01220
Piedra	180	Paquete con 5 Pzs	P-01236

Lijas línea estándar para madera, metal y PVC 3"x18"

Para lijadora 9011



NUEVO



Usar en	Grano	Empaque piezas	No. Parte
Madera, metal y PVC	40	Paquete con 3 Pzs.	D-59184
Madera, metal y PVC	60	Paquete con 3 Pzs.	D-59190
Madera, metal y PVC	80	Paquete con 3 Pzs.	D-59209
Madera, metal y PVC	100	Paquete con 3 Pzs.	D-59215
Madera, metal y PVC	120	Paquete con 3 Pzs.	D-59221
Madera, metal y PVC	150	Paquete con 3 Pzs.	D-59237
Madera, metal y PVC	180	Paquete con 3 Pzs.	D-59243
Madera, metal y PVC	240	Paquete con 3 Pzs.	D-59259

Lijas línea estándar Para madera, metal y PVC 3x21"



Usar en	Grano	Empaque piezas	No. Parte
Madera, metal y PVC	40	Paquete con 3 Pzs.	D-59265
Madera, metal y PVC	60	Paquete con 3 Pzs.	D-59271
Madera, metal y PVC	80	Paquete con 3 Pzs.	D-59287
Madera, metal y PVC	100	Paquete con 3 Pzs.	D-59293
Madera, metal y PVC	120	Paquete con 3 Pzs.	D-59302
Madera, metal y PVC	150	Paquete con 3 Pzs.	D-59318
Madera, metal y PVC	180	Paquete con 3 Pzs.	D-59324
Madera, metal y PVC	240	Paquete con 3 Pzs.	D-59330

Lijas de banda para metal 3"x24"



Usar en	Grano	Empaque piezas	No. Parte
Metal	60	Paquete con 10 Pzs.	A-91861-10
Metal	100	Paquete con 10 Pzs.	A-91880-10
Metal	120	Paquete con 10 Pzs.	A-91899-10

Lijas de banda para madera 3"x24"



NUEVO

Usar en	Grano	Empaque piezas	No. Parte
Madera	40	Paquete con 3 Pzs.	D-67147
Madera	60	Paquete con 3 Pzs.	D-67153
Madera	80	Paquete con 3 Pzs.	D-67169
Madera	100	Paquete con 3 Pzs.	D-67175
Madera	120	Paquete con 3 Pzs.	D-67181
Madera	150	Paquete con 3 Pzs.	D-67197
Madera	180	Paquete con 3 Pzs.	D-67206
Madera	240	Paquete con 3 Pzs.	D-67212

Lijas de banda para madera 3"x21"



Usar en	Grano	Empaque piezas	No. Parte
Madera	40	Paquete con 5 Pzs.	P-37172
Madera	60	Paquete con 5 Pzs.	P-37188
Madera	80	Paquete con 5 Pzs.	P-37194
Madera	100	Paquete con 5 Pzs.	P-37203
Madera	120	Paquete con 5 Pzs.	P-37219
Madera	150	Paquete con 5 Pzs.	P-37225
Madera	240	Paquete con 5 Pzs.	P-37231

Lijas de banda para madera 3"x24"



Usar en	Grano	Empaque piezas	No. Parte
Madera	40	Paquete con 5 Pzs.	P-37312
Madera	60	Paquete con 5 Pzs.	P-37328
Madera	80	Paquete con 5 Pzs.	P-37334
Madera	100	Paquete con 5 Pzs.	P-37340
Madera	120	Paquete con 5 Pzs.	P-37356
Madera	150	Paquete con 5 Pzs.	P-37362
Madera	240	Paquete con 5 Pzs.	P-37378
Madera	40	Paquete con 10 Pzs.	A-91780-10
Madera	50	Paquete con 10 Pzs.	A-91796-10
Madera	60	Paquete con 10 Pzs.	A-91805-10
Madera	80	Paquete con 10 Pzs.	A-91621-10
Madera	100	Paquete con 10 Pzs.	A-91637-10
Madera	120	Paquete con 10 Pzs.	A-91643-10

Lijas de banda para madera 3"x21"



Usar en	Grano	Empaque piezas	No. Parte
Madera	40	Paquete con 10 Pzs.	A-91746-10
Madera	40	Paquete con 25 Pzs.	P-37247
Madera	60	Paquete con 25 Pzs.	P-37253
Madera	80	Paquete con 25 Pzs.	P-37269
Madera	100	Paquete con 25 Pzs.	P-37275
Madera	120	Paquete con 25 Pzs.	P-37281
Madera	150	Paquete con 25 Pzs.	P-37297
Madera	240	Paquete con 25 Pzs.	P-37306

Lijas de banda para vidrio 3"x24"



Usar en	Grano	Empaque piezas	No. Parte
Vidrio	60	Paquete con 10 Pzs.	A-91970-10
Vidrio	80	Paquete con 10 Pzs.	A-91986-10
Vidrio	120	Paquete con 10 Pzs.	A-92003-10
Vidrio	180	Paquete con 10 Pzs.	A-92019-10
Vidrio	220	Paquete con 10 Pzs.	A-92025-10



Usar en	Grano	Empaque piezas	No. Parte
Madera	40	Paq. 5 Pzs.	P-36887
Madera	60	Paq. 5 Pzs.	P-36893
Madera	80	Paq. 5 Pzs.	P-36902
Madera	100	Paq. 5 Pzs.	P-36918
Madera	120	Paq. 5 Pzs.	P-36924
Madera	150	Paq. 5 Pzs.	P-36930
Madera	240	Paq. 5 Pzs.	P-36946
Madera	80	Paq. 10 Pzs.	A-91556-10

Lijas de banda para madera 4"x24"

Lijas de banda para madera 4"x24"



Usar en	Grano	Empaque piezas	No. Parte
Madera	150	Paq. 10 Pzs.	A-91578-10
Madera	40	Paq. 10 Pzs.	A-91724-10
Madera	40	Paq. 25 Pzs.	P-36952
Madera	60	Paq. 25 Pzs.	P-36968
Madera	80	Paq. 25 Pzs.	P-36974
Madera	100	Paq. 25 Pzs.	P-36980
Madera	120	Paq. 25 Pzs.	P-36996
Madera	150	Paq. 25 Pzs.	P-37007
Madera	240	Paq. 25 Pzs.	P-37013

Lijas línea estándar para madera, metal y PVC 4x24"



Usar en	Grano	Empaque piezas	No. Parte
Madera, metal y PVC	40	Paquete con 3 Pzs.	D-59346
Madera, metal y PVC	60	Paquete con 3 Pzs.	D-59352
Madera, metal y PVC	80	Paquete con 3 Pzs.	D-59368
Madera, metal y PVC	100	Paquete con 3 Pzs.	D-59374
Madera, metal y PVC	120	Paquete con 3 Pzs.	D-59380
Madera, metal y PVC	150	Paquete con 3 Pzs.	D-59396
Madera, metal y PVC	180	Paquete con 3 Pzs.	D-59405
Madera, metal y PVC	240	Paquete con 3 Pzs.	D-59411



9404

Lijadora de banda

Accesorios para lijadoras









	Usar en	Descripción	Empaque Pieza	No. Parte
	9901	Base de acero	1	343355-3
	BO4556	Base de fieltro	1	158323-1
	BO4556	Base de velcro	1	197465-6 197466-4
	BO5041	Filtro de velcro	1	196152-4
	BO5021	Borla de lana 5" con velcro	1	794560-9
	BO5030	Respaldo con velcro 5" 8 (Perforaciones)	1	743081-8
	BO5030	Esponja para pulir con velcro 5"	1	794558-6
	Pulidoras	Esponja para pulir con velcro 190mm Baja repulsión/ grueso	1	D-70786
	Pulidoras	Esponja para pulir con velcro 190mm Baja repulsión/ Medio	1	D-70792



BO4556

Lijadora orbital

Accesorios para lijadoras

	Usar en	Descripción	Empaque Pieza	No. Parte
	BO5010/ 5020/ 5021	5" Respaldo liso	1	743081-8
	BO6030/ BO6040	Respaldo con velcro 6" 6 (perforaciones)	1	196684-1
	SA7000C/ 9237C con adaptador D-57087	Bonete p/pulir 9" doble borla amarillo	1	D-57152
	pulidoras y lijadoras excéntricas	Bonete p/ pulir de lana 4" (100mm)	1	D-67000
	pulidoras y lijadoras excéntricas	Bonete p/ pulir de lana 6" (150mm)	1	D-65735
	pulidoras y lijadoras excéntricas	Bonete p/ pulir de lana 5" (125mm)	1	D-70867
	pulidoras y lijadoras	Bonete p/ pulir de lana, doble borla blanco 230mm (9")	1	D-70873
	pulidoras y lijadoras	Bonete p/ pulir de lana, doble borla amarillo 230mm (9")	1	D-70889



Conectores

	Aplicación	Usar en	Empaque piezas	No. Parte
	Adaptador bolsa a máquina	3901	1	415252-4
	Adaptador bolsa a máquina	9401	1	192613-2
	Seguro para bolsa	9901	1	410602-8

Complementos



Descripción	Usar en	Empaque piezas	No. Parte
Placa perforadora para lijas (plástica)	BO3710/3711	1	451271-6
Mango frontal	BO4051	1	451623-1
Base de empuñadura	BO5041	1	140440-1
Seguro	BO5041	1	451622-3

Respaldos, borlas y adaptadores



Usar en	Aplicación	Tipo	Diámetro	Empaque Piezas	No. Parte
Borla D-57071	Adaptador	Borla de lana	7"	1	D-57087
9227C/B,PV7001/C, PV7000C,SA7000C	Pulido de pinturas y poliéster	Borla de lana	7"	1	192629-7
9227C/B,PV7001/C, PV7000C,SA7000C	Pulido de pinturas y poliéster	Borla Lana con listón	7"	1	D-57071
9227C/B,PV7001/C, PV7000C,SA7000C	Para uso de borla con base de velcro	Respaldo con velcro	7"	1	743052-5
GV6010	Uso de borlas con listón y discos de lija.	Respaldo de goma	4"	1	743033-9
Esmeriles Angulares 4-1/2"	Uso de borlas con listón y discos de lija.	Respaldo de goma	5-1/2"	1	743036-3
PK5001C, PK5011C	Uso de borlas con listón y discos de lija.	Respaldo hule	5"	1	743015-1
GA7001L,GA7911, GV7000C,9067L,9077SL, 9069,92185B,9227C, 9227CY	Uso de borlas con listón y discos de lija.	Respaldo hule	7"	1	192978-2
GV5000	Para uso con discos abrasivos de tipo flexible	Respaldo de plástico	5"	1	743025-8

Accesorios para PO5000C

Esponjas de pulido

Diseño de celdas con estructura comprimida (CCS) que permite una operación mejorada más suave y fría



T-02674

Espuma europea de alta calidad con mayor resistencia al rasgado



Borde rebajado que evita el contacto con la superficie de pulido

	Medida	Forma	Tipo	Empaque pieza	No. Parte
	5-1/2"	Ondulado	Suave	1	T-02668
	5-1/2"	Ondulado	Medio	1	T-02674
	5-1/2"	Ondulado	Duro	1	T-02680
	100mm	Plano	Duro	1	D-62505
	125mm	Plano	Duro	1	D-62511
	150mm	Plano	Duro	1	D-62527
	100mm	Ondulado	Duro	1	D-62599
	125mm	Ondulado	Duro	1	D-62608
	150mm	Ondulado	Duro	1	D-62614
	100mm	Plano	Medio	1	D-62533
	125mm	Plano	Medio	1	D-62549
	150mm	Plano	Medio	1	D-62555
	100mm	Ondulado	Medio	1	D-62620
	125mm	Ondulado	Medio	1	D-62636
	150mm	Ondulado	Medio	1	D-62642
	100mm	Plano	Suave	1	D-62561
	125mm	Plano	Suave	1	D-62577
	150mm	Plano	Suave	1	D-62583
	100mm	Ondulado	Suave	1	D-62658
	125mm	Ondulado	Suave	1	D-62664
	150mm	Ondulado	Suave	1	D-62670

	Descripción	Empaque pieza	No. Parte
	Esponja 4"	1	197912-7
	Esponja 6"	1	197914-3
	Felpa 4"	1	197916-9
	Bonete para pulir 4"	1	197918-5
	Bonete para pulir 4-1/2"	1	197920-8
	Base de plástico con velcro 6"	1	197929-0
	Base de plástico con velcro 5"	1	197923-2



Bolsas para recolección de polvo



Aplicación	Usar en	Empaque piezas	No. Parte
Recolección del polvo de desecho generado durante el trabajo con la herramienta.	3901	1	122474-6
Recolección del polvo de desecho generado durante el trabajo con la herramienta.	9046	1	152456-4
Recolección del polvo de desecho generado durante el trabajo con la herramienta.	9401	1	122297-2
Recolección del polvo de desecho generado durante el trabajo con la herramienta.	9901	1	122329-5
Recolección del polvo de desecho generado durante el trabajo con la herramienta.	1911B	1	122402-1
Recolección del polvo de desecho generado durante el trabajo con la herramienta.	4014NV UB1101	1	122321-1
Recolección del polvo de desecho generado durante el trabajo con la herramienta.	9045N	1	122339-2
Recolección del polvo de desecho generado durante el trabajo con la herramienta.	9403, 9921	1	122562-9
Recolección del polvo de desecho generado durante el trabajo con la herramienta.	9900B, 9924DB	1	122296-4
Recolección del polvo de desecho generado durante el trabajo con la herramienta.	9910, 9911	1	122548-3
Recolección del polvo de desecho generado durante el trabajo con la herramienta.	BO3710	1	140115-2

Bolsas para recolección de polvo



Aplicación	Usar en	Empaque piezas	No. Parte
Recolección del polvo de desecho generado durante el trabajo con la herramienta.	BO4556	1	166078-4
Recolección del polvo de desecho generado durante el trabajo con la herramienta.	*	1	166079-2
Recolección del polvo de desecho generado durante el trabajo con la herramienta.	4093D BOLSA ANTIBACTERIAL	1	166084-9
Recolección del polvo de desecho generado durante el trabajo con la herramienta.	BO5021	1	151517-7
Recolección del polvo de desecho generado durante el trabajo con la herramienta.	LS1011	1	122351-2
Recolección del polvo de desecho generado durante el trabajo con la herramienta.	LS1016	1	122852-0
Recolección del polvo de desecho generado durante el trabajo con la herramienta.	PC1100	1	123203-0
Recolección del polvo de desecho generado durante el trabajo con la herramienta.	PC5001C	1	122853-8



BO4556
Lijadora orbital



RUEDAS FLAP

Especificaciones

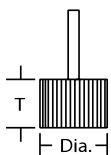

Aplicación



✓ Disponibles

Forma									
Diá. x T (mm)	25x25	38x25	50x25	50x38	50x50	64x25	75x25	75x50	75x50
Gruoso	#40	✓	✓	✓ (EN)	✓ (EN)	✓ (EN)	✓ (EN)	✓ (EN)	✓ (EN)
	#60	✓	✓	✓ (EN)	✓ (EN)	✓ (EN)	✓ (EN)	✓ (EN)	✓ (EN)
Medio	#80	✓	✓	✓ (EN)	✓ (EN)	✓ (EN)	✓ (EN)	✓ (EN)	✓ (EN)
	#120	✓	✓	✓ (EN)	✓ (EN)	✓ (EN)	✓ (EN)	✓ (EN)	✓ (EN)
Fino	#180	✓	✓	✓ (EN)	✓ (EN)	✓ (EN)	✓ (EN)	✓ (EN)	✓ (EN)

Diámetro	Longitud	Zanco	Grano	No. Parte
1"	1"	1/4"	60	B-38071
			80	B-38087
			120	B-38093
1-1/2"	1"	1/4"	60	B-38124
			80	B-38130
			60	B-38174
2"	1"	1/4"	80	B-38180
			120	B-38196

Diámetro	Longitud	Zanco	Grano	No. Parte
2"	1-1/2"	1/4"	60	B-38227
			80	B-38233
			120	B-38249
2"	2"	1/4"	60	B-38277
2-1/2"	1"	1/4"	60	B-38320
			80	B-38336
			60	B-38370
3"	1"	1/4"	80	B-38386
			120	B-38392



El equipo estándar (accesorios), las especificaciones y las fotografías pueden variar. Los accesorios pueden no estar incluidos desde origen con las herramientas, aunque se indiquen en este catálogo.





MULTIHERRAMIENTA



Carburo de tungsteno
grano #30



Filo de la cuchilla



Dientes puntiagudos



Carburo de tungsteno
grano #30



Filo de la cuchilla



Diente Japonés



Diamantado
grano #40



Base delta



Borde dentado



Base de lijado



NUEVAS CUCHILLAS

Especial para raspadura de concreto

HM disco cóncavo TMA027/ TMA028

Ambos lados de la cuchilla tienen grano de carburo de tungsteno que permite remover las rebabas de un nivel fuera de la superficie.

El borde de la hoja es curvo, no recto. Por eso, es fácil de establecer una posición que no resbale al contacto con los materiales.

En comparación con los resultados del corte fibra de vidrio, el tiempo de vida del grano de carburo de tungsteno del disco es de 10 veces más que el disco BIM.



Borde curvo



Cortando

Segmento de la cuchilla

TMA029

Profundidad de corte 25mm

Cortes limpios y rápidos en material suave

Gracias a la hoja BiM, su vida útil es más larga que la HCS



Juegos



Juego para azulejo 1



Juego para azulejo 2



Juego de piso 1



Juego de piso 2



Juego de cuchillas de penetración



Juego de carpintería

Identificadores de materiales

Para una rápida sugerencia del accesorio



Adaptador para accesorios Dremel

	Descripción	Piezas empaque	No. parte
	Adaptador para accesorios Dremel	1	313249-6

Accesorios para multiherramienta con sujeción Starlock



Cuchillas segmentadas Starlock



No.	Tipo	No. Parte
TMA045	Cuchilla segmentada 85	B-64799
TMA046	Cuchilla segmentada 100	B-64808
TMA049	Cuchilla segmentada 85	B-64836
TMA069	Cuchilla segmentada 85	B-65028
TMA070	Cuchilla segmentada 85	B-65034
TMA071	Cuchilla segmentada 70	B-65040
TMA072	Cuchilla segmentada 85	B-65056

Cuchilla bimetalica Starlock



No.	Tipo	No. Parte
TMA047	Cuchilla bimetalica 32	B-64814
TMA048	Cuchilla bimetalica 65	B-64820
TMA053	Cuchilla bimetalica 32	B-64870
TMA055	Cuchilla bimetalica 65	B-64892
TMA055	Cuchilla bimetalica 65	B-64901
TMA057	Cuchilla bimetalica 10	B-64917
TMA058	Cuchilla bimetalica 20	B-64923
TMA059	Cuchilla bimetalica 32	B-64939

Cuchilla HCS Starlock



No.	Tipo	No. Parte
TMA050	Cuchilla HCS 25	B-64842
TMA051	Cuchilla HCS 32	B-64858
TMA052	Cuchilla HCS 65	B-64864
TMA054	Cuchilla HCS 32	B-64886

Cuchilla carburo Starlock



No.	Tipo	No. Parte
TMA060	Cuchilla carburo 20	B-64945
TMA061	Cuchilla carburo 32	B-64951

Sierra segmentada Starlock



No.	Tipo	No. Parte
TMA063	Sierra segmentada 100	B-64967
TMA064	Sierra segmentada 85	B-64973

Raspador Starlock



No.	Tipo	No. Parte
TMA065	Raspador rigido	B-64989
TMA066	Raspador flexible	B-64995

Cuchilla corte de uniones Starlock



No.	Tipo	No. Parte
TMA067	Cuchilla corte de uniones	B-65006

Multicortador Starlock



No.	Tipo	No. Parte
TMA068	Multicortador	B-65012

Plato de lijado Starlock



No.	Tipo	No. Parte
TMA073	Plato de lijado 78	B-65062

Removedor de carburo Starlock

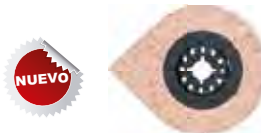

No.	Tipo	No. Parte
TMA074	Removedor de carburo 70	B-65078

Cuchilla grano carburo Starlock



No.	Tipo	No. Parte
TMA075	Cuchilla grano carburo 32	B-65084

Lijador de carburo Starlock



No.	Tipo	No. Parte
TMA076	Lijador de carburo 32	B-65090
TMA077	Lijador de carburo 32	B-65109

Almohadilla de lijado Starlock



No.	Tipo	No. Parte
TMA078	Almohadilla de lijado 94	B-65115

Sets de cuchillas Starlock



No.	Tipo	No. Parte
	Set de cuchillas de inmersión	B-67480
	Set de cuchillas para azulejo	B-67496
	Set de cuchillas para piso	B-67505
	Set de cuchillas para carpintería	B-67511





TABLA DE APLICACIONES DE LIJA PARA MULTIHERRAMIENTA

Calificación de aplicación idónea:

AA: Especialmente adecuado

A = adecuado

n.r = no aplica

		Grano	Pintura	Barniz	Empasté	Mezcla gruesa	Madera/ materiales de madera	Madera suave	Madera dura	Enchapado	Aglomerado / MDF	Fibra de vidrio refuerzo plástico	Metales	Acero (acero dulce / acero al carbón)	Piedra	Mármol	Granito	Vidrio	Plexiglas	Corian	Plástico reforzado		
Madera / larga vida	Grueso	60																					
		80																					
	Medio	100	n.r	n.r	n.r	n.r	AA	AA	AA	AA	AA	A	AA	A	n.r	n.r	n.r	n.r	n.r	n.r	n.r	n.r	
		120																					
	Finos	180																					
		240																					
Madera	Grueso	60																					
		80																					
	Medio	100																					
		120	n.r	n.r	n.r	n.r	AA	A	AA	AA	AA	A	n.r	n.r	n.r	n.r	n.r	n.r	n.r	n.r	n.r	n.r	
	Finos	150																					
		180																					
Pintura	Grueso	60																					
		80																					
	Medio	100																					
		120	AA	AA	AA	AA	n.r	n.r	A	n.r	n.r	n.r	A	A	n.r	n.r	n.r	n.r	n.r	n.r	n.r	n.r	
	Finos	240																					
		320																					
Piedra	Medio	120																					
		240																					
	Finos	400	A	AA	n.r	n.r	n.r	n.r	n.r	n.r	n.r	n.r	n.r	n.r	A	A	A	A	A	A	A	A	
		600																					
	Muy fino	1200																					

Papel abrasivo tipo Delta

Para uso con disco de lija (B-21537) (Tipo gancho y bucle)

Madera / larga vida

Adecuado para lijar madera, madera dura, tableros de partículas, tableros de construcción y metal



Tamaño del papel (mm)	Grano	Empaque piezas	No. Parte
93	60	10	B-21565
93	80	10	B-21571
93	100	10	B-21587
93	120	10	B-21593
93	180	10	B-21602
93	240	10	B-22931
93	60,80,100,120,180	10(2 piezas de cada uno)	B-21559

Piedra

Adecuado para lijar o dar brillo a materiales extremadamente duros como piedra o vidrio



Tamaño del papel (mm)	Grano	Empaque Piezas	No. Parte
93	120	10	B-21749
93	240	10	B-21755
93	400	10	B-21761
93	600	10	B-21777
93	1200	10	B-21783
93	120,240,400,600,1200	10 (2piezas de cada uno)	B-21733

Madera

Lijar maderas y piezas de madera



Tamaño del papel (mm)	Grano	Empaque piezas	No. Parte
93	60	10	B-21624
93	80	10	B-21630
93	100	10	B-22947
93	120	10	B-21646
93	150	10	B-22953
93	180	10	B-21652
93	60,80,120,180,240	10(2 piezas de cada uno)	B-21618

Base Delta para multicortadores y lijadoras de acabados

Modelo (BO4565, Lijadora de acabado)



Madera

Grano	Empaque piezas	No. Parte
40	10	P-33255
60	10	P-33261
80	10	P-33277
100	10	P-33283
120	10	P-33299
150	10	P-33308
180	10	P-33314
240	10	P-33320
320	10	P-33336

Pintura

Adecuado para lijar madera y materiales hechos de madera



Tamaño del papel (mm)	Grano	Empaque piezas	No. Parte
93	60	10	B-21680
93	100	10	B-21705
93	120	10	B-22969
93	240	10	B-21711
93	320	10	B-21727
93	60,80,100,240,320	10(2piezas de cada uno)	B-21674

Lana para remover oxido

Adecuado para pulir Oxido



Tamaño del papel (mm)	Grano	Empaque piezas	No. Parte
93	280	1	B-21799
93	100	1	B-21808
93	S/G	1	B-21814

Pintura

Grano	Empaque piezas	No. Parte
40	10	P-42684
60	10	P-42690
80	10	P-42709
120	10	P-42721

Filtro para pulir

Adecuado para pulir



Tamaño del papel (mm)	Grano	Empaque piezas	No. Parte
93	S/G	1	B-21820



DISCOS DE DIAMANTE



Rosca / diámetro



Seco



Diámetro /
Diámetro interno



No permite el
desbaste por cara





















Velocidad máxima

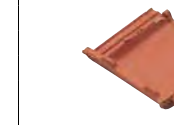

Humédo

DISCOS DE DIAMANTE

Material

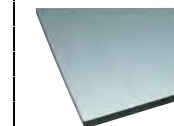
Material no. 1						
Concreto duro	Granito	Gneis	Suavizador e ingeniería	Pizarra de carbono	Vereda de pizarra	Bloque de ingeniería / Bloque de ingeniería clase 2
						
Material no. 2			Material no. 3			
Concreto	Bloque	Ranura en forma de U	Vereda en bloques	Azulejo cementado	Mármol	Sin esmaltar
						
	Material no. 4		Material no. 5	Material no. 6	Material no. 7	
Ladrillo	Bloque agregado	Azulejo frances	Asfalto	Azulejo	Vidrio	
						



El equipo estándar (accesorios), las especificaciones y las fotografías pueden variar.
Los accesorios pueden no estar incluidos desde origen con las herramientas, aunque se indiquen en este catálogo.

TIPOS DE DISCOS DE DIAMANTE

**Disco segmentado**

Más comúnmente usado.
La hoja tiene ranuras y capas de diamante en los bordes.
Corta más rápido que el rín continuo alcanzando una superficie de corte promedio

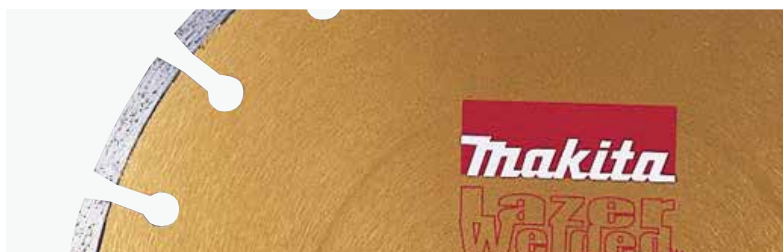
**Disco segmentado por láser soldado**

La capa de diamante y la placa se soldan con un rayo láser de 1000°C. Ideal para máquinas de alta potencia gracias a la unión de la aleación del diamante y la placa

No disponible en México

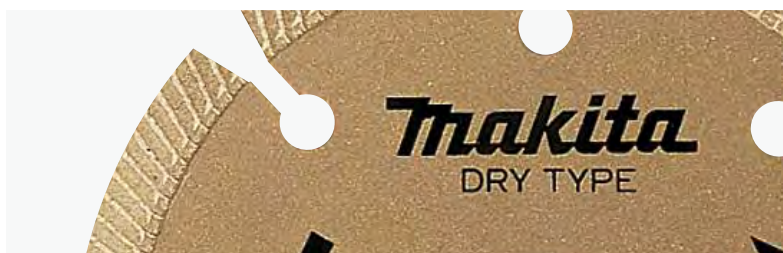
**Disco turbo segmentado**

Cada segmento tiene muescas (ola), este diseño proporciona:

- Cortes rápidos y menos resistencia del material
- Eliminación de residuos suaves
- Menos carga en el disco

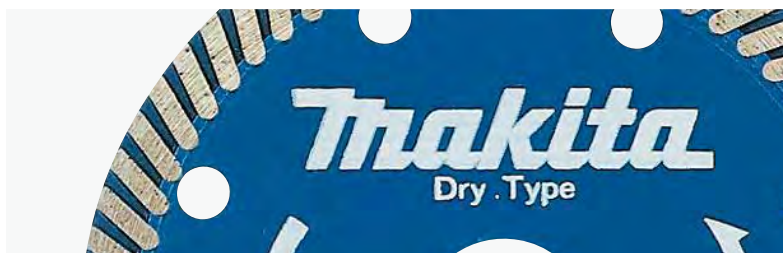
**Disco turbo**

Con muescas alrededor del disco Proporciona:

- Corte más rápido
- Alcanza una superficie más limpia

**Disco rín continuo**

Capa de diamant con un espesor uniforme alrededor de todo el borde.

- Puede alcanzar una superficie más limpia, incluso en materiales crujientes y quebradizos.
- Corte preciso pero lento

**Disco de diamante electrodepositado**

- Diamantes más expuestos
- Corte más rápido y eficiente

COPAS DE DIAMANTE

D-60676 (4 1/2") D-60682 (5")



Aplicación en trabajos de construcción y decoración
Desbaste en PISO y PARED



Copa de diamante
línea estándar

Para concreto
Uso en SECO

Para uso en miniesmeriladoras*
 y aplanadoras de concreto
 (No. parte D-60676 se recomienda para
 miniesmeriladoras con tecnología SJS
 o de arranque suave)

(Modelos: 9564CVR / 9564PC / 9564PZ)



* Es recomendable utilizar la cubierta para polvo
 por seguridad del usuario y para evitar el exceso de polvo.

No. parte 195236-5



Descripción	Grosor del segmento	Diámetro externo	Diámetro interno	Aplicación	Uso	No. parte
Copa de diamante segmentado	4x8mm	4"	7/8"	Desbaste de concreto	Seco	B-14629
Copa de diamante segmentado	4x8mm	4 1/2"	7/8"	Desbaste de concreto * Para esmeril 4 1/2"	Seco	D-60676
Copa de diamante segmentado	7x5mm	5"	7/8"	Desbaste de concreto	Seco	D-41458
Copa de diamante segmentado	5x8mm	5"	7/8"	Desbaste de concreto	Seco	B-12295
Copa de diamante segmentado	7x5mm	5"	7/8"	Desbaste de concreto Para esmeril 5"	Seco	D-60682
Copa de diamante segmentado	7x5mm	7"	7/8"	Desbaste de concreto	Seco	D-62290
Copa de diamante doble segmentado	7x5mm	4 1/2"	7/8"	Desbaste de concreto	Seco	D-62315
Copa de diamante doble segmentado	7x5mm	5"	7/8"	Desbaste de concreto Para esmeril 5", PC5000C, PC5001C	Seco	D-66715
Copa de diamante doble segmentado	7x5mm	7"	7/8"	Desbaste de concreto	Seco	D-62321
Copa de diamante turbo	7x5mm	4 1/2"	7/8"	Desbaste de concreto	Seco	D-62343
Copa de diamante turbo	7x5mm	5"	7/8"	Desbaste de concreto Para esmeril 5", PC5000C, PC5001C	Seco	D-66721
Copa de diamante turbo	7x5mm	7"	7/8"	Desbaste de concreto	Seco	D-62359
Copa de diamante liso	13x5mm	5"	7/8"	Especial desbaste de mármol	Seco	D-41464

Desbaste

Disco diamantado angular

Seco

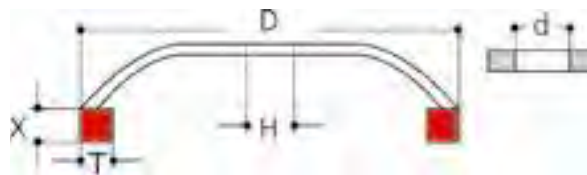

AA: Especialmente adecuado, A: adecuado

(EN) : EN13236

	Aplicacion	D	T	X	H	d	Color	Para material							Para Modelo	No. Parte
								1	2	3	4	5	6	7		
	Para uso general	110	13.5	4	15	-	Azul	AA	AA	AA	A	A			PC1100	A-07369(EN)
	Para acabados finos Especial p/ mármol y granito	125	13.5	4	22.23	-	Oro	AA	AA	AA	A	A			PC5000, 5001C	B-12289(EN)
	Para acabados finos	110	8	5	15	-	Plata	AA	AA	AA	A	A			PC1100	A-86321(EN)
	Para acabados finos Especial p/ mármol y granito	125	8	5	23.23	-	Oro	AA	AA	AA	A	A			PC5000, 5001C	B-12295(EN)

Línea industrial “Baja vibración”

	Descripción	Diámetro	Diámetro interior	Uso	Materiales a Trabajar	No. Parte
	Copa de diamante segmentado	5"	M14	Seco	Concreto, ladrillo	B-48533
	Copa de diamante doble segmentado	5"	M14	Seco	Concreto, ladrillo	B-48549
	Disco de diamante boomerang	5"	M14	Seco	Concreto, ladrillo	B-48555
	Copa de diamante segmentado	5"	7/8"	Seco	Concreto, ladrillo	B-48561
	Copa de diamante doble segmentado	5"	7/8"	Seco	Concreto, ladrillo	B-48577
	Disco de diamante Boomerang	5"	7/8"	Seco	Concreto, ladrillo	B-48583
	Copa de diamante segmentado	7"	M14	Seco	Concreto, ladrillo	B-48599
	Copa de diamante doble segmentado	7"	M14	Seco	Concreto, ladrillo	B-48608
	Disco de diamante Boomerang	7"	M14	Seco	Concreto, ladrillo	B-48614
	Copa de diamantada turbo fino	7"	7/8"	Seco	Concreto, ladrillo	B-50005
	Copa de diamante segmentado	7"	7/8"	Seco	Concreto, ladrillo	B-48636
	Copa de diamante doble segmentado	7"	7/8"	Seco	Concreto, ladrillo	B-48642
	Disco de diamante Boomerang	7"	7/8"	Seco	Concreto, ladrillo	B-48658

Línea económica

Esmeriladoras 5", 7"

	Descripción	Diámetro	Diámetro interior	Grosor del segmento	Uso	Materiales a Trabajar	No. Parte
	Disco copa diamantada	5"	7/8"		Seco	Limpieza de linoleum y pintura	B-53160
	Disco copa diamantada	7"	7/8"		Seco	Limpieza de linoleum y pintura	B-53176

Línea profesional

Esmeriladoras 5", 7"

	Descripción	Diámetro	Diámetro interior	Grosor del Segmento	Uso	Materiales a Trabajar	No. Parte
	Copa de diamante liso	5"	7/8"	13x4mm	Seco	Especial para Mármol	B-12289
	Copa de diamante turbo (Baja vibración)	7"	M14		Seco	Especial para Mármol	B-48620
	Copa de diamante turbo (Baja vibración)	7"	7/8"		Seco	Especial para Mármol	B-48664

Especiales para cortadora de vidrio

	Descripción	Diámetro	Diámetro interior	Grosor del Segmento	Uso	Materiales a Trabajar	No. Parte
	Disco de diamante segmentado Tipo dentado p/ 4190DW	3 3/8"	7/8"		Humedo	Especial para vidrio, Azulejos, Mármol y granito	A-07179
	Disco de diamante liso Rín continuo p/ 4190DW	3 3/8"	7/8"		Humedo	Especial para Azulejos, Cerámica, Mármol y vidrio	A-01323

Segmentados

Línea estándar

NUEVO

Esmeriladoras, Cortadoras

	Descripción	Diámetro	Diámetro interior	Grosor del Segmento	Uso	Materiales a Trabajar	No. Parte
	Disco de diamante segmentado	4"	20mm Reductor de 16mm	12mm	Humedo /Seco	Concreto, tabicón, cantera, ladrillo	D-74083
	Disco de diamante segmentado	4-1/2"	7/8" (22.23mm)	12mm	Humedo /Seco	Concreto, tabicón, cantera, ladrillo	D-74099
	Disco de diamante segmentado	5"	7/8" (22.23mm) Reductor de 20mm	12mm	Humedo /Seco	Concreto, tabicón, cantera, ladrillo	D-74108
	Disco de diamante segmentado	7"	1" (25.4) Reductor de 22.23mm	12mm	Humedo /Seco	Concreto, tabicón, cantera, ladrillo	D-74114
	Disco de diamante segmentado	9"	7/8"	12mm	Humedo /Seco	Concreto, tabicón, cantera, ladrillo	D-74120

Línea estándar

Esmeriladoras 4-1/2", 7", 9"

	Descripción	Diámetro	Diámetro interior	Grosor del Segmento	Uso	Materiales a Trabajar	No. Parte
	Disco de diamante segmentado	4 1/2"	7/8"	1.8mm	Seco	Concreto, tabicón, cantera, ladrillo	D-44270
	Disco de diamante segmentado	7"	7/8"	2.2mm	Seco	Concreto, tabicón, cantera, ladrillo	D-44286
	Disco de diamante segmentado	9"	7/8"	2.4mm	Seco	Concreto, tabicón, cantera, ladrillo	D-44292
	Disco de diamante segmentado	4 1/2"	7/8"	1.8mm	Seco	Concreto, tabicón, cantera, ladrillo	D-44270-10
	Disco de diamante segmentado	7"	7/8"	2.2mm	Seco	Concreto, tabicón, cantera, ladrillo	D-44286-10
	Disco de diamante segmentado	9"	7/8"	2.4mm	Seco	Concreto, tabicón, cantera, ladrillo	D-44292-10
	Disco de diamante segmentado	4 1/8"	7/8"		Seco-humedo	Concreto, tabicón, cantera, ladrillo	D-05197-10

El equipo estándar (accesorios), las especificaciones y las fotografías pueden variar. Los accesorios pueden no estar incluidos desde origen con las herramientas, aunque se indiquen en este catálogo.

Línea estándar "Long life" especial para cantera

Esmeriladoras 4-1/2", 5", 7", 9"

	Descripción	Diámetro	Diámetro interior	Grosor del Segmento	Uso	Materiales a Trabajar	No. Parte
	Disco de diamante segmentado	4-1/2"	7/8"	2mm	Seco	Concreto, tabicón, cantera, ladrillo	D-37552
	Disco de diamante segmentado	5"	7/8"	2.2mm	Seco	Concreto, tabicón, cantera, ladrillo	D-37568
	Disco de diamante segmentado	5"	20mm	2mm	Seco	Especial para concreto	D-38261
	Disco de diamante segmentado	7"	7/8"	2.4mm	Seco	Concreto, tabicón, cantera, ladrillo	D-37574
	Disco de diamante segmentado	7"	7/8"	2.4mm	Seco	Concreto, tabicón, cantera, ladrillo	D-37574-10

Línea profesional

Esmeriladoras 4-1/2", 5", 7", 9"

	Descripción	Diámetro	Diámetro interior	Grosor del Segmento	Uso	Materiales a Trabajar	No. Parte
	Disco de diamante segmentado	4-1/2"	7/8"	1.9mm	Seco	Concreto, tabicón, cantera, ladrillo, asfalto	A-84109
	Disco de diamante segmentado	5"	7/8"	1.9mm	Seco	Concreto, tabicón, cantera, ladrillo, asfalto	A-84115
	Disco de diamante segmentado	7"	7/8"	2.3mm	Seco	Concreto, tabicón, cantera, ladrillo, asfalto	A-84121
	Disco de diamante segmentado	9"	7/8"	2.5mm	Seco	Concreto, tabicón, cantera, ladrillo, asfalto	A-84137

Línea industrial "láser"

Esmeriladoras 4-1/2", 5", 7", 9"

	Descripción	Diámetro	Diámetro interior	Grosor del Segmento	Uso	Materiales a Trabajar	No. Parte
	Disco de diamante segmentado	7"	7/8"	2.2mm	Seco	Concreto, concreto duro, tabicón, cantera, ladrillo, asfalto	D-44404
	Disco de diamante segmentado	9"	7/8"	2.4mm	Seco	Concreto, concreto duro, tabicón, cantera, ladrillo, asfalto	D-44410

Cortadora de concreto a gasolina

Línea económica

	Descripción	Diámetro	Diámetro interior	Grosor del Segmento	Uso	Materiales a Trabajar	No. Parte
	Disco de diamante segmentado	12"	1"	3mm	Seco	Concreto, tabicón, cantera, ladrillo	D-56982
	Disco de diamante segmentado	14"	1"	4mm	Seco	Concreto, tabicón, cantera, ladrillo	D-56998
	Disco de diamante segmentado	16"	1"	4mm	Seco	Concreto, tabicón, cantera, ladrillo	D-57009

Línea estándar

	Descripción	Diámetro	Diámetro interior	Grosor del Segmento	Uso	Materiales a Trabajar	No. Parte
	Disco de diamante segmentado	14"	1" Red (20mm)	4mm	Humedo	Concreto, tabicón, cantera, ladrillo	A-94736

Cortadora de concreto a gasolina

Línea industrial (Quasar)









	Descripción	Diámetro	Diámetro interior	Grosor del Segmento	Uso	Materiales a Trabajar	No. Parte
	Disco de diamante segmentado corte metal	12"	20mm	3mm	Humedo seco	Concreto, cantera, ladrillo	B-13459
	Disco de diamante segmentado corte metal	14"	1"	3mm	Humedo seco	Concreto, cantera, ladrillo	B-13465
	Disco de diamante segmentado corte metal	16"	1"	3mm	Humedo seco	Concreto, cantera, ladrillo	B-13471

2414NB/MLC141

Línea profesional

	Descripción	Diámetro	Diámetro interior	Grosor del Segmento	Uso	Materiales a Trabajar	No. Parte
	Disco de diamante segmentado corte metal	14"	1"	3mm	Seco	Metal, varilla, tubular, perfil, ángulo	D-41414
	Disco de diamante segmentado corte metal "Fast Cut"	14"	1"	3mm	Seco	Metal, varilla, tubular, perfil, ángulo	B-29511

Línea estándar

*Con reductor a 5/8"	Descripción	Diámetro	Diámetro interior	Grosor del Segmento	Uso	Materiales a Trabajar	No. Parte
	Disco de diamante segmentado	4" (100mm)	20mm	2mm	Seco	Especial para concreto	D-42531
	Disco de diamante segmentado	4" (100mm)	20mm	2mm	Seco	Especial para granito y mármol	D-63688
	Disco de diamante segmentado	4-1/2" (115mm)	7/8" (22.23 mm)	2mm	Seco	Especial para porcelana	D-65109
	Disco de diamante segmentado	105mm	20mm	9 mm Anillo de 16mm	Seco	Especial para Concreto	D-71009
	Disco de diamante segmentado	4-1/2" (115mm)	7/8" 22.23 mm	9 mm	Seco	Especial para Concreto	D-71015
	Disco de diamante segmentado	125mm	7/8" 22.23 mm	9 mm Anillo de 20mm	Seco	Especial para Concreto	D-71021
	Disco de diamante segmentado	9" (230mm)	7/8" 22.23 mm	13 mm	Seco	Especial para Concreto Ideal para cortadoras de concreto inalámbricas 	E-02967
	Disco de diamante segmentado	14" (355mm)	1" (25.4 mm)	8 mm	Seco	Especial para Concreto Ideal para cortadoras de concreto inalámbricas 	NUEVO E-12996

Línea estándar / concavos, cortes curvos

Especial para "4100-4102NH,-4100NS

	Descripción	Diámetro	Diámetro interior	Grosor del Segmento	Uso	Materiales a Trabajar	No. Parte
	Disco de diamante segmentado concavo	4-3/8"	20mm	2.5mm	Humedo	Azulejo, mármol, adoquín, granito	D-30623

El equipo estándar (accesorios), las especificaciones y las fotografías pueden variar. Los accesorios pueden no estar incluidos desde origen con las herramientas, aunque se indiquen en este catálogo.

Línea multimateriales

Esmeriladores 4-1/2", 7", 9"

	Descripción	Diámetro	Diámetro interior	Grosor del Segmento	Uso	Materiales a Trabajar	No. Parte
	Disco de diamante segmentado multimateriales	4-1/2"	7/8"	1.8mm	Seco	Concreto, metal, PVC	D-58883
	Disco de diamante segmentado multimateriales	7"	7/8"	1.8mm	Seco	Concreto, metal, PVC	D-58899
	Disco de diamante segmentado multimateriales	9"	7/8"	2.0mm	Seco	Concreto, metal, PVC	D-58908

Línea industrial, diamante electrodepositado

Esmeriladores 4-1/2", 7", 9"

	Descripción	Diámetro	Diámetro interior	Grosor del Segmento	Uso	Materiales a Trabajar	No. Parte
	Disco de diamante electrodepositado	4-1/2"	7/8"	1.3mm	Seco	Concreto, tubo PVC, metal no ferroso, inox	B-53687
	Disco de diamante electrodepositado	7"	7/8"	1.6mm	Seco	Concreto, tubo PVC, metal no ferroso, inox	B-53702
	Disco de diamante electrodepositado	9"	7/8"	1.6mm	Seco	Concreto, tubo PVC, metal no ferroso, inox	B-53718

Rin Continuo / lisos

Línea estándar

Especial para "4100-4102NH,-4100NS

*Con reductor a 5/8"

	Descripción	Diámetro	Diámetro interior	Grosor del Segmento	Uso	Materiales a Trabajar	No. Parte
	Disco de diamante rin continuo	4-3/8"	20mm	2mm	Humedo	Especial para azulejo	D-44258
	Disco de diamante rin continuo	4"	20mm	2mm	Humedo	Concreto, tabique, mármol, azulejo	D-05212

Línea estándar

Herramienta estacionaria

	Descripción	Diámetro	Diámetro interior	Grosor del Segmento	Uso	Materiales a Trabajar	No. Parte
	Disco de diamante rin continuo	7"	1"	2.2mm	Humedo	Mármol, azulejo	D-41436
	Disco de diamante rin continuo	8"	1"	2.2mm	Humedo	Mármol, azulejo	D-41442
	Disco de diamante rin continuo	7"	1"	2mm	Humedo	azulejo	D-44264



Línea estándar

Esmeriladoras 4-1/2"

	Descripción	Diámetro	Diámetro interior	Grosor del Segmento	Uso	Materiales a Trabajar	No. Parte
	Disco de diamante rin continuo	4-1/2"	7/8"	17mm	Seco	Azulejo, mármol, granito	D-36837

Línea profesional

Especial para "4100-4102NH-4100NS

Descripción	Diámetro	Diámetro interior	Grosor del Segmento	Uso	Materiales a Trabajar	No. Parte
 Disco de diamante rin continuo	4-3/8"	20mm	1.8mm	Humedo	Especial para porcelana	B-22925
 Disco de diamante rin continuo	4-3/8"	20mm	2mm	Humedo	Especial para mármol, concreto y granito	D-45004

Línea profesional

Especial para "4100-4102NH-4100NS

*Con reductor a 5/8"	Descripción	Diámetro	Diámetro interior	Grosor del Segmento	Uso	Materiales a Trabajar	No. Parte
 Disco de diamante rin continuo	Disco de diamante rin continuo	4-3/8"	20mm	2mm	Humedo	Especial para mármol (diamante electrodepositado)	D-38277
 Disco de diamante rin continuo	Disco de diamante rin continuo	4-3/8"	20mm	1.2mm	Humedo	Especial para vidrio	D-40705

Línea industrial diamante electrodepositado

Esmeriladoras 4-1/2", 7", 9"

Descripción	Diámetro	Diámetro interior	Grosor del Segmento	Uso	Materiales a Trabajar	No. Parte
 Disco de diamante rin continuo	4-1/2"	7/8"	1.3mm	Seco	Granito, asfalto	D-51085
Disco de diamante rin continuo	7"	7/8"	1.6mm	Seco	Granito, asfalto	D-51091
Disco de diamante rin continuo	9"	7/8"	1.3mm	Seco	Granito, asfalto	D-51100

Turbo

Línea económica

Esmeriladoras 4-1/2", 7", 9"

Descripción	Diámetro	Diámetro interior	Grosor del Segmento	Uso	Materiales a Trabajar	No. Parte
 Disco de diamante turbo	4-1/2"	7/8"	1.8mm	Seco	Concreto, mármol, azulejo	D-44301
Disco de diamante turbo	7"	7/8"	2.2mm	Seco	Concreto, mármol, azulejo	D-44317
Disco de diamante turbo	9"	7/8"	2.4mm	Seco	Concreto, mármol, azulejo	D-44323

Línea estándar

Especial para "4100-4102NH,-4100NS

*Con reductor a 5/8"	Descripción	Diámetro	Diámetro interior	Grosor del Segmento	Uso	Materiales a Trabajar	No. Parte
 Disco de diamante turbo	Disco de diamante turbo	4"	20mm	2mm	Seco	Especial para granito, mármol	D-42553

El equipo estándar (accesorios), las especificaciones y las fotografías pueden variar. Los accesorios pueden no estar incluidos desde origen con las herramientas, aunque se indiquen en este catálogo.

Línea estándar / Turbo segmentado

Especial para "4100-4102NH,-4100NS

*Con reductor a 5/8"

	Descripción	Diámetro	Diámetro interior	Grosor del Segmento	Uso	Materiales a Trabajar	No. Parte
	Disco de diamante turbo-segmentado	4"	20mm	2mm	Seco	Especial para concreto, granito	D-42581

Línea estándar / Concavos, cortes curvos

Especial para "4100-4102NH,-4100NS

*Con reductor a 5/8"

	Descripción	Diámetro	Diámetro interior	Grosor del Segmento	Uso	Materiales a Trabajar	No. Parte
	Disco de diamante turbo concavo	4-3/8"	20mm	2.5mm	Seco	Mármol, tabicón, concreto, adoquín	D-36968

Especial para "4100-4102NH,-4100NS

	Descripción	Diámetro	Diámetro interior	Grosor del Segmento	Uso	Materiales a Trabajar	No. Parte
	Disco de diamante turbo concavo	4-3/8"	20mm	2.5mm	Humedo	Azulejo, mármol, adoquín, granito	D-30639

Línea estándar "Long life"

Esmeriladoras 4-1/2", 5", 7", 9"

	Descripción	Diámetro	Diámetro interior	Grosor del Segmento	Uso	Materiales a Trabajar	No. Parte
	Disco de diamante turbo	4-1/2"	7/8"	2mm	Seco	Concreto, mármol, azulejo	D-37596
	Disco de diamante turbo	5"	7/8"	2.2mm	Seco	Concreto, mármol, azulejo	D-37605
	Disco de diamante turbo	7"	7/8"	2.4mm	Seco	Concreto, mármol, azulejo	D-37611
	Disco de diamante turbo	9"	7/8"	2.6mm	Seco	Concreto, mármol, azulejo	D-37627

Línea profesional

Especial para "4100-4102NH,-4100NS

	Descripción	Diámetro	Diámetro interior	Grosor del Segmento	Uso	Materiales a Trabajar	No. Parte
	Disco de diamante turbo para concreto, granito	5"	20mm	2.6mm	Humedo	Especial para concreto, granito	B-16748

Esmeriladoras 4-1/2", 5", 7", 9"

	Descripción	Diámetro	Diámetro interior	Grosor del Segmento	Uso	Materiales a Trabajar	No. Parte
	Disco de diamante turbo	4-1/2"	7/8"	2mm	Seco	Concreto	A-84143
	Disco de diamante turbo	4-1/2"	7/8"	2.3mm	Seco	Granito, asfalto	A-84056
	Disco de diamante turbo	5"	7/8"	2.1mm	Seco	Concreto	A-84159
	Disco de diamante turbo	7"	1"	2.3mm	Seco	Concreto	A-84165
	Disco de diamante turbo	9"	7/8"	2.6mm	Seco	Concreto	A-84171
	Disco de diamante turbo	4-1/2"	7/8"	1.4mm	Humedo / seco	Porcelana, cerámica	B-46327
	Disco de diamante turbo	5"	7/8"	1.4mm	Humedo / seco	Porcelana, cerámica	B-46333

Línea industrial "ultra delgado"

Esmeriladoras 4-1/2", 7"

	Descripción	Diámetro	Diámetro interior	Grosor del Segmento	Uso	Materiales a Trabajar	No. Parte
	Disco de diamante turbo	4-1/2"	7/8"	1.3mm	Seco	Porcelana	D-50893
	Disco de diamante turbo	7"	7/8"	1.6mm	Seco	Porcelana	D-50902

LÍNEA DE RESCATE

• Disco de diamante electrodepositado

Accesorios para utilizar con herramienta inalámbrica, miniesmeril o cortadora a gasolina en **LABORES DE RESCATE**

Capaz de cortar diversos materiales como metal, concreto, resina y vidrio templado (MULTIMATERIAL)



Granulado del disco soldado directamente sobre la base del disco

Descripción	Piezas empaque	No. parte
Disco de diamante Electrodepositado 4" Multi P/Rescate	1	B-66933
Disco de diamante Electrodepositado 4 1/2" Multi P/Rescate	1	B-55304
Disco de diamante Electrodepositado 7" Multi P/Rescate	1	B-66949
Disco de diamante Electrodepositado 9" Multi P/Rescate	1	B-55326
Disco de diamante Electrodepositado 14" Multi P/Rescate	1	B-55348
Disco de diamante Electrodepositado 16" Multi P/Rescate	1	B-66955

• Disco de carburo de tungsteno para esmeriles

Fabricado con grano de carburo de tungsteno para alta velocidad de corte

Soldadura láser para una vida más larga



Ideal para cortar panel de yeso, PVC, fibra de vidrio, epóxicos, FRP (Plástico reforzado con fibra)

PRECAUCIÓN: NO CORTAR MADERA puede atascarse y producir retroceso.

	Descripción	Diámetro	Diámetro interior	Grosor del Segmento	Uso	Materiales a Trabajar	No. Parte
	Grano carburo de tungsteno	4-1/2"	22.23mm		Seco	Placa de yeso, PVC, material FRP	B-57716
	Grano carburo de tungsteno	5"	22.23mm		Seco	Placa de yeso, PVC, material FRP	B-57722

Accesorios para DMC300

Disco de diamante, Disco abrasivo
Hoja de sierra de carburo de Tungsteno

NUEVO

ideal para Trabajos de metal,
constructores, fontaneros, decoradores
de interiores, usuarios de bricolaje



*Imágenes ilustrativas

Descripción	Diámetro Externo	Diámetro Interior	Grosor del Segmento	Tipo	Materiales a Trabajar	Piezas por empaque	No. Parte
Disco de diamante rin continuo	3" (76mm)	3/8" (9.5mm)	1.6	Borde	Azulejo	1	D-75580
Set de discos abrasivos	3" (76mm)	3/8" (9.5mm)	1.0	Plano	Acero inoxidable, Metal	5	D-75661-5
Disco de carburo de tungsteno	3" (76mm)	3/8" (9.5mm)			Panel de yeso	1	D-75596

Brocas de diamante para porcelanato Zanco Hex

NUEVO

Fabricadas con
DIAMANTE SINTETIZADO
prolongando su vida útil



Extracción de polvo angular que
permite la fácil expulsión de material

Ideales para perforaciones
en cerámica hasta clase 5,
porcelana, mármol y granito

Descripción	Medida	Empaque Piezas	No. Parte
Broca de diamante para porcelanato	1/4"	1	E-11695
Broca de diamante para porcelanato	5/16"	1	E-11704
Broca de diamante para porcelanato	3/8"	1	E-11710
Broca de diamante para porcelanato	1/2"	1	E-11726
Broca de diamante para porcelanato	3/4"	1	E-11732
Broca de diamante para porcelanato	1"	1	E-11748
Piedra limpiadora de brocas de diamante sintetizado		1	E-11754

Piedra limpiadora

Para brocas de diamante sintetizado
No. parte: E-11754

Restaura los bordes desafilados
extendiendo la duración de
la broca de diamante



Usar despues de algunas
perforaciones o cuando el
diamante se tape o pierda filo



Disco pulidor diamantado de 100mm

(Respaldo de velcro)

Para modelo:
PW5000C, PW5001C



Color	Arena	No. Parte
Azul	50	D-15584
Amarillo	100	D-15590
Naranja	200	D-15609
Rojo	400	D-15615
Verde oscuro	800	D-15621
Verde claro	1500	D-15637
Café	3000	D-15643
Verde	Pulir (acabado)	D-15659

Base metálica inclinada

Usar en	Tipo	No. Parte
4100NH2R	Base metálica inclinada tipo rodillo	143600-4
4100NH2W	Base metálica inclinada trabajo en húmedo	143602-0

Brocas de diamante electrodepositado

Para porcelanato

Ideales para perforar desde azulejo hasta porcelanato

Lubricado con aceite



Perforación sin percusión

Diámetro	No. Parte
6mm (1/4")	B-51823
8mm (5/16")	B-51839
10mm (3/8")	B-51845

Ver video



Brocasieras de diamante electrodepositado Para mármol



Ver video



Perforación sobre placas de mármol para usar con esmeril angular de 4-1/2", 7", 9"
Material: mármol

Diámetro	Rosca de la cabeza	No. Parte
1/2"	5/8"-11	*D-37758
1-1/4"	5/8"-11	*D-36332
1-3/8"	5/8"-11	*D-36348
2"	5/8"-11	*D-37764

Barrenos en concreto para toma de muestras de fraguado

Coronas de diamante para concreto
brocas saca corazones



Diámetro (mm)	Longitud total	Empaque piezas	No. Parte
29	250	1	A-11645
40	250	1	A-11667
52	250	1	A-11673
65	250	1	A-11689
75	250	1	A-11704
80	250	1	A-11710
90	250	1	A-11726
115	250	1	A-11748
120	250	1	A-11760
Extensión p/ Coronas	200	1	A-11807

Reductores

Medidas	Empaque piezas	No. Parte
25.4mm-22.23mm (espesor:1.6mm)	1	D-50871
25.4mm-22.23mm (espesor:1.8mm)	1	D-50887



Accesorios para cortadora de mármol

Mangueras de alimentación



Aplicación	Diámetro	Longitud Total	Empaque piezas	No. Parte
Manguera transparente para alimentación de agua cortadoras 4100NHH/ NSX,MT410	5mm. Int. X 7mm. Ext.	5 metros	1	412010-9
Manguera transparente para alimentación de agua cortadoras 4100NHH/ NSX,MT410	5mm. Int. X 9mm. Ext.	5 metros	1	412028-0
Manguera transparente para alimentación de agua cortadoras 4100NHH/ NSX,MT410	5mm. Int. X 7mm. Ext.	5 metros	1	412088-2
Suministro de agua p/ 4100NHH 4100NS	-	-	1	158835-4

Accesorios para tronzadora de concreto

Usar en	Descripción	Empaque Piezas	No. Parte
DPC7331	Carrito de transporte para tronzadora de concreto de 2 tiempos	1	394369600
EK7651H	Carrito de transporte para tronzadora de concreto de 4 tiempos	1	394369610



Dispositivos de refrigeración

Descripción	Empaque piezas	No. Parte
Depósito de agua con colector p/ 4190D, 5090D	1	122387-1
Depósito de agua con colector p/ 4190D, 5090D	1	134152-6
Conector de suministro p/ MT410, MCC400	1	418558-9



CARRETES DE ALAMBRE

Carrete de alambre de 0.8mm (GA 21) especial para modelo DTR180

Carrete de alambre con cubierta de polimero
No. de parte: 191J59-9

Caja con 50 piezas
 1 carrete = 120 amarres aprox.

Cubierta de polimero: Ayuda a amarrar varilla cubierta con epoxi



Carrete de alambre electro galvanizado
No. de parte: 191A57-9

Caja con 50 piezas
 1 carrete = 120 amarres aprox.

Electro galvanizado: Recubrimiento de zinc que proporciona mayor resistencia a la corrosión



No. de parte: 191L22-4

Caja con 50 piezas
 1 carrete = 120 amarres aprox.



Carrete de alambre fácil de reemplazar

1

Empuje la palanca de liberación



2

Ponga un carrete y pase el alambre por el conducto hasta que se asome por la parte frontal



3

Suelte la palanca de bloqueo



Combinaciones de amarre

Varilla aplicable: 10x10mm - 13x13mm - 16x16mm

(# significa longitud de perímetro: mm)

	Capacidad de atado (2pzas. de varilla)		
	10mm (#3)	13mm (#4)	16mm (#5)
10mm (#3)	✓	✓	✓
13mm (#4)	✓	✓	✓
16mm (#5)	✓	✓	✓

	Capacidad de atado (3pzas. de varilla)	
	10mm (#3) X 10mm (#3)	13mm (#4) X 13mm (#4)
10mm (#3)	✓	✓
13mm (#4)	✓	✓
16mm (#5)	✓	—

	Capacidad de atado (4pzas. de varilla)	
	10mm (#3) X 10mm (#3)	13mm (#4) X 13mm (#4)
10mm (#3) X 10mm (#3)	✓	✓
13mm (#4) X 13mm (#4)	✓	✓

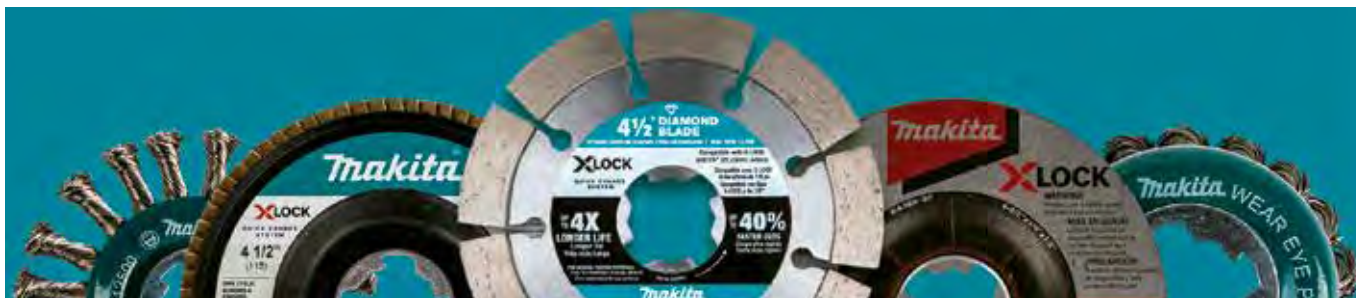

INNOVACION NUEVA

X-LOCK

SISTEMA DE CAMBIO



CAMBIOS DE ACCESORIO HASTA

5X MÁS RÁPIDOS



CAMBIO RÁPIDO

Ayuda a realizar el cambio de accesorios fácil y hasta 5 veces más rápido que el montaje de contratuerca tradicional



SISTEMA SIN HERRAMIENTAS

Montaje de click fácil y palanca de liberación para cambios de accesorios sin herramienta



COMPATIBLE CON VERSIONES ANTERIORES

La mayoría de los discos X-LOCK son compatibles con ejes de 7/8" estándar

CÓMO REALIZAR EL CAMBIO DE ACCESORIO



PRE- INSTALACIÓN

Jale la palanca hasta atrás para liberar



MONTAJE DE CLIC

Empuje el disco para conectar



LIBERACIÓN RÁPIDA

Jale la palanca para liberar el disco

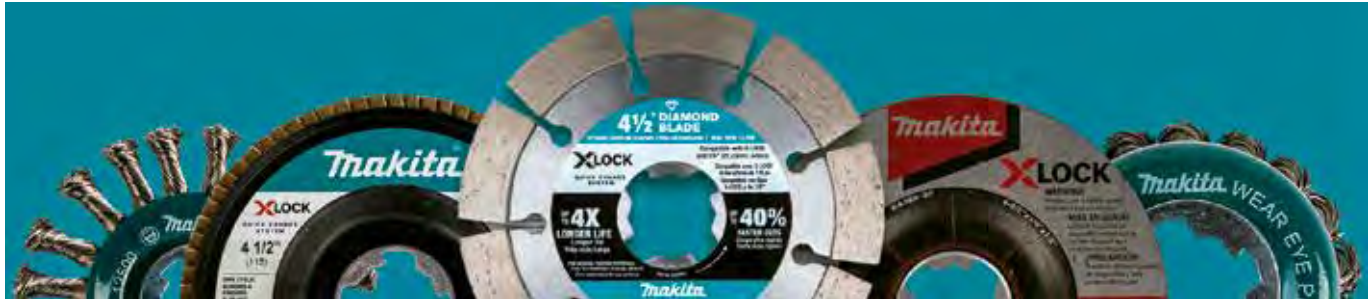

CAMBIOS DE ACCESORIO HASTA

5X MÁS RÁPIDOS

CARDAS

NUEVO

INNOVACIÓN

Sistema X-Lock de cambio rápido que brinda cambios hasta 5X más rápidos vs. montaje estándar en esmeriladoras angulares

No. Parte: D-72621

Carda tipo copa X-LOCK 3-1/8"

Alambe trenzado de acero al carbón.

Construcción de nudos resistentes para carga de trabajo pesada y eliminación de material más agresiva y eficiente

Grosor de alambre de acero al carbon de 0.020"

Ideal para operaciones reducidas, esquinas y soldaduras angulares.



No. Parte: D-72637

Carda tipo copa X-LOCK 3"

Alambe ondulado.

Construcción de alambre ondulado para cargas de trabajo ligeras y acción de cepillado menos agresiva

Grosor de alambre de acero de carbono de 0.012"

Excelente para orillas, escamas de pintura y eliminación ligera de óxido en superficies planas o irregulares.



No. Parte: D-72671

Carda tipo copa X-LOCK 3"

Alambe ondulado trenzado de acero al carbón con cubierta de latón resistente al óxido.

Construcción de alambre corrugado para carga de trabajo ligera y una acción de cepillado menos agresiva

Excelente para orillas, escamas de pintura y eliminación ligera de óxido en superficies planas o irregulares



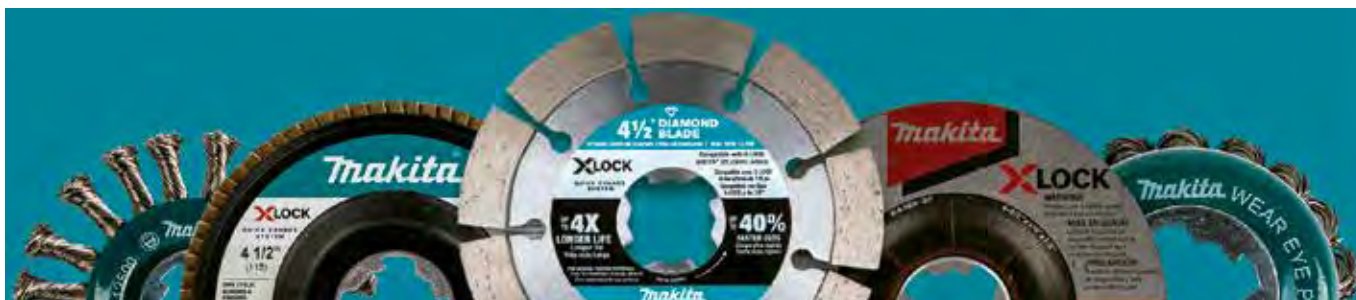

CAMBIOS DE ACCESORIO HASTA

5X MÁS RÁPIDOS

DISCOS DE DIAMÁNTE

NUEVO

INNOVACIÓN

Sistema X-Lock de cambio rápido que brinda cambios de hoja hasta 5X más rápidos vs. montaje estándar

No. Parte: E-07216

Hoja de diamante X-LOCK 4-1/2" Turbo

Hasta 4x Más duración que las hojas de la competencia

Segmentos 50% más altos que proporcionan una experiencia de corte más rápida y lisa

Disco TURBO que brinda cortes más rápidos

Ideal para cortes más agresivos en materiales de mampostería



No. Parte: E-07191

Hoja de diamante X-LOCK 4-1/2" Segmentado

Hasta 4x Más duración que las hojas de la competencia

Segmentos 50% más altos que proporcionan una experiencia de corte más rápida y lisa

Disco SEGMENTADO que brinda cortes más rápidos y más agresivos en materiales de mampostería



No. Parte: E-07397

Hoja de diamante X-LOCK 4-1/2" Segmentado

Hasta 4x Más duración que las hojas de la competencia

Segmentos 50% más altos que proporcionan una experiencia de corte más rápida, duradera y lisa

Disco de RIN CONTINUO que brinda cortes más lisos, finos y más precisos en materiales duros

Ideal para corte de cerámica y granito.



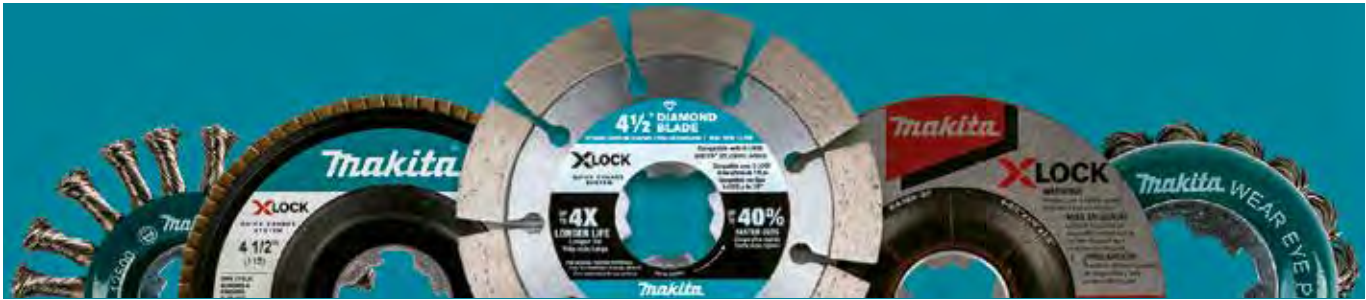

CAMBIOS DE ACCESORIO HASTA
5X MÁS RÁPIDOS

DISCOS ABRASIVOS

NUEVO

INNOVACIÓN

Sistema X-Lock de cambio rápido que brinda cambios de disco hasta 5X más rápidos vs. montaje estándar

No. Parte: E-00424

Disco abrasivo para metal X-LOCK 4-1/2" x 1/4" x 7/8"

Multiusos, grano 36, tipo 27

Construcción de óxido de aluminio con unión resinoide para eliminación de material más rápida y duración más larga
Diseño de centro hundido para un esmerilado agresivo.



No. Parte: E-00430

Disco abrasivo X-LOCK 4-1/2" x 1/4" x 7/8", para metal e Inox, grano 36

Construcción de óxido de aluminio blanco premium de alta pureza para rendimiento superior y larga duración
Diseño de centro hundido para un esmerilado agresivo
Para usar en metales ferrosos.



No. Parte: E-00446

Disco abrasivo delgado para corte, X-LOCK 4-1/2" x 0.045" x 7/8", Tipo 1 para corte de metal e Inox, grano 60

Diseño delgado de 0.045" para cortes más rápidos y menos desperdicio de material
Construcción de óxido de aluminio reforzado con unión resinoide para cortes más rápidos y larga duración.





FRESAS PARA ROUTER

Pinza sujetadora para tabla yeso

A: pedazo de diamante

Para modelo: 3706



Porte	Tipo	Parte No.
3.18mm(1/8")	-	733240-2

Depósito de guía



Modelo No.	Parte No.
3612BR	122256-6
RP1800/F, RP1801/F, RP2300FC, RP2301FC	122700-3

Adaptador para guía copiadora 30

(Plantillas para B y D, cable de dos piezas)

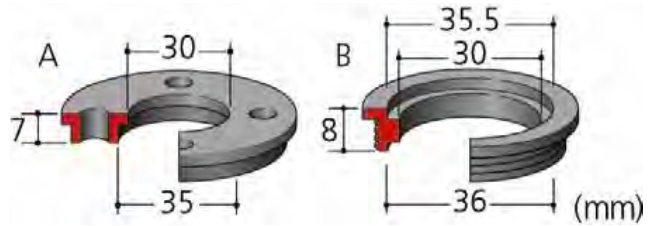

Tuerca M30, No. Parte 252627-4

Plantilla adaptador 30, tipo A o tipo B

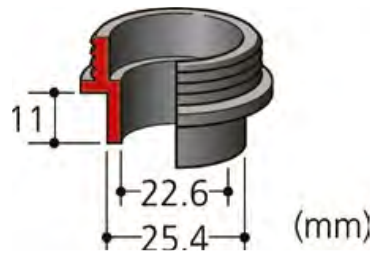

* Usar con el conjunto de base de ensamblaje

Modelo No.	Tipo	Parte No.
3612BR, RP0900, RP1800/F, RP1801/F, RP2300FC, RP2301FC, *RT0700C	A	321492-3



Guía copiadora



Para modelo:

3612BR, RP0900, RP1800/F, RP1801/F, RP2300FC, RP2301FC, *RT0700C

*Usar con el conjunto de base de ensamblaje

	A(mm)	B(mm)	C(mm)	Tipo	No. Parte
	7.7	9.5	11.5	-	164379-4
	9	11	13	-	164775-6
	11	12.7	13	-	164776-4
	14.5	16	13	-	344364-5
	18	20	13	-	164393-0
	24	27	13	-	164470-8

Para modelo: 3600H, 3601B

	A(mm)	B(mm)	C(mm)	Tipo	No. Parte
	11.1	12.7	14.3	-	321472-9
	14	16	8	-	323018-7
	14	16	14.5	-	321308-2

Para modelo: RF1100, RF1101, RD1100, RD1101, RP1100, RP1101

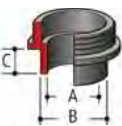
	A(mm)	B(mm)	C(mm)	Tipo	No. Parte
	57/64"	1"	7/16"	A	193235-1
	21/32"	3/4"	9/16"	A	193261-0
	11/32"	7/16"	5/32"	A	193262-8
	13/32"	1/2"	5/16"	A	193263-6
	9/32"	3/8"	5/16"	A	193264-4
	5/8"	54/64"	9/16"	A	193265-2
	17/32"	5/8"	9/16"	A	193266-0
	17/32"	5/8"	7/32"	A	193366-6

Guía de corte al hilo

Usar con el conjunto de base de ensamblaje



Modelo No.	No. Parte
3600H, 3601B	122343-1
3612BR, RP1800/F, RP1801/F, RP2300FC, RP2301FC	123022-4
RP0900, *RT0700C	STEX122385

Guía recta

A: Guía recta con micro ajuste



* Usar con el conjunto de base de ensamblaje

Modelo No.	Tipo	Material	No. Parte
3600H, 3601B	-		123029-0
3612BR	-		342428-9
RP0900, RP0910, RP1110C	-		164834-6
RF1100, RF1101, RD1100, RD1101, RP1100, RP1101	-		193073-1

Guía recta

Modelo No.	Tipo	No. Parte
3706	B	123058-3



Guía circular

Modelo No.	Tipo	No. Parte
3706	B	193448-4



Guía paralela

Modelo No.	No. Parte
3612/C, RP1800, RP3200FC	194935-6



Guía copiadora

Para modelo:
3707/F/FC, 3708/F/FC
3709, 3710, N3701, RT0700C



(Use plantillas para una producción más rápida de formas complejas)

A(mm)	B(mm)	C(mm)	Tipo	Parte No.
8	10	9.5	-	343577-5

Collets y tuercas de sujeción



Usar en	Descripción	Medida	No. Parte
GD0800C, GD0810C	Collet con tuerca	1/8"	192987-1
RF1100, RF1101, RD1100, RD1101, RP1100, RP1101	Collet con tuerca	1/4"	193214-9
RF1100	Collet con tuerca	1/2"	193215-7
3606	Collet	3mm	763610-1
903	Collet	1/4"	763608-8
906/H, GD0600, GD0601	Collet	6mm	763620-8
3601B, 3620, RP0900, RT0700C	Casquillo	1/4"	763637-1
3709, 3710	Collet	1/4"	763663-0
RP1101, RD1101, RF1101, RP1101	Collet	1/2"	763643-6
3600H, 3612BR, RP1800/F, RP1801/F, RP2300FC, RP2301FC	Collet	1/2"	763622-4
3601B, 3620	Tuerca de sujeción	1/2"	763623-2
GE0600	Tuerca de sujeción	1/4"	763625-8
906H	Tuerca de sujeción	1/8"	763626-6
903	Tuerca de sujeción	3mm.	763609-6
3709, 3707	Tuerca de sujeción	6.5mm.	763661-4
GD0600	Tuerca de sujeción	6mm.	763664-8
3706, 3707	Tuerca de sujeción	8mm.	763606-2
GD0800C, GD0810C	Tuerca de sujeción	10mm.	763645-2
RP1801, RP2301, 3612	Tuerca de sujeción	1/2"	763629-0
RF1100	Tuerca de sujeción	1/2"	763642-8
GD0602, BGD800	Tuerca de sujeción	1/4"	763668-0
RP2300, RP1800	Tuerca de sujeción	1/2", 1/4"	763674-5
3600H, 3601B, 3612BR, RP1800/F, RP1801/F, RP2300FC, RP2301FC	Buje reductor	1/2", 3/8"	763805-6
GD0800	Collet	1/4"	193143-6
3601B, RD1101, RF1101, RP1800, RP2301FC	Collet	1/4"	763803-0

Otros



Usar en	Descripción	Empaque Piezas	No. Parte
3706	Depósito de la llave	1	423319-4

Bases para routers



Usar en	Descripción	Empaque piezas	No. Parte
3606, 3612, 3621	Cabezal para aspiradora	1	192035-6
RD1101	Boquilla para bolsa de polvo	1	193379-7
RD1100	Base estándar	1	193103-8
RD1101	Base de mango, base con empuñadura	1	193104-6
RP1101	Sub base (acrílico)	1	193155-9
RT0700CX2 / DRT50	Base recortadora de inmersión	1	196094-2
RT0700CX2 / DRT50	Base recortadora inclinable	1	196092-6
RT0700CX2 / DRT50	Base recortadora de inmersión	1	196093-4
RT0700CX2 / DRT50	Base recortadora	1	142403-3 

Base transparente

- A: Base transparente
- B: Para biselado
- C: Para un ajuste profundo



Modelo No.	Tipo	No. Parte
3700B, N3701, 3703, 3704	B	STEX122390
DRT50	A	199090-9

Galletas para ensamble



Usar en	Aplicación	Medidas	Empaque Piezas	No. Parte
Engalletadoras mod. 3901, PJ7000, LXPJ02	Ensamble de piezas de madera	# 0 48x16x4mm	Bolsa 1000 pzs.	P-08838
Engalletadoras mod. 3901, PJ7000, LXPJ02	Ensamble de piezas de madera	# 10 50x20x4mm	Bolsa 1000 pzs.	P-08844
Engalletadoras mod. 3901, PJ7000, LXPJ02	Ensamble de piezas de madera	# 20 55x25x4mm	Bolsa 1000 pzs.	P-08850

Disco para engalletadora

Ranurado de piezas de madera para ensamble



Diámetro	Dientes	Descripción	Empaque Piezas	No. Parte
4x7/8"	6	Disco de sierra para engalletadora	1	A-95118

Complementos



Descripción	Aplicación	Empaque Piezas	No. Parte
Empuñadura superior para 3901	Mejor control y apoyo	1	415253-2
Guía regla	Ajuste para cortes exactos	1	122473-8
Empuñadura para PJ700	Mejor control y apoyo	1	453218-6
Guía completa para PJ700	Ajuste para cortes exactos	1	141247-8

Fresas para router "estándar"

Fresa recta 1 filo

NUEVO



Zanco	Diámetro	Longitud	Altura de cabeza	Ángulo	Filos	Empaque Piezas	No. Parte
1/4"	1/8"	2"	1/2"		1	1	D-68862
1/4"	5/32"	2"	1/2"		1	1	D-68878
1/4"	3-16"	1-7/8"	1/2"		1	1	D-68884
1/4"	1/4"	2"	3/4"		1	1	D-68890
1/2"	1/4"	2-1/2"	3/4"		1	1	D-68909
1/2"	3/8"	2-1/2"	1"		1	1	D-68915

Fresas recta 2 filos

NUEVO



Zanco	Diámetro	Longitud	Altura de cabeza	Ángulo	Filos	Empaque Piezas	No. Parte
1/4"	1/4"	2"	1"		2	1	D-68921
1/4"	5/16"	1-7/8"	1"		2	1	D-68937
1/4"	3-8"	2-1/2"	1"		2	1	D-68943
1/4"	1/2"	2-1/4"	1-1/4"		2	1	D-68959
1/4"	1/4"	2-1/4"	5/8"		2	1	D-68965
1/4"	1/4"	2-1/4"	3/4"		2	1	D-68971

Fresas recta 2 filos

NUEVO



Zanco	Diámetro	Longitud	Altura de cabeza	Ángulo	Filos	Empaque Piezas	No. Parte
1/4"	5/16"	2"	3/4"		2	1	D-68987
1/4"	3/8"	2"	3/4"		2	1	D-68993
1/4"	1/2"	2"	3/4"		2	1	D-69004
1/4"	9/16"	2"	3/4"		2	1	D-69010
1/4"	5/8"	2"	3/4"		2	1	D-69026
1/4"	23/32"	2"	3/4"		2	1	D-69032
1/4"	3/4"	2"	3/4"		2	1	D-69048
1/2"	1/4"	2-1/2"	3/4"		2	1	D-69054
1/2"	5/16"	2-3/4"	1"		2	1	D-69060
1/2"	3/8"	2-7/8"	1"		2	1	D-69076
1/2"	1/2"	2-5/8"	1"		2	1	D-69082
1/2"	1/2"	2-7/8"	1-1/4"		2	1	D-69098
1/2"	1/2"	3"	1-1/2"		2	1	D-69107
1/2"	9/16"	2-7/8"	1-1/4"		2	1	D-69113
1/2"	5/8"	2-7/8"	1-1/4"		2	1	D-69129
1/2"	3/4"	2-5/8"	1"		2	1	D-69135
1/2"	3/4"	2-7/8"	1-1/4"		2	1	D-69141
1/2"	3/4"	3"	1-1/2"		2	1	D-69157
1/2"	7/8"	2-5/8"	1"		2	1	D-69163
1/2"	7/8"	2-7/8"	1-1/4"		2	1	D-69179
1/2"	1"	2-7/8"	1-1/4"		2	1	D-69185
1/2"	1/2"	4-1/2"	2-1/2"		2	1	D-69191
1/2"	1/2"	4"	2"		2	1	D-69200

Fresas para enrasar C/balero arriba

NUEVO



Zanco	Diámetro	Longitud	Altura de cabeza	Ángulo	Filos	Empaque Piezas	No. Parte
1/2"	3/4"	2-13/16"	1"		2	1	D-69216

Fresas para bisagra

NUEVO



Zanco	Diámetro	Longitud	Altura de cabeza	Ángulo	Filos	Empaque Piezas	No. Parte
1/4"	1/2"	2"	3/4"		2	1	D-69222

Fresas para enrasar con balero 2 filos

NUEVO



Zanco	Diámetro	Longitud	Altura de cabeza	Ángulo	Filos	Empaque Piezas	No. Parte
1/4"	3/8"	2-5/8"	1"		2	1	D-69238
1/4"	1/2"	2-3/16"	1/2"		2	1	D-69244
1/4"	1/2"	2-11/16"	1"		2	1	D-69250
1/4"	1/4"	2-1/8"	1/2"		2	1	D-69266
1/4"	3/8"	2-1/8"	1/2"		2	1	D-69272
1/2"	1/2"	3"	1"		2	1	D-69288
1/2"	1/2"	3-19/32"	1-1/2"		2	1	D-69294
1/2"	1/2"	4-1/64"	2"		2	1	D-69303
1/2"	3/4"	3-9/32"	1"		2	1	D-69319
1/2"	3/4"	3-5/16"	1-1/4"		2	1	D-69325

Fresas para enrasar con balero 3 filos

NUEVO



Zanco	Diámetro	Longitud	Altura de cabeza	Ángulo	Filos	Empaque Piezas	No. Parte
1/4"	1/2"	2-11/16"	1"		3	1	D-69331
1/2"	1/2"	3-19/32"	1-1/2"		3	1	D-69347

Fresas para enrasar con balero alto

NUEVO



Zanco	Diámetro	Longitud	Altura de cabeza	Ángulo	Filos	Empaque Piezas	No. Parte
1/4"	1/2"	1-7/8"	1/4"		2	1	D-69353
1/4"	1/2"	2-5/8"	1"		2	1	D-69369

Fresas piloto para panel

NUEVO



Zanco	Diámetro	Longitud	Altura de cabeza	Ángulo	Filos	Empaque Piezas	No. Parte
1/4"	1/4"	2-9/16"	3/4"		1	1	D-69375
1/2"	3/8"	3"	1"		1	1	D-69381

Fresas tipo "U"

NUEVO



Zanco	Diámetro	Longitud	Altura de cabeza	Ángulo	Filos	Empaque Piezas	No. Parte
1/4"	1/2"	2"	3/4"		2	1	D-69397
1/4"	1/4"	1-3/4"	1/2"		2	1	D-69406
1/4"	3/8"	1-3/4"	1/2"		2	1	D-69412
1/2"	3/8"	2-1/4"	1/2"		2	1	D-69428
1/2"	1/2"	2-3/8"	3/4"		2	1	D-69434
1/2"	3/4"	2-5/8"	1"		2	1	D-69440

Fresas en "V"

NUEVO



Zanco	Diámetro	Longitud	Altura de cabeza	Ángulo	Filos	Empaque Piezas	No. Parte
1/4"	1/2"	1-7/8"	5/8"	60°	2	1	D-69456
1/4"	3/4"	1-7/8"	5/8"	90°	2	1	D-69462
1/4"	1/2"	1-3/4"	1/2"	90°	2	1	D-69478
1/4"	5/8"	1-3/4"	1/2"	90°	2	1	D-69484
1/2"	1/2"	2-1/8"	1/2"	90°	2	1	D-69490
1/2"	5/8"	2"	1/2"	90°	2	1	D-69509
1/2"	7/8"	2-1/4"	5/8"	90°	2	1	D-69515
1/2"	3/4"	2-1/4"	5/8"	90°	2	1	D-69521
1/2"	1-1/8"	2-3/8"	7/8"	90°	2	1	D-69537

Fresas tipo "U"

NUEVO



Zanco	Diámetro	Longitud	Altura de cabeza	Ángulo	Filos	Empaque Piezas	No. Parte
1/4"	1/4"	1-1/2"	1/4"		2	1	D-69543
1/4"	5/16"	1-37/64"	5/16"		2	1	D-69559
1/4"	3/8"	1-5/8"	3/8"		2	1	D-69565
1/4"	1/2"	1-5/8"	3/8"		2	1	D-69571
1/4"	5/8"	1-3/4"	1/2"		2	1	D-69587
1/2"	3/4"	2"	1/2"		2	1	D-69593
1/2"	1"	2-1/4"	5/8"		2	1	D-69602
1/2"	1-1/4"	2-3/8"	3/4"		2	1	D-69618

Fresas cola de milano

NUEVO



Zanco	Diámetro	Longitud	Altura de cabeza	Ángulo	Filos	Empaque Piezas	No. Parte
1/4"	1/4"	2-1/8"	5/16"	7.5°	2	1	D-69624
1/4"	3/8"	1-9/16"	3/8"	9°	2	1	D-69630
1/4"	1/2"	1-7/8"	1/2"	14°	2	1	D-69646
1/2"	3/8"	2-1/8"	3/8"	9°	2	1	D-69652

Fresas para ranurar clasica

NUEVO



Zanco	Diámetro	Longitud	Altura de cabeza	Ángulo	Filos	Empaque Piezas	No. Parte
1/4"	3/4"	1-11/16"	7/16"		2	1	D-69727

Fresas para ranurar tipo bola

NUEVO



Zanco	Diámetro	Longitud	Altura de cabeza	Ángulo	Filos	Empaque Piezas	No. Parte
1/4"	1/2"	1-3/4"	29/64"		2	1	D-69668

Fresas ovovalo

NUEVO



Zanco	Diámetro	Longitud	Altura de cabeza	Ángulo	Filos	Empaque Piezas	No. Parte
1/4"	3/4"	1-11/16"	3/8"		2	1	D-69733

Fresas para redondear

NUEVO



Zanco	Diámetro	Longitud	Altura de cabeza	Ángulo	Filos	Empaque Piezas	No. Parte
1/4"	3/4"	1-7/8"	1/2"		2	1	D-69674
1/4"	1"	1-7/8"	5/8"		2	1	D-69680

Fresas para redondear con balero

NUEVO



Zanco	Diámetro	Longitud	Altura de cabeza	Ángulo	Filos	Empaque Piezas	No. Parte
1/4"	3/4"	2-1/8"	3/8"		2	1	D-69749
1/4"	7/8"	2-5/32"	1/2"		2	1	D-69755
1/4"	1"	2-1/4"	17/32"		2	1	D-69761
1/4"	1/2"	1-5/8"	3/8"		2	1	D-69777
1/4"	1-1/4"	2-5/16"	21/32"		2	1	D-69783
1/4"	1-1/2"	2-7/16"	3/4"		2	1	D-69799
1/2"	1-1/2"	2-11/16"	3/4"		2	1	D-69808
1/2"	2"	2-15/16"	1"		2	1	D-69814

Fresas para ranurar romana

NUEVO



Zanco	Diámetro	Longitud	Altura de cabeza	Ángulo	Filos	Empaque Piezas	No. Parte
1/4"	3/4"	1-11/16"	7/16"		2	1	D-69696

Fresas esquina redondeada

NUEVO



Zanco	Diámetro	Longitud	Altura de cabeza	Ángulo	Filos	Empaque Piezas	No. Parte
1/4"	3/4"	2-1/32"	3/8"		2	1	D-69820
1/4"	7/8"	2-1/8"	1/2"		2	1	D-69836
1/4"	1"	2-5/32"	17/32"		2	1	D-69842
1/4"	1-1/4"	2-9/32"	21/32"		2	1	D-69858
1/4"	1-1/2"	2-3/8"	3/4"		2	1	D-69864

Fresas para panel tipo clasica

NUEVO



Zanco	Diámetro	Longitud	Altura de cabeza	Ángulo	Filos	Empaque Piezas	No. Parte
1/4"	1/2"	1-21/32"	3/8"		1	2	D-69705
1/2"	1"	2-1/8"	5/8"		1	2	D-69711

Fresa doble redondeo

NUEVO



Zanco	Diámetro	Longitud	Altura de cabeza	Ángulo	Filos	Empaque Piezas	No. Parte
1/4"	1-1/8"	2"	1/2"		2	1	D-69870

Fresa para perfilar con balero

NUEVO



Zanco	Diámetro	Longitud	Altura de cabeza	Ángulo	Filos	Empaque Piezas	No. Parte
1/4"	1-1/2"	2-5/16"	5/8"		2	1	D-70035

Fresa media caña con balero

NUEVO



Zanco	Diámetro	Longitud	Altura de cabeza	Ángulo	Filos	Empaque Piezas	No. Parte
1/4"	5/8"	1-15/16"	1/4"		2	1	D-69886
1/4"	3/4"	1-13/16"	3/8"		2	1	D-69892
1/4"	7/8"	2-3/16"	1/2"		2	1	D-69901
1/4"	1-1/8"	3-3/16"	1/2"		2	1	D-69917
1/4"	1-1/4"	2-13/64"	17/32"		2	1	D-69923
1/4"	1-1/2"	2-5/16"	5/8"		2	1	D-69939

Fresa multiperfil

NUEVO



Zanco	Diámetro	Longitud	Altura de cabeza	Ángulo	Filos	Empaque Piezas	No. Parte
1/2"	2-1/4"	4"	1-7/8"		2	1	D-70041

Fresa chaflan

NUEVO



Zanco	Diámetro	Longitud	Altura de cabeza	Ángulo	Filos	Empaque Piezas	No. Parte
1/4"	1"	2"	3/8"	45°	2	1	D-69945
1/4"	7/8"	2-3/16"	1/2"	25°	2	1	D-69951
1/4"	1-3/16"	2-1/8"	1/2"	45°	2	1	D-69967
1/4"	1-1/4"	2-11/64"	17-32"	45°	2	1	D-69973
1/4"	1-5/8"	2-5/16"	13/16"	45°	2	1	D-69989

Fresa reversible de carril

NUEVO



Zanco	Diámetro	Longitud	Altura de cabeza	Ángulo	Filos	Empaque Piezas	No. Parte
1/2"	1-5/8"	3-3/32"	29/32"		2	1	D-70057

Fresa para cerradura

NUEVO



Zanco	Diámetro	Longitud	Altura de cabeza	Ángulo	Filos	Empaque Piezas	No. Parte
1/4"	3/8"	1-7/8"	13/32"		2	1	D-70063

Fresa para encaje

NUEVO



Zanco	Diámetro	Longitud	Altura de cabeza	Ángulo	Filos	Empaque Piezas	No. Parte
1/4"	1-1/4"	2-1/8"	1/2"		2	1	D-69995
1/2"	1-1/4"	2-3/16"	1/2"		2	1	D-70007

Fresas reversible

NUEVO



Zanco	Diámetro	Longitud	Altura de cabeza	Ángulo	Filos	Empaque Piezas	No. Parte
1/2"	1-5/8"	3"	1"		2	1	D-70079

Fresa romana

NUEVO



Zanco	Diámetro	Longitud	Altura de cabeza	Ángulo	Filos	Empaque Piezas	No. Parte
1/4"	1-1/8"	2-11/64"	1/2"		2	1	D-70013
1/4"	1-1/2"	2-3/8"	11/16"		2	1	D-70029

Fresas ranuradora tipo lengua

NUEVO



Zanco	Diámetro	Longitud	Altura de cabeza	Ángulo	Filos	Empaque Piezas	No. Parte
1/2"	1-39/64"	2-51/64"	3/4"		4	1	D-70085

Fresa de ranurado



NUEVO

Zanco	Diámetro	Longitud	Altura de cabeza	Ángulo	Filos	Empaque Piezas	No. Parte
1/4"	1-7/8"	2-5/16"	5/64"		3	1	D-70091
1/4"	1-7/8"	2-5/16"	3/32"		3	1	D-70100
1/4"	1-7/8"	2-5/16"	1/8"		3	1	D-70116
1/4"	1-7/8"	2-5/16"	5/32"		3	1	D-70122
1/4"	1-7/8"	2-5/16"	3/16"		3	1	D-70138
1/4"	1-7/8"	2-5/16"	7/32"		3	1	D-70144

Fresas para bisagras



A	B	C	D	E	Empaque piezas	No. Parte
1/2"	3/4"	1-1/4"	1/4"	2-1/64"	1	D-01644
3/4"	3/4"	1-1/4"	1/4"	2-1/64"	1	D-01650

Fresa clasica



NUEVO

Zanco	Diámetro	Longitud	Altura de cabeza	Ángulo	Filos	Empaque Piezas	No. Parte
1/2"	1-3/8"	2-9/16"	5/8"		2	1	D-70150

Fresa recta

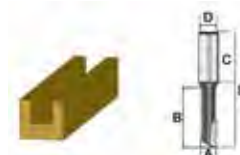

A	B	C	D	E	Empaque piezas	No. Parte
1/8"	7/16"	1-3/8"	1/4"	2-3/32"	1	D-01270
1/8"	13/64"	1-3/8"	1/4"	1-27/32"	1	D-01345
3/16"	7/16"	1-3/8"	1/4"	2"	1	D-01367
1/4"	1"	1-1/4"	1/4"	2-3/8"	1	D-01286
1/4"	3/4"	1-1/4"	1/4"	2-1/8"	1	D-01373
1/4"	1"	1-1/4"	1/4"	2-3/8"	1	D-01389
1/4"	3/4"	1-1/2"	1/2"	2-9/16"	1	D-01507
5/16"	1"	1-1/4"	1/4"	2-17/64"	1	D-01395
3/8"	1"	1-1/2"	1/2"	2-3/4"	1	D-01292
3/8"	1"	1-1/4"	1/4"	2-17/64"	1	D-01404
3/8"	1"	1-1/2"	1/2"	2-47/64"	1	D-01513
7/16"	1"	1-1/4"	1/4"	2-17/64"	1	D-01410
1/2"	1-1/4"	1-3/8"	1/2"	2-7/8"	1	D-01301
1/2"	1-1/2"	1-3/8"	1/2"	3-1/8"	1	D-01317
1/2"	2"	2-1/16"	1/2"	4-1/4"	1	D-01323
1/2"	1"	1-1/4"	1/4"	2-17/64"	1	D-01426
1/2"	1"	1-1/2"	1/2"	2-21/32"	1	D-01529
5/8"	3/4"	1-1/4"	1/4"	2-1/64"	1	D-01432
3/4"	3/4"	1-1/4"	1/4"	2-1/64"	1	D-01448
1"	1-1/4"	*	1/2"	*	1	D-01622
1-1/4"	1-1/4"	1-1/2"	1/2"	2-3/4"	1	D-01638

Fresas para router "estándar"

Cola de milano

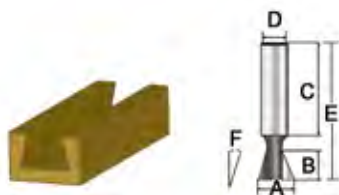

A	B	C	D	E	F	Empaque Piezas	No. Parte
3/8"	3/8"	1-1/4"	1/4"	1-3/4"	9°	1	D-01878
3/8"	3/8"	1-1/2"	1/2"	2-3/16"	9°	1	D-01884
1/2"	1/2"	1-1/4"	1/4"	1-7/8"	14°	1	D-01909
5/8"	7/8"	1-7/16"	1/2"	2-33/64"	7°	1	D-01915
1/4"	3/8"	1-61/64"	1/4"	2-1/2"	7.5°	1	D-01937
5/16"	3/8"	1-11/16"	1/4"	2-7/32"	9°	1	D-01943

Fresas para abertura de canal recto

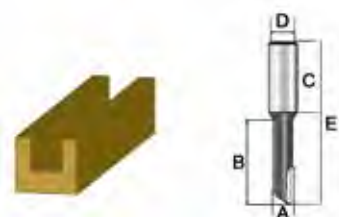

A	B	C	D	E	Empaque Piezas	No. Parte
3/8"	1-1/2"	1-1/4"	1/2"	3"	1	D-01965

Fresas tipo U



A	B	C	D	E	Empaque piezas	No. Parte
1/8"	7/32"	1-9/64"	1/4"	1-37/64"	1	D-01672
3/16"	7/32"	1-3/16"	1/4"	1-37/64"	1	D-01688

Ranuras tipo "v"

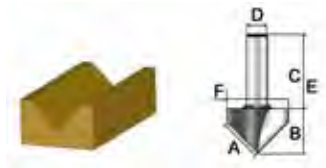

A	B	C	D	E	F	Empaque piezas	No. Parte
3/8"	7/64"	1-3/16"	1/4"	1-5/8"	3/8"	1	D-01828
5/8"	5/8"	1-1/4"	1/4"	1-57/64"	7/8"	1	D-01840

Fresas "V" media caña HT



A	B	C	D	E	Empaque piezas	No. Parte
1/2"	3/8"	1-1/2"	1/4"	1-7/8"	1	D-02107

Fresa media caña

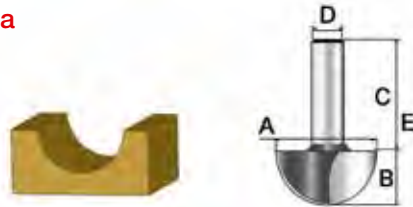

A	B	C	D	E	Empaque piezas	No. Parte
1/4"	1/4"	1-1/4"	1/4"	1-5/8"	1	D-01719
3/8"	1/4"	1-1/4"	1/4"	1-33/64"	1	D-01725
1/2"	3/8"	1-1/4"	1/4"	1-41/64"	1	D-01731
5/8"	7/16"	1-5/16"	1/4"	1-3/4"	1	D-01747
3/4"	7/16"	1-5/16"	1/4"	1-3/4"	1	D-01753
1"	11/16"	1-7/16"	1/2"	2-1/8"	1	D-01775
1-1/4"	3/4"	1-1/4"	1/2"	5/16"	1	D-01781

Fresas para cerraduras



A	B	C	D	E	Empaque piezas	No. Parte
3/8"	3/8"	1"	1/4"	1-1/2"	1	D-02129

Esquina redondeada

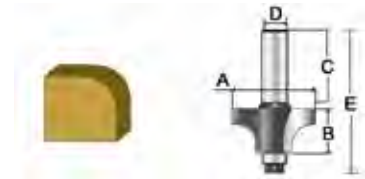

A	B	C	D	E	F	Empaque piezas	No. Parte
1/8"	3/8"	1-1/4"	1/4"	2-1/16"	3/4"	1	D-02141
3/16"	1/2"	1-1/4"	1/4"	2-3/16"	7/8"	1	D-02163
1/4"	1/2"	1-1/4"	1/4"	2-3/16"	1"	1	D-02185
1/4"	1/2"	1-1/2"	1/2"	2-7/16"	1"	1	D-02191
3/8"	5/8"	1-1/4"	1/4"	2-5/16"	1-1/4"	1	D-02216
1/2"	3/4"	1-1/2"	1/2"	2-11/16"	1-1/2"	1	D-02244
5/8"	7/8"	1-5/16"	1/2"	2-3/8"	1-3/4"	1	D-02250
3/4"	1"	1-5/16"	1/2"	2-3/8"	2"	1	D-02266

Fresas piloto HT



A	B	C	D	E	Empaque piezas	No. Parte
1/4"	3/4"	1"	1/4"	2-9/16"	1	D-01987

Fresas recta con balero superior 2 canales

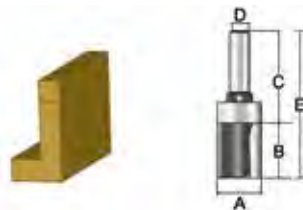

A	B	C	D	E	Empaque Piezas	No. Parte
1/2"	1"	1-1/2"	1/4"	2-1/2"	1	D-02054
3/4"	1"	1-1/2"	1/4"	2-1/2"	1	D-02076

Moldura

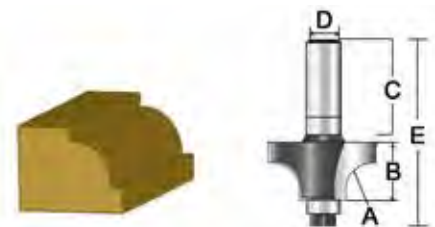

A	B	C	D	E	F	Empaque piezas	No. Parte
3/16"	1/2"	1-1/4"	1/4"	2-7/64"	7/8"	1	D-02319
1/4"	1/2"	1-1/4"	1/4"	2-7/64"	1"	1	D-02325
3/8"	5/8"	1-1/4"	1/4"	2-15/64"	1-1/4"	1	D-02347

Moldura cóncava con balero



A	B	C	D	E	F	Empaque Piezas	No. Parte
1/4"	9/16"	1-1/8"	1/4"	2"	7/8"	1	D-02397
3/8"	9/16"	1-1/8"	1/4"	2"	1-1/8"	1	D-02406
1/2"	3/4"	1-1/8"	1/4"	2-3/16"	1-3/8"	1	D-02428

Romana con balero

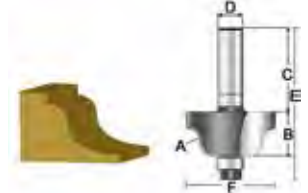

A	B	C	D	E	F	Empaque piezas	No. Parte
5/32"	5/8"	1-1/4"	1/4"	2-13/64"		1	D-02593
1/4"	7/8"	1-1/4"	1/4"	2-1/4"		1	D-02618

Multirebajador con balero

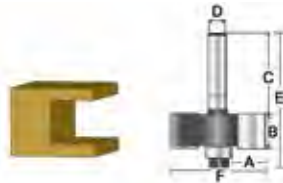

A	B	C	D	E	F	Empaque piezas	No. Parte
3/8", 1/2", 5/8", 3/4"	1/2"	1-5/16"	1/4"	2-1/4"	1-3/8"	1	D-02571

Doble romana con balero

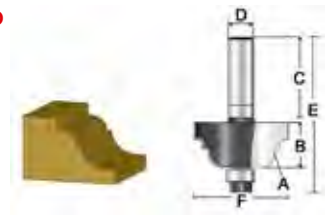

A	B	C	D	E	F	Empaque piezas	No. Parte
1/4"	3/8"	1-1/4"	1/4"	2-1/16"	3/4"	1	D-02652

Bisel 45° con balero

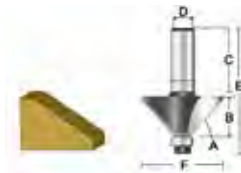

A	B	C	D	E	F	Empaque piezas	No. Parte
21/32"	1/2"	1-1/4"	1/4"	2-5/64"	45mm	1	D-02478
45/64"	47/64"	1-5/16"	1/4"	2-29/64"	15mm	1	D-02509
5/8"	1/2"	1-5/16"	1/2"	2-3/8"	45mm	1	D-02484

Borde clásico con balero

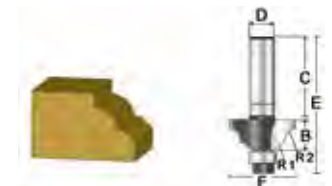

A	B	C	D	E	F	Empaque Piezas	No. Parte
3/4"	1/2"	1-1/4"	1/4"	2-3/16"	7/8"	1	D-02668

Moldura rebajada con rodamiento

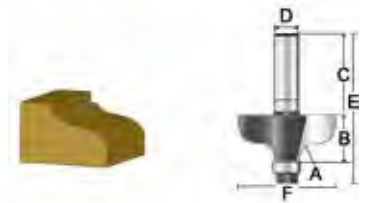

A	B	C	D	E	F	Empaque piezas	No. Parte
1/4"	1/2"	1-1/4"	1/4"	2-3/16"	1"	1	D-02680

Ranuradora 3 filas

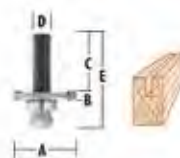

A	B	C	D	E	F	Empaque piezas	No. Parte
1-7/8"	5/32"	1-1/4"	1/4"	2-1/8"		1	D-02967

Rebajadora con balero



A	B	C	D	E	F	Empaque piezas	No. Parte
3/8"	1/2"	1-1/4"	1/4"	2-5/32"	1-1/4"	1	D-02537

Moldura cóncava y convexa con balero



A	B	C	D	E	F	Empaque Piezas	No. Parte
1/8"	9/16"	1"	1/4"	2-1/8"	7/8"	1	D-02711

Fresa doble para moldura tipo guarnición

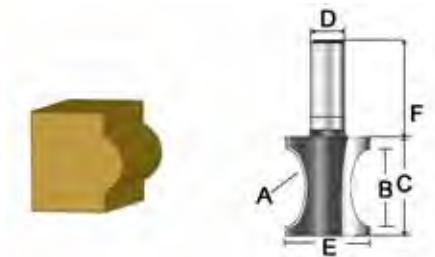

A	B	C	D	E	F	Empaque piezas	No. Parte
23/32"	27/32"	1-1/4"	1/4"	13/16"	2-1/2"	1	D-02749

Fresa combinada 23

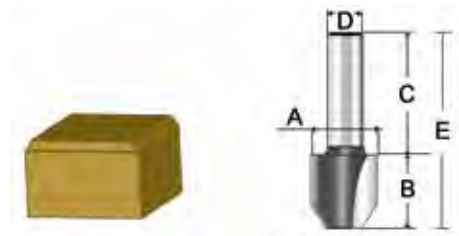

A	B	C	D	E	Empaque piezas	No. Parte
7/16"	1/2"	1-1/4"	1/4"	1-3/4"	1	D-03187

Fresas para rebaje 7



A	B	C	D	E	Empaque piezas	No. Parte
3/16"	1/4"	1-1/16"	1/4"	1-1/2"	1	D-03062

Fresa tipo rebaje en formaica con balero



A	B	C	D	E	Empaque piezas	No. Parte
1/2"	1"	1"	1/4"	2-5/8"	1	D-03193

Fresa doble para rebaje en formaica con balero

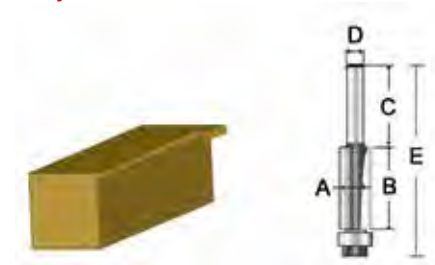

A	B	C	D	E	Empaque piezas	No. Parte
3/8"	1/2"	1"	1/4"	2-1/8"	1	D-03084
3/8"	1"	1-1/4"	1/4"	2-5/8"	1	D-03090
1/2"	1/2"	1-1/4"	1/4"	2-1/4"	1	D-03109
1/2"	1"	1-1/4"	1/4"	2-5/8"	1	D-03115
1/2"	1-1/2"	1-1/2"	1/2"	3-7/8"	1	D-03137

Fresa doble para rebaje 15 con balero

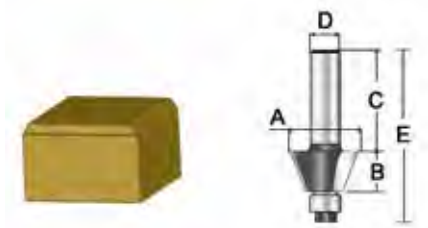

A	B	C	D	E	Empaque piezas	No. Parte
1/2"	9/32"	1"	1/4"	1-7/8"	1	D-03230

Fresa combinada 10



A	B	C	D	E	Empaque piezas	No. Parte
1/4"	3/8"	1"	1/4"	1-1/2"	1	D-03171

Fresa doble para rebaje 25 con balero



A	B	C	D	E	Empaque piezas	No. Parte
1/2"	9/32"	1"	1/4"	1-7/8"	1	D-03246
*	*	*	1/2"	*	1	D-03143

Fresa doble para rebaje 25 con balero 4 hojas

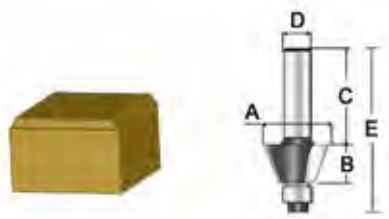

A	B	C	D	E	Empaque piezas	No. Parte
5/8"	3/8"	1-1/4"	1/4"	2-3/8"	1	D-03252

Fresa para enrasar CT



A	B	C	Filos	Adicional	Empaque piezas	No. Parte
3/8"	1"	1/4"	2	Larga con balero	1	D-49264
1/2"	1/2"	1/4"	2	con balero	1	D-49270
1/2"	1"	1/4"	2	Larga con balero	1	D-49286
1/2"	1"	1/4"	3	con balero	1	D-49292
1/2"	1-1/2"	1/2"	3	con balero	1	D-49301

Fresa para router



Fresa recta CT



Fresa para enrasar formaica



A	B	C	Filos	Adicional	Empaque piezas	No. Parte
1/4"	1/2"	1/4"	2	con balero	1	D-58528
3/8"	1/2"	1/4"	2	con balero	1	D-58534
1/2"	1"	1/2"	2	con balero	1	D-58540

A	B	C	Filos	Adicional	Empaque piezas	No. Parte
1/8"	1/2"	1/4"	1		1	D-49002
1/4"	3/4"	1/4"	1		1	D-49030
1/4"	1"	1/4"	2		1	D-49052
5/16"	1"	1/4"	2		1	D-49068
3/8"	1"	1/4"	2		1	D-49074
1/2"	1-1/4"	1/4"	2		1	D-49080
1/4"	3/4"	1/4"	2		1	D-49105
5/16"	3/4"	1/4"	2		1	D-49111
3/8"	3/4"	1/4"	2		1	D-49127
1/2"	3/4"	1/4"	2		1	D-49133
1/2"	2-1/2"	1/2"	2		1	D-58512
5/8"	3/4"	1/4"	2		1	D-49155
3/4"	3/4"	1/4"	2		1	D-49177
3/8"	1"	1/2"	2		1	D-49199
1/2"	1-1/4"	1/2"	2		1	D-49208
9/16"	1-1/4"	1/2"	2		1	D-49214
5/8"	1-1/4"	1/2"	2		1	D-49220
3/4"	1-1/4"	1/2"	2		1	D-49236
7/8"	1-1/4"	1/2"	2		1	D-49242
1"	1-1/4"	1/2"	2		1	D-49258

Fresa piloto CT



A	B	C	Filos	Adicional	Empaque Piezas	No. Parte
1/4"	3/4"	1/4"	1	Fresa para copiar	1	D-49317
3/8"	1"	1/2"	1	Fresa para copiar	1	D-49323
1/2"	1-17/64"	1/2"	1	Cortar y perfilar	1	D-58556
1/2"	3/4"	1/4"	2	Mortajar p/ bisagra	1	D-58562

Fresa para ranurar CT



A	B	C	Filos	Diámetro	Adicional	No. Parte
1/4"	1/4"	1/4"	2	1/8"	Fresa para ranurar	D-49448
3/8"	3/8"	1/4"	2	3/16"	Fresa para ranurar	D-49460
1/2"	3/8"	1/4"	2	1/4"	Fresa para ranurar	D-49476
5/8"	1/2"	1/4"	2	5/16"	Fresa para ranurar	D-49482

Fresa cola de milano CT



A	B	C	Filos	Grados	Adicional	No. Parte
5/16"	1/4"	1/4"	2	7.5°	Fresa cola de milano	D-49529
3/8"	1/4"	3/8"	2	9°	Fresa cola de milano	D-49535
1/2"	1/4"	1/2"	2	14°	Fresa cola de milano	D-49541
7/8"	1/2"	3/4"	2	7°	Fresa cola de milano	D-49563

Fresa para ensamble CT



A	B	C	Filos	Adicional	Empaque piezas	No. Parte
3/8"	1/2"	1/4"	2	Fresa ensamble	1	D-50061
3/8"	1/2"	1/2"	2	Fresa ensamble	1	D-50077

Fresa para redondear CT



A	B	C	Filos	Adicional	Empaque piezas	No. Parte
1/8"	3/8"	1/4"	2	Fresa para redondear	1	D-49769
3/16"	1/2"	1/4"	2	Fresa para redondear	1	D-49775
1/4"	17/32"	1/4"	2	Fresa para redondear	1	D-49781
5/16"	9/16"	1/4"	2	Fresa para redondear	1	D-49797
3/8"	21/32"	1/4"	2	Fresa para redondear	1	D-49806
1/2"	3/4"	1/4"	2	Fresa para redondear	1	D-49812
3/4"	1/2"	1/2"	2	Fresa para redondear	1	D-49828

Fresa romana CT



A	B	C	Filos	Adicional	Empaque Piezas	No. Parte
5/32"	1/2"	1/4"	2	Fresa romana	1	D-50083
1/4"	11/16"	1/2"	2	Fresa romana	1	D-50099

Fresa ojo de cerradura CT



A	B	C	Filos	Adicional	Empaque piezas	No. Parte
3/8"	13/32"	1/4"	1	Fresa ojo de cerradura	1	D-50217

Fresa para moldura CT



A	B	C	Filos	Adicional	Empaque piezas	No. Parte
3/16"	1/2"	1/4"	2	Fresa para moldura	1	D-49840
1/4"	17/32"	1/4"	2	Fresa para moldura	1	D-49856
5/16"	9/16"	1/4"	2	Fresa para moldura	1	D-49862
3/8"	21/32"	1/4"	2	Fresa para moldura	1	D-49878
1/2"	3/4"	1/4"	2	Fresa para moldura	1	D-49884

Fresa ranuradora CT



A	B	C	Filos	Adicional	Empaque Piezas	No. Parte
1/2"	5/64"	1/4"	2	Fresa ranuradora	1	D-50245
1/2"	3/32"	1/4"	2	Fresa ranuradora	1	D-50251
1/4"	1/8"	1/4"	2	Fresa ranuradora	1	D-50267
1/2"	5/32"	1/4"	2	Fresa ranuradora	1	D-50273
1/2"	3/16"	1/4"	2	Fresa ranuradora	1	D-50289
1/2"	7/32"	1/4"	2	Fresa ranuradora	1	D-50295

Fresa media caña CT



A	B	C	Filos	Adicional	Empaque piezas	No. Parte
3/16"	1/2"	1/4"	2	Fresa media caña	1	D-49943
3/8"	17/32"	1/4"	2	Fresa media caña	1	D-49965
1/2"	5/8"	1/4"	2	Fresa media caña	1	D-49971

Fresa para exhibidor de panel CT



A	B	C	Filos	Adicional	Empaque Piezas	No. Parte
1/2"			2		1	D-61868

Fresa recta 2 filos con balero superior



A	B	C	Filos	Adicional	Empaque piezas	No. Parte
1/2"	1/4"	1/4"	2	Fresa recta	1	D-58497
1/2"	1"	1/4"	2	Fresa recta	1	D-58506

Fresa recta súper



A	B	C	Filos	Adicional	Empaque Piezas	No. Parte
1/2"	2"	1/2"	2		1	D-62810

Juego de fresas para router

Punta ranuradora 1/4"

Punta bisel 1/2"

Punta media luna 1/2"



Nota	No. Parte
3 piezas	D-16461
Edición de aniversario <small>*Hasta agotar existencias</small>	D-53344

Fresa recta patern

A	B	C	Filos	Adicional	Empaque Piezas	No. Parte
3/4"	1"	1/2"	2		1	D-62826

Fresa p/enrasar formaica con balero



A	B	C	Filos	Adicional	Empaque Piezas	No. Parte
1/2"	1-1/2"	1/2"	2	Fresa p/ enrasar	1	D-62832
1/2"	2"	1/2"	2	Fresa p/ enrasar	1	D-62848
3/4"	1"	1/2"	2	Fresa p/ enrasar	1	D-62854
3/4"	1-1/4"	1/2"	2	Fresa p/ enrasar	1	D-62860

Línea de fresas para router zanco 1/2"

Fresa recta 1 filo



A	B	C	Filos	Adicional	Empaque piezas	No. Parte
1/4"	3/4"	1/2"	1	Fresa recta	1	D-62739
3/8"	1"	1/2"	1	Fresa recta	1	D-62745

Fresa p/ ranurar, Media caña



A	B	C	Filos	Adicional	Empaque piezas	No. Parte
3/8"	1/2"	1/2"	2	Fresa ranuradora	1	D-62876
1/2"	3/4"	1/2"	2	Fresa ranuradora	1	D-62882
3/4"	1"	1/2"	2	Fresa ranuradora	1	D-62898

Fresa recta 2 filos



A	B	C	Filos	Adicional	Empaque piezas	No. Parte
1/4"	3/4"	1/2"	2	Fresa recta	1	D-62751
5/16"	1"	1/2"	2	Fresa recta	1	D-49183
1/2"	1"	1/2"	2	Fresa recta	1	D-62767
1/2"	1-1/2"	1/2"	2	Fresa recta	1	D-62773
3/4"	1"	1/2"	2	Fresa recta	1	D-62789
3/4"	1-1/2"	1/2"	2	Fresa recta	1	D-62795
7/8"	1"	1/2"	2	Fresa recta	1	D-62804

Fresa p/ranurar en "V"



A	B	C	Filos	Adicional	Empaque piezas	No. Parte
1/2"	1/2"	1/2"	2	Fresa ranuradora	1	D-49404
5/8"	1/2"	1/2"	2	Fresa ranuradora	1	D-49410
7/8"	5/8"	1/2"	2	Fresa ranuradora	1	D-62907
3/4"	5/8"	1/2"	2	Fresa ranuradora	1	D-49426
1"	3/4"	1/2"	2	Fresa ranuradora	1	D-62913
1-1/8"	7/8"	1/2"	2	Fresa ranuradora	1	D-49432

Fresa tipo "V"



A	B	C	Filos	Adicional	Empaque piezas	No. Parte
1/4"	1/4"	1/2"	2	Fresa tipo V	1	D-62929
5/16"	5/16"	1/2"	2	Fresa tipo V	1	D-62935
3/8"	3/8"	1/2"	2	Fresa tipo V	1	D-62941
1/2"	3/8"	1/2"	2	Fresa tipo V	1	D-62957
5/8"	1/2"	1/2"	2	Fresa tipo V	1	D-49498
3/4"	1/2"	1/2"	2	Fresa tipo V	1	D-49507
1"	5/8"	1/2"	2	Fresa tipo V	1	D-49513
1"	11/16"	1/2"	2	Fresa tipo V	1	D-62963
1-1/4"	3/4"	1/2"	2	Fresa tipo V	1	D-62979
1-1/2"	7/8"	1/2"	2	Fresa tipo V	1	D-62985

Fresa cola de milano



A	B	C	Filos	Adicional	Empaque piezas	No. Parte
3/8"	3/8"	1/2"	2	Fresa cola de milano	1	D-62991
1/2"	1/2"	1/2"	2	Fresa cola de milano	1	D-63002
1"	7/8"	1/2"	2	Fresa cola de milano	1	D-49579

Fresa clasica



A	B	C	Filos	Adicional	Empaque piezas	No. Parte
1"	5/8"	1/2"	2	Fresa clasica	1	D-49694
1-1/4"	3/4"	1/2"	2	Fresa clasica	1	D-49703

Fresa p/ ranurar Romana



A	B	C	Filos	Adicional	Empaque piezas	No. Parte
3/4"	7/16"	1/2"	2	Fresa romana	1	D-63018

Fresa p/ perfilar



A	B	C	Filos	Adicional	Empaque Piezas	No. Parte
3/4"	3/8"	1/2"	2	Fresa p/ perfilar	1	D-63024
1/2"	1"	1/2"	2	Fresa p/ perfilar	1	D-63030

Fresa p/ redondear



A	B	C	Filos	Adicional	Empaque Piezas	No. Parte
5/8"	15/32"	1/2"	2	Fresa p/ redondear	1	D-63046
3/4"	3/8"	1/2"	2	Fresa p/ redondear	1	D-63052
1-1/4"	21/32"	1/2"	2	Fresa p/ redondear	1	D-63068
1-1/2"	3/4"	1/2"	2	Fresa p/ redondear	1	D-63074

Fresa cóncava con balero



A	B	C	Filos	Adicional	Empaque Piezas	No. Parte
1-1/4"	17/32"	1/2"	2	Fresa cóncava	1	D-63080
1-1/2"	5/8"	1/2"	2	Fresa cóncava	1	D-63096
1-3/4"	3/4"	1/2"	2	Fresa cóncava	1	D-63105
2"	7/8"	1/2"	2	Fresa cóncava	1	D-63111

Fresa p/ perfilados



A	B	C	Filos	Adicional	Empaque piezas	No. Parte
2"	1"	1/2"	2	Fresa p/ perfilados	1	D-49890

Fresa cóncava 2 filos c/ balero



A	B	C	Filos	Adicional	Empaque piezas	No. Parte
1-1/4"	19/32"	1/2"	2	Fresa cóncava	1	D-63127

Fresa p/ biselar 45° con balero



A	B	C	Filos	Adicional	Empaque piezas	No. Parte
1-3/4"	29/32"	1/2"	2	Fresa clasica	1	D-50049
2"	1-1/16"	1/2"	2	Fresa clasica	1	D-50055

Fresa recta p/ ensamble



A	B	C	Filos	Adicional	Empaque piezas	No. Parte
1-5/8"	1"	1/2"			1	D-50223

Fresa p/ barandilla Tipo pez

A	B	C	Filos	Adicional	Empaque piezas	No. Parte
1-1/8"	1-5/8"	1/2"	2	Fresa tipo pez	1	D-50158

Fresa p/ machi-hembrar



A	B	C	Filos	Adicional	Empaque piezas	No. Parte
1-39/64"	3/4"	1/2"	4		1	D-50239

Fresa p/ moldura cóncava



A	B	C	Filos	Adicional	Empaque piezas	No. Parte
1-3/4"	1-1/8"	1/2"	2	Fresa cóncava	1	D-50164

Fresa piloto p/ copiar



A	B	C	Filos	Adicional	Empaque piezas	No. Parte
1/2"	1-1/8"	1/2"	2	Fresa piloto	1	D-63133

Fresa p/ moldura multiforma



A	B	C	Filos	Adicional	Empaque piezas	No. Parte
2-1/4"	1-7/8"	1/2"	2	Fresa cóncava	1	D-50186

Fresa p/ bisagra



A	B	C	Filos	Adicional	Empaque piezas	No. Parte
1/2"	3/4"	1/2"	2	Fresa p/ bisagra	1	D-63149

Fresa p/ machi-hembrar Reversible



A	B	C	Filos	Adicional	Empaque piezas	No. Parte
1-5/8"	29/32"	1/2"		Macho	1	D-50192
1-5/8"	29/32"	1/2"		Hembra	1	D-50201

Fresa p/ moldura, Naríz de toro



A	B	C	Filos	Adicional	Empaque piezas	No. Parte
7/8"	3/4"	1/2"	2	Fresa p/ moldura	1	D-63155

Fresa p/ moldura, Romana



A	B	C	Filos	Adicional	Empaque piezas	No. Parte
1-1/4"	1-27/64"	1/2"	2	Fresa p/ moldura	1	D-63161

Fresa p/ ranurar "V"

A	B	C	Filos	Adicional	Empaque piezas	No. Parte
3/8"	3/8"	1/2"	2	Fresa p/ranurar	1	D-63177

Fresa p/ moldura cóncava y convexa



A	B	C	Filos	Adicional	Empaque piezas	No. Parte
1"	11/16"	1/2"	2	Fresa p/ moldura	1	D-63183
1-1/8"	3/4"	1/2"	2	Fresa p/ moldura	1	D-63199

Fresa nariz de toro c/ balero



A	B	C	Filos	Adicional	Empaque piezas	No. Parte
3/4"	5/8"	1/2"	2	Fresa nariz de toro	1	D-63208
7/8"	1"	1/2"	2	Fresa nariz de toro	1	D-63214
1/2"	1"	1/2"	2	Fresa nariz de toro	1	D-63220

Fresa p/ moldura clasica



A	B	C	Filos	Adicional	Empaque piezas	No. Parte
1-3/8"	5/8"	1/2"	2	Fresa tipo pez	1	D-63236

Fresa p/ moldura triple grano



A	B	C	Filos	Adicional	Empaque piezas	No. Parte
7/8"	1"	1/2"	2	Fresa cóncava	1	D-63242

Fresa p/ barandilla



A	B	C	Filos	Adicional	Empaque piezas	No. Parte
1-3/8"	1-1/2"	1/2"	2	Fresa cóncava	1	D-63258

Set de 6 fresas para router

No. Parte **D-53578**

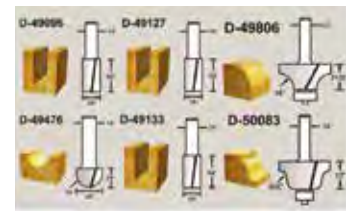

Diámetro	Longitud	Radio	Ángulo	Zanco	Cojinete	Flauta	No. Parte
1/4"	5/8"	-	-	1/4"	-	2	D-49096
3/8"	3/4"	-	-	1/4"	-	2	D-49127
1/2"	3/4"	-	-	1/4"	-	2	D-49133
1/2"	3/8"	1/4"	-	1/4"	-	2	D-49476
1-1/4"	21/32"	3/8"	-	1/4"	1/2"	2	D-49806
1-1/8"	1/2"	5/32"	-	1/4"	1/2"	2	D-50083

Set de 12 fresas para router

No. Parte **D-53584**

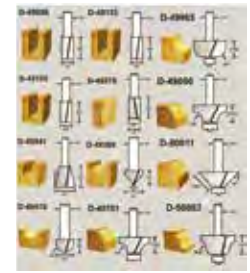

Diámetro	Longitud	Radio	Ángulo	Zanco	Cojinete	Flauta	No. Parte
1/4"	5/8"	-	-	1/4"	-	2	D-49096
1/2"	3/4"	-	-	1/4"	-	2	D-49133
5/8"	3/4"	-	-	1/4"	-	2	D-49155
1/2"	1/2"	-	-	1/4"	1/2"	2	D-49270
1/2"	1/2"	-	14dg	1/4"	-	2	D-49541
1/2"	1/2"	-	90dg	1/4"	-	2	D-49389
1/2"	3/8"	1/4"	-	1/4"	-	2	D-49476
1"	17/32"	1/4"	-	1/4"	1/2"	2	D-49781
1/1/4"	21/32"	3/8"	-	1/4"	1/2"	2	D-49806
1-1/4"	17/32"	3/8"	-	1/4"	1/2"	2	D-49965
1-1/4"	17/32"	-	45dg	1/4"	1/2"	2	D-50011
1-1/8"	1/2"	5/32"	-	1/4"	1/2"	2	D-50083



ACCESORIOS PARA EQUIPO EXTERIOR

Accesorios para multiherramienta

UX01G / DUX60 / DUX18

Amplia gama de accesorios opcionales.

Con los diversos accesorios se pueden utilizar en cualquiera de las multiherramientas se pueden realizar muchas tareas, como podar árboles, podar césped, hacer acabados en setos, cultivar, limpiar patios o áreas verdes, cortar troncos, etc.. todo con una sola herramienta.

UX01G

40V^{Li-ion} max

Salida máxima 1.0kw

3-Configuraciones de velocidad
Luz LED de precaución

Botón de reversa

Botón de encendido y apagado

Luz LED de precaución

Sobrecarga

Sobrecalentamiento

Sobredescarga

NUEVO

Palanca de bloqueo

Interruptor de gatillo con control de velocidad variable

WG WET GUARD
La alta resistencia al agua permite operar la máquina incluso si está mojada.



DUX60

18V + 18V 36V

Salida máxima 0.6kw

3-Configuraciones de velocidad
LED de energía

Botón de reversa

Botón de encendido y apagado

Palanca de bloqueo

Interruptor de gatillo con control de velocidad variable

XPT
Tecnología de Protección Extrema



DUX18

18V LITHIUM-ION

Salida máxima 0.47kw

2-Configuraciones de velocidad

Botón de encendido y apagado

Palanca de bloqueo

Interruptor de gatillo con control de velocidad variable

XPT
Tecnología de Protección Extrema



Cambio fácil de accesorios

El sistema de bloqueo tipo palanca que permite una instalación rápida sin herramientas y reemplazo de los accesorios.



Excelente movilidad y transporte

El sistema dividido del cabezal y los accesorios proporciona una movilidad más fácil. La bolsa de herramientas opcional facilita aún más el transporte y el almacenamiento.



Equipadas con motor BL

Todas las multiherramientas cuentan con motor sin carbones, que esta libre de mantenimiento y más trabajo con una sola carga de batería

Accesorios

1 Cosechadora de café	2 Extensión articulada a raz de suelo	3 Cortasetos recto	4 Cortasetos multiposiciones	5 Sierra de altura	6 Cultivador Diá.externo de la cuchilla del rotor 220 mm	7 Orilladora	8 Desbrozadora	9 Cepillo barredor	10 Cultivador Diá.externo de la cuchilla del rotor 232 mm	11 Rodillo barredor	12 Extensión de eje
---------------------------------	---	------------------------------	--	------------------------------	--	------------------------	--------------------------	------------------------------	---	-------------------------------	-------------------------------

*Los accesorios se venden por separado

1
EJ400MP
195720-0

2
EN420MP
198058-2

3
EN410MP
197738-7

4
EN401MP
196303-9

5
EY401MP
196100-3

6
KR401MP
199184-0

7
EE400MP
196749-9

8
EM403MP
198765-7

9
BR400MP
199321-6

10
KR400MP
199184-0

11
SW400MP
199342-8

12
LE400MP
191E23-6

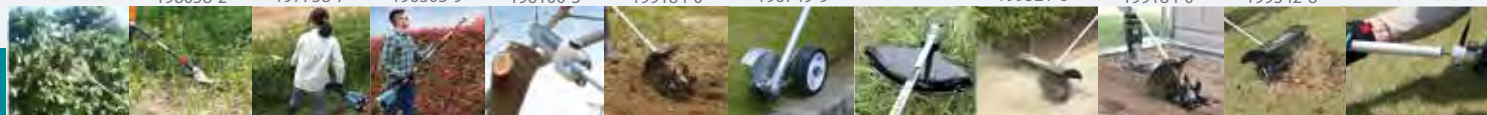



Accesorios para desbrozadora

Cuchillas

	Usar en	Aplicación	Medidas	Empaque Pieza	No. Parte
	RBC411, RBC411U, RBC412U	Para corte de ramas cuchilla 2 filos		1	195624-6
NUEVO 		Cuchilla curva de 3 filos plásticos para segar hierba alta		1	198384-9
NUEVO 		Repuesto de cuchilla curva de 3 filos plásticos para segar hierba alta		12	198427-7
		Repuesto de cuchilla recta plástica	225mm	1	197189-4
	EBH340U EM4351UH EM4350UH	Para corte de ramas y arbustos. cuchilla 3 filos 255mm		1	195299-1
	EBH252U	Para corte de ramas y arbustos. cuchilla 3 filos 230mm		1	195298-3
		Para corte de ramas y arbustos. cuchilla 3 filos 230mm		1	195300-2
	EM2653L	Cuchilla 230mm	230mm	1	197808-2
	EM2500U	Para corte de césped y arbustos. 4 dientes (cruceta)	255mm x 25.4mm x 1.4mm	1	B-14124
	EM2500U	Para corte de césped y arbustos, 4 Filos.	230mm x 25.4mm x 2.0mm	1	DA00000169
	EM2500U	Para corte de césped y arbustos, 4 filos. (con empaque)	255mm x 25.4mm x 1.8mm	1	DA00000181
		Cuchilla 8 filos tipo remolino	230mm x 1.8mm	1	B-14130
		Cuchilla 8 filos tipo remolino	230mm x 1.8mm x 25.4mm 8 dientes	1	D-73324
NUEVO 		Corte de césped y ramas jóvenes	230mm x 1.8mm x 25.4mm 80 dientes	1	D-73879
NUEVO 		Corte de césped y ramas jóvenes	255mm x 2.0mm x 25.4mm 80 dientes	1	D-73885

Cuchillas

	Usar en	Aplicación	Medidas	Empaque Pieza	No. Parte
		Cuchilla 8 filos tipo remolino	255mm x 2.0mm	1	B-14146
		Para corte de ramas y arbustos, tipo sierra, con dientes de carburo de tungsteno 40 dientes	230mm x 32mm	1	A-56932

Cuchillas

Línea económica

	Usar en	Dientes	Medidas	Empaque Pieza	No. Parte
		4	230mm x 1.8mm	1	D-66008
		4	255mm x 2.0mm	1	D-66014
		3	230mm x 3.0mm		D-66020
		3	257mm x 3.0mm		D-66036
		3	305mm x 3.0mm		D-66042
		2	230mm x 2.0mm		D-66058
		2	255mm x 2.0mm		D-66064
		36 TCT	230mm x 2.0 - 1.25mm		D-65981
		40 TCT	255mm x 2.0 - 1.25mm		D-65997

El equipo estándar (accesorios), las especificaciones y las fotografías pueden variar. Los accesorios pueden no estar incluidos desde origen con las herramientas, aunque se indiquen en este catálogo.

Cortasetos recto



Para usar en	Aplicación	Empaque piezas	No. Parte
Desbrozadoras a gasolina 2 ó 4 Tiempos	Recorte de ramas y arbustos con acabado estético	1	A-89523

Cabezales para hilo



Usar en	Descripción / Aplicación	Medidas	Empaque Piezas	No. Parte
NUEVO Universal	Set de cabezal de nylon para desbrozadoras Instalación fácil	4" (102mm) hilo M8x1.25LH 4mx2mm	1	191D91-7
NUEVO Universal	Set de cabezal de nylon para desbrozadoras Instalación fácil	4" (102mm) hilo M8x1.25LH 4mx2mm	1	191D92-5
NUEVO Universal	Set de cabezal de nylon para desbrozadoras Instalación fácil	4" (102mm) hilo M10x1.25LH 4mx2mm	1	191D89-4
NUEVO Universal	Set de cabezal de nylon para desbrozadoras Instalación fácil	4" (102mm) hilo M10x1.25LH 3mx2.4mm	1	191D90-9
NUEVO Universal	Set de cabezal de nylon para desbrozadoras Instalación fácil	5" (130mm) hilo M10x1.25LH 4mx2.4mm	1	191D93-3
Universal	Corte de césped, sistema de cuerda autoalimentable, giro izquierdo incluye adaptadores	110 x 8 x 1.25mm (Rh)	1	B-60109
EM2500U RBC251	Corte de césped, sistema de cuerda autoalimentable, giro derecho incluye adaptadores	110 x 8 x 1.25 mm (Lh)	1	B-60143
EM4250,EM4340 EBH252	Corte de césped, sistema de cuerda autoalimentable, giro izquierdo	110 x 6 x 1.25mm (Lh)	1	A-89121
EM2500U	Corte de césped, sistema de cuerda autoalimentable, giro izquierdo	125 x 6 x 1.25mm (Lh)	1	A-89143
EBH340U	Corte de césped, sistema de cuerda autoalimentable, giro izquierdo	125 x 6 x 1.25mm (Lh)	1	1229314
EBH252U,EM4340, EBH340U,RBC411	Corte de césped, sistema de cuerda autoalimentable, giro izquierdo	M10 x1.25 LH	1	1951490
EM4340,EBH340U, RBC411,RBC420	Corte de césped, sistema de cuerda autoalimentable, giro izquierdo	M10 x 1.25 LH	1	A-81658
Universal	Corte de césped, sistema manual P/ suministro de cuerda	4-1/2"	1	B-02951
EM4350UH, EM4351UH	Cabeza recortadora ultra-auto 6		1	122882-1
	Cabeza recortadora c/ centro metálico		1	197030-1
EM2653L	Cortador de ensamble 95-M10L		1	197804-0

Protectores y guardas



Características	Empaque piezas	No. Parte
Protector ASSY	1	135465-8
Protector completo	1	140424-9
Protector con extensión	1	135398-7
Protector	1	6348001001

Protectores y guardas



Características	Empaque piezas	No. Parte
Protector	1	6348001000
Protector	1	6258028002
Protector	1	6258060001
Protector	1	6258061001
Jgo. de protector 420 Usar en EM2653L	1	197806-6
Guarda inferior para desbrozadora Para BC300LD	1	140583-9

Hilo de nylon para inalámbricos



Características	Empaque piezas	No. Parte
Hilo de nylon 2.0 p/ DUR364L	15mt	197472-9
Hilo de nylon 2.0 p/ DUR364L	30mt	197473-7
Hilo de nylon 2.0 p/ DUR364L	160mt	197474-5
Hilo de nylon 2.0 p/ DUR364L	280mt	197475-3
NUEVO Hilo de nylon 1.65 forma trébol	15mt	198859-8
NUEVO Hilo de nylon 1.63 forma trébol	30mt	198862-9

Hilo de nylon Línea Profesional



B-01971	HILO NYLON REDONDO 2.4mm x 5m
B-07375	HILO NYLON REDONDO 3.0mm x 4m
T-02375	HILO NYLON REDONDO 2.0mm x 270m
T-02381	HILO NYLON REDONDO 2.5mm x 170m
T-02397	HILO NYLON REDONDO 3 mm x 120m.
T-02406	HILO NYLON CUADRADO 2 mm x 230m.
T-02412	HILO NYLON CUADRADO 2.5 mm x 140m.
T-02428	HILO NYLON CUADRADO 3 mm x 100m.
T-02434	HILO NYLON CUADRADO/RECUBIERTO 3 mm x 120m

Hilo de nylon para inalámbricos

NUEVO

Guía de color

Diámetro	Color / Forma	Trabajo ligero		Trabajo de alta demanda	
		Baja Densidad	Alta densidad	Baja Densidad	Alta densidad
1.3mm	○	◀▶			
1.6mm - 1.65mm	⊕ ⊙	◀▶			
2.0mm	⊕ ⊙		◀▶		
2.4mm	⊕ ⊙ □		◀▶	◀▶	
2.7mm	⊕			◀▶	◀▶
3.0mm	○ □			◀▶	◀▶

Hilo de nylon Línea Industrial



Color / Forma	Diámetro (mm)	Longitud (m)	No. de parte
○ Redondo	1.3mm	15m	E-02727
⊕ Redondo	1.6mm	15m	E-02733
⊕ Redondo	2.0mm	15m	E-02705
	2.0mm	126m	E-02711
⊕ Redondo	2.4mm	15m	E-02749
	2.4mm	262m	E-02783
□ Cuadrado	2.4mm	15m	E-02808
	2.4mm	69m	E-02814
	2.4mm	206m	E-02820

Hilo de nylon Doble capa



Mayor durabilidad hasta un 130%* gracias a núcleo recubierto con una piel resistente a los impactos y la abrasión

*En comparación con el cordón de nylon estándar



Color / Forma	Diámetro (mm)	Longitud (m)	No. de parte
○ Redondo Doble capa	3.0mm	15m	E-02836
	3.0mm	56m	E-02842
	3.0mm	168m	E-02858
□ Cuadrado Doble capa	3.0mm	15m	E-02870
	3.0mm	44m	E-02886
	3.0mm	132m	E-02892

Hilo nylon en espiral en forma de trébol

Bajo nivel de ruido y ahorro de energía

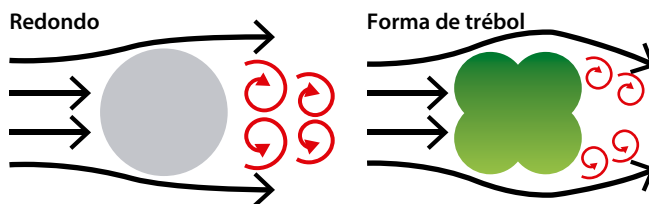

Redondo



Trébol

Gracias a su diseño en forma de trébol se reduce la resistencia al aire generando bajo nivel de ruido y ahorro de energía.

Cantidad de corte por carga

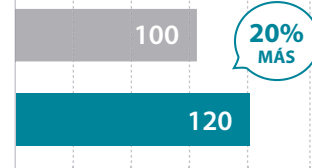

Ruido



Redondo



Trébol

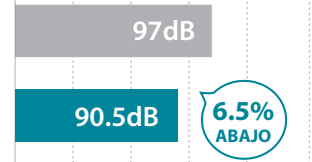

NUEVO

Color / Forma	diámetro (mm)	Longitud (m)	No de parte.
⊕ Forma de trébol	1.65	30	E-01747
⊕ Forma de trébol	2.0	30	E-01775
	2.0	310	E-01781
⊕ Forma de trébol	2.4	30	E-01806
	2.4	225	E-01812
⊕ Forma de trébol	2.7	30	E-01834
	2.7	180	E-01840

Complementos



Usar en	Aplicación	Medidas	Empaque Piezas	No. Parte
RBC411	Gancho soporte para herramienta		1	6417014150
Recolector	Tubo para recolector de café de 1.0m		1	1952496 1952527
EBH340R	Botella para mezcla de combustible 2 tiempos 25:1 botella de aceite		1	456236-3
EBH340R	Botella para mezcla de combustible 2 tiempos 25:1 botella de aceite		1	0722105000
Cabeza recortadora B60109	Juego de guías metálicas para hilo		Juego 2 pzs.	A-15992
EBH340R	Cubierta de plástico		1	6418027000
Varios	Llave de bujía p/ motosierras	6mm. (1/4")	1	941713001
EN5950SH	Barra guía p/ cortasetos		1	725184-0
EN5950SH	Laina guía p/ cortasetos		1	346666-5
EN5950SH	Cuchilla p/ cortasetos		1	332059-2
EX2650LHM	Maleta Makita		1	831342-9
EY2650H25H	Cadena 10" p/ motosierra de extensión		1	196142-7

Accesorios para equipo de combustión

Aspersores y adaptadores



Usar en	Descripción	Empaque Piezas	No. Parte
EBH1000X	Llave de paso	1	5929002000
EVH2000	Adaptador	1	ADAPTER
EVH2000	Medidor	1	6909035001
EVH2000	Tubo de aspersor	1	6909511501
EVH2000	Aspersor	1	6919500500

Cosechador de café

Sacude ramas



Usar en	Aplicación	Empaque Piezas	No. Parte
Desbrozadoras a gasolina 2 ó 4 tiempos	Sacude las ramas para desprender los frutos en plantas de café y olivos (aceituna)	1	B-80210
Desbrozadoras a gasolina 2 ó 4 tiempos	Sacude las ramas para desprender los frutos en plantas de café y olivos (aceituna)	1	B-80226
Desbrozadoras a gasolina 2 ó 4 tiempos	Sacude las ramas para desprender los frutos en plantas de café y olivos (aceituna)	1	195720-0

Accesorios para nebulizador PM7650H



Usar en	Aplicación	Empaque Piezas	No. Parte
PM7650H	Correa de hombro (L) izquierda	1	161509-8
PM7650H	Correa de hombro (R) derecha	1	161510-3
PM7650H	Set de boquillas 0.7/0.8mm	1	196499-6
PM7650H	Boquilla 0.5mm	1	196616-8
PM7650H	Tubo curvo 630 f	1	453507-9
PM7650H	Tubo recto 380	1	453700-5
PM7650H	Tubo recto 630	1	453699-4
PM7650H	Tapa pulverizadora	1	453506-1

Accesorios para sopladora

Usar en	Aplicación	Empaque Piezas	No. Parte
BHX2500	Kit bolsa recolectora P/BHX2500	1	197234-5
BHX2500	Boquilla plana P/BHX2500	1	6659501100
BHX2500	Kit bolsa recolectora P/BHX2500	1	6659504000
MUB105	Ensamble de bolsa para polvo	1	123241-2
DUB182 DUB183	Boquilla larga	1	TP00000199
DUB182 DUB183	Boquilla corta	1	132025-7
EB5300	Boquilla de punta plana P/EB5300	1	196911-6

Arnés para desbrozadora

Usar en	Aplicación	Empaque Piezas	No. Parte
Desbrozadoras a gasolina 2 ó 4 tiempos	Arnés de soporte para desbrozadoras	1	125802-4
Adecuado para EM4350LH	Arnés de soporte tipo sencillo (Para usuario del hogar)	1	126187-1
Adecuado para EM4350UH	Arnés de soporte trabajo medio pesado (Para usuario agricultor)	1	122906-3
Adecuado para EM4351UH	Arnés de soporte trabajo pesado (Para usuario profesional)	1	196129-9

Accesorios para herramienta inalámbrica

Descripción	Aplicación	Usar en	Empaque piezas	No. Parte
Cadena para motosierra	Sierra de cadena	5012B	1	196519-6



1 Espada: Fabricada cuidadosamente con la mejor aleación de acero para espada de cadena y larga vida.

2 Nariz: En el área de la nariz, la cadena no está en contacto con la espada, sino que está montada sobre la estrella, para menos fricción, mayor rendimiento y más larga vida.

Barras y cadenas para motosierra inalámbrica

Ideal para sierras de cadena inalámbricas

SERIE 80TXL

NUEVO

Diseño delgado que permite una mayor velocidad de corte

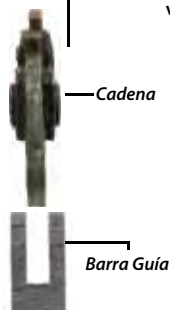

Revestimiento azul que ayuda a prevenir la oxidación



- CORTES MÁS RÁPIDOS
- BAJA VIBRACIÓN
- MÁS CORTES POR CARGA

Descripción	Empaque piezas	No. Parte
Barra guía para motosierra 12" (con Sprocket)	1	191T86-6
Barra guía para motosierra 14" (con Sprocket)	1	191T87-4
Barra guía para motosierra 16" (con Sprocket)	1	191T88-2
Cadena para motosierra 12" (Tipo 80TXL)	1	191T90-5
Cadena para motosierra 14" (Tipo 80TXL)	1	191T91-3
Cadena para motosierra 16" (Tipo 80TXL)	1	191T92-1
Barra guía para motosierra 18" (con Sprocket)	1	191X03-0
Cadena para motosierra 18" (Tipo 80TXL)	1	191X04-8

Barras para motosierra



Usar en	Descripción	Empaque piezas	No. Parte
DCS250T	Barra guía 10"	1	1684085
BUC122	Barra guía 10"	1	1584766
BUC122	Barra guía 10"	1	1684506
EA3202S / DVC3202	Barra guía 12"	1	165245-8

Barra guía para motosierra

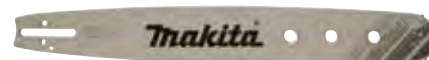

Tipo de nariz	Longitud	Paso	Calibre	Usar en	No. Parte
Sólida	11.5cm/4-1/2"	3/8"	0.043"	UC120D	158476-6
Sprocket	35cm/14"	3/8"	0.050"	DCS34	165201C8
Sólida	35cm/14"	3/8"	0.050"	EA3200530A	442035661
Sprocket	40cm/16"	3/8"	0.050"	DCS460, EA3200540A, DCS3416, EA3200530A	165202D6
Sólida	45cm/18"	3/8"	0.058"	DCS6401	445045455
Sprocket	45cm/18"	3/8"	0.058"	DCS50018, DCS7301	445045651
Sólida	50cm/20"	3/8"	0.058"	DCS7301	445050455
Sprocket	50cm/20"	3/8"	0.058"	DCS640120	445050655
Sprocket	53cm/21"	3/8"	0.058"	DCS5200, DCS520	445050651
Sprocket	50cm/20"	3/8"	0.058"	DCS510, DCS200	443053661
Sólida	60cm/24"	3/8"	0.058"	DCS640124	445060455
Sólida	70cm/28"	3/8"	0.058"	DCS730128, DCS7901	445070455
Sólida	74cm/29"	3/8"	0.058"	DCS730128, DCS910	445074452

Funda para barras

	Aplicación	Empaque piezas	No. Parte
	Cubierta de barra guía para BUC122	1	416311-7

Cadenas para motosierra



Longitud	Paso	Calibre	Forma del diente	Usar en	No. Parte
40cm/16"	3/8"	0.050"	HALF	DCS3400/DCS4300	531492656
45cm/18"	3/8"	0.058"	HALF	DCS460, DCS6000	523093664
53cm/21"	3/8"	0.058"	HALF	DCS461, DCS6000	523093672
45cm/18"	3/8"	0.058"	FULL	DCS4600, DCS6000	528099664
53cm/21"	3/8"	0.058"	FULL	DCS5000, DCS6000	528099672
45cm/18"	3/8"	0.058"	FULL	DCS6400	528099668
60cm/24"	3/8"	0.058"	FULL	DCS7300	528099684
70cm/28"	3/8"	0.058"	FULL	DCS7301	528099694
74cm/29"	3/8"	0.058"	FULL	DCS9010	528099696
12"				EA3202	196740-7

El equipo estándar (accesorios), las especificaciones y las fotografías pueden variar. Los accesorios pueden no estar incluidos desde origen con las herramientas, aunque se indiquen en este catálogo.

Limas para motosierra / sierra de cadena



Descripción	Medida	Usar en	No. Parte
Lima plana	19x1.5x0.2mm		953003060
Lima redonda	4.8mm(3/16")	DCS461, DCS4600S, DCS5001	953003070
Lima redonda	4.5mm(11/64")	UC3020A, UC3520A, UC4020A	953003100
Lima redonda	4mm(5/32")		953003090
Mango para lima			953004010
Calibrador para cadena	1/4"		953100090

Limas para sierra de cadena



NUEVO

Descripción	Medida	Usar en	No. Parte
Lima redonda	5/32"	Lima	D-67359
Lima redonda	11/64"	Lima	D-67371
Lima redonda	3/16"	Lima	D-67393
Lima redonda	13/64"	Lima	D-67418
Lima redonda	7/32"	Lima	D-67430
Lima plana	6"	Lima	D-67452

Limas para motosierra Zanco 1/4" Hex



NUEVO

Descripción	Medida	Usar en	No. Parte
Lima para motosierra zanco 1/4" Hex	5/32" (4.0mm)		D-73748
Lima para motosierra zanco 1/4" Hex	11/64" (4.5mm)	Taladro Atornillador o atornillador de impacto	D-73754
Lima para motosierra zanco 1/4" Hex	3/16" (4.8mm)		D-73760
Lima para motosierra zanco 1/4" Hex	13/64" (5.2mm)	Para limar cadena de sierras de cadena	D-73776
Lima para motosierra zanco 1/4" Hex	7/32" (5.5mm)		D-73782

Limas para sierra de cadena

NUEVO

Descripción	Medida	No. Parte
<p>Set de afilado (lima redonda y soporte) para afilar la placa lateral y esquina de corte en las cadenas de motosierras</p>	4mm (5/32")	D-70948
	4.5mm(11/64")	D-70954
	4.8mm (3/16")	D-70960
	5.2mm (13/64")	D-70976
	5.5mm (7/32")	D-70982
<p>Set de afilado (lima plana y medidor de profundidad) para rectificar cadena de motosierras</p>		D-70998

Calibrador de profundidad



Medida	Usar en	No. Parte
143mm	Sierra de cadena	D-67474

Prensa para afilar



Descripción	Usar en	No. Parte
Prensa tipo estaca p/ afilar cadena	Sierra de cadena con limas	D-67480

Mango de plástico para lima para sierra de cadena



Descripción	Usar en	Tamaño	Empaque piezas	No. Parte
Mango de plástico	Lima redonda o plana	100mm	1	D-67496

Repuesto de aceite lubricante para cadena



Descripción	Usar en	Empaque piezas	No. Parte
Repuesto de aceite lubricante para cadena	5012B BUC250	1	182229-1

Set de afilado para cadena de cuchilla Bolsa enrollable

NUEVO



Descripción	Contenido	Empaque piezas	No. Parte
Set de afilado para cadena con estuche textil enrollable	Lima redonda 4.0mm (5/32") X2 soporte, mango X2, medidor de profundidad, lima plana	7 pzs	D-72154
Set de afilado para cadena con estuche textil enrollable	Lima redonda 4.5mm (11/64") X2 soporte, mango X2, medidor de profundidad, lima plana	7 pzs	D-72160
Set de afilado para cadena con estuche textil enrollable	Lima redonda 4.8mm (3/16") X2 soporte, mango X2, medidor de profundidad, lima plana	7 pzs	D-72176
Set de afilado para cadena con estuche textil enrollable	Lima redonda 5.2mm (13/64") X2 soporte, mango X2, medidor de profundidad, lima plana	7 pzs	D-72182
Set de afilado para cadena con estuche textil enrollable	Lima redonda 5.5mm (7/32") X2 soporte, mango X2, medidor de profundidad, lima plana	7 pzs	D-72198

LÍNEA DE RESCATE

Accesorios para utilizar con herramienta inalámbrica, miniesmeril o cortadora a gasolina y motosierras en **LABORES DE RESCATE**

CADENAS Y ESPADAS para motosierras

Capaz de cortar puertas de coche materiales compuestos o madera con clavos, concreto aireado y resinas



Descripción	Diente	Material	Piezas empaque	No. parte
Kit de rescate: Cadena 380mm, barra y limitador		para metal	1	957415030
Cadena de rescate 380mm	TCT	para metal	1	957696056
Barra guía de rescate 380mm			1	415038751
Kit de rescate: Cadena 450mm, barra y limitador		para metal	1	957415040
Cadena de rescate 380mm	TCT	para metal	1	957696064
Barra guía de rescate 380mm, usar c/ 957696064			1	415045751
Kit de rescate: Cadena 430mm, barra y limitador		para metal	1	957415060
Barra guía de rescate 430mm			1	465043755
Tope de profundidad para usar c/ barra guía 415045751			1	957250100

Brocas Auger para cuadro 3/4"

Para DDG460 / DG001G / perforación de tierra

NUEVO



Medida: Pulgadas

Descripción	Diámetro	Longitud total	No. Parte
Broca Auger para tierra	4"	31-1/2"	E-07294
Broca Auger para tierra	6"	31-1/2"	E-07303
Broca Auger para tierra	8"	31-1/2"	E-07319
Extensión de barra con perno	-	21-1/4"	E-07325
Perno para broca auger	-	-	E-07331
Set de agarraderas para DDA460 / DDG460	-	-	191P11-3
Broca Auger para tierra (con perno)	2"	31-1/2"	E-13611
Broca Auger para tierra (con perno)	2-3/8"	31-1/2"	E-13627
Broca Auger para tierra (con perno)	3-5/32"	31-1/2"	E-13633
Cuchilla de reemplazo	2" (50mm)	-	E-13649
Cuchilla de reemplazo	2-3/8" (60mm)	-	E-13655
Cuchilla de reemplazo	3" (80mm)	-	E-13661

Brocas Auger recta para tierra

Para Taladros atornilladores con empuñadura lateral Zanco Hex Perforación de tierra

NUEVO



Medida: Pulgadas

Diámetro	Longitud total	Longitud trabajo	No. Parte
2-3/4" (70mm)	24" (600mm)	8" (200mm)	D-75437
4" (100mm)	24" (600mm)	8" (200mm)	D-75443

Brocas Auger para cuadro 3/4"

Para DTW1001 / Perforación de tierra



Medida: Pulgadas

Diámetro	Longitud total	Longitud trabajo	No. Parte
13/16"	600mm	500mm	B-54302
1"	600mm	500mm	B-54318
1-3/16"	600mm	500mm	B-54324
1-3/8"	600mm	500mm	B-54330

El equipo estándar (accesorios), las especificaciones y las fotografías pueden variar. Los accesorios pueden no estar incluidos desde origen con las herramientas, aunque se indiquen en este catálogo.

Broca para ahoyadora (motoperforador)



Usar en	Descripción	Empaque Piezas	No. Parte
PE3450H	Broca 2-14" x 2.5" x 30"	1	T-01862
PE3450H	Broca 3-1/4" x 3.5" x 30"	1	T-01878
PE3450H	Broca 4" x 5.2" x 30"	1	T-01884
PE3450H	Broca 6" x 7.5" x 30"	1	T-01890
PE3450H	Broca 8" x 9.5" x 30"	1	T-01909
PE3450H	Extensión para broca 12"	1	T-01915
PE3450H	Punta centradora para broca 3"	1	T-01921
PE3450H	Punta centradora para broca 1"	1	T-01937
PE3450H	Cuchillas reemplazables 4"	1	T-01943
PE3450H	Cuchillas reemplazables 6"	1	T-01959
PE3450H	Cuchillas reemplazables 8"	1	T-01965
PE3450H	Adaptador p/ broca de sthll	1	T-01971

Accesorios para bomba EPH1000X

No incluye bomba

Todos los accesorios se venden por separado



Usar en	Descripción	Empaque piezas	No. Parte
EPH1000X	Manguera de salida	1	K000117864
EPH1000X	Manguera de succión	1	K000113837
EPH1000X	Inyector	1	K000115180
EPH1000X	Pichanca	1	K000118193
EPH1000X	Cople	1	K000340781
EPH1000X	Abrazadera	1	K940019032

Accesorios para fumigadora

Tipo	Características / uso recomendado	No. Parte
1	Para los herbicidas de rociadura; también ideal para regar plantas o acondicionar al suelo	6908031000
2	Para hacer niebla que previene la difusión de la medicina	6958011000
3	Para aplicaciones de pesticida en general utilizando insecticidas, fungicidas, etc.	6958025000
4	Fumigador ancho con gran angular.	6949001000
5	Fumigador ancho con gran angular.	6958018000
6	Fumigador en forma circular	6909500100
7	Fumigador en forma circular	6919500000
8	Fumigador conveniente para invernadero por su inyector compacto	6939025000
9	La atomización o chorro se selecciona	6939028000
10	Botella de aceite	0722104800
11	Adaptador "Y" para EVH2000	1955656
12	Manguera del aspersor para EVH2000	6909039001



Cuñas



Usar en	Aplicación	Empaque Piezas	No. Parte
Auxiliar en el corte de troncos	Cuña metálica 25cm.	1	988070101
Auxiliar en el corte de troncos	Cuña plástica 14cm.	1	988070819
Auxiliar en el corte de troncos	Cuña plástica 20cm.	1	988070824

Careta de seguridad

	Descripción	Empaque pieza	No. Parte
	Careta de seguridad	1	T-02515
	Careta de seguridad	1	T-02521



Aceites para cadena

	Descripción	Empaque pieza	No. Parte
	Aceite biodegradable p/ cadena	5Lts.	980008211
	Aceite biodegradable p/ cadena	20Lts.	980008213
	Aceite biodegradable p/ cadena	55Lts.	980008217
	Aceite mineral p/ cadena	1L.	988002256
	Aceite mineral p/ cadena	60Lts.	988002265
	Aceite para cadena anticorrosión	250ml.	980008302
	Aceite para cadena biotop	1L.	980008610

Aceites para cadena

	Descripción	Empaque pieza	No. Parte
	Aceite para cadena biotop	5Lts.	980008611
	Aceite para cadena biotop (DOLMAR)	60Lts.	980008265
	Aceite para cadena	5L	988002658
	Aceite p/ motor de dos tiempos 1:50	5L	980008118
	Aceite dos tiempos DOLMAR	60L	980008270
	Aceite de dos tiempos sintético DOLMAR	100ml	980008104
	Aceite de dos tiempos sintético DOLMAR	1L	980008103
	Aceite de dos tiempos sintético DOLMAR	5L	980008102
	Aceite de cuatro tiempos especial para la EK7651H	220ml	195532-1

Lubricantes para motosierra

	Descripción	Empaque Pieza	No. Parte
	Aceite p/ motor de dos tiempos con dosificador DOLMAR	1L	980008112
	Aceite p/ motor de dos tiempos 1:50	100ml	980008606
	Aceite p/ motor de dos tiempos 1:50	1L	980008607

El equipo estándar (accesorios), las especificaciones y las fotografías pueden variar. Los accesorios pueden no estar incluidos desde origen con las herramientas, aunque se indiquen en este catálogo.



MISCELÁNEA

- BRIDAS, TUERCAS Y GUÍAS
- GUARDAS, PUÑOS Y RECOLECTORES DE POLVO
- MEZCLADORES
- ACCESORIOS PARA PISTOLAS TÉRMICAS
- ACCESORIOS PARA HIDROLAVADORAS
- EQUIPO DE SEGURIDAD

Bridas internas



Aplicación	Empaque piezas	No. Parte
Brida interna 35 p/ SP6000	1	224406-0
2708	1	224119-3
3901	1	224280-6
4130	1	224276-7
9049	1	224257-1
9105	1	224089-6
2414B (antigua),MT240	1	224385-2
4100C, 4112	1	224184-2
4100NH,4140,4200NH MCC400,MT410	1	224080-4
5007MG/ MGA	1	224151-7
5007NB,5008NB	1	224360-8
5007NB,5008NB	1	224223-8
5008MG, 5007	1	224411-7
5077B/ NB/ 5377MG	1	224268-6
9047, 9049, 9067/ L,9069,9079, 9617,GA7020,GA7021,GA9010C, GA9020,GA9030,GA9040S,MGA700, MGA900,MT901	1	224378-9
9523NB/NB/HN,MGA400, MT951,9560CV	1	224377-1
9551, MGA450, MT952 9554NB/HN,9557NB/HN/PB,GA4530	1	224399-1
GA7001/ L	1	224111-9
GA9030	1	224083-8
GC5000	1	224207-6
LC1210,LC1230	1	224308-0
LS1016	1	224428-0
LS1020	1	224241-6
LS1216	1	224431-1
LS1440	1	224264-4
MSS700,MT580	1	224395-9
N5900B	1	224303-0
N9503BH	1	224298-7
GS6000	1	224458-1

Bridas internas externas



Aplicación	Empaque piezas	No. Parte
LS1030 (antigua)	1	224274-1
2702,2703,LF1000,LH1040F,LS1013, LS1030N,LS1040/ F,LS1211,LS1214, LS1220,LS1221	1	224333-1
5007NB/NH/NL,5008NB,5037NB, 5057NB,5277B/NB,5377MG,5740NB, B55610,LS0714FL	1	224275-9
2414NB, MLC140, MT240	1	224299-5
GB600, GB601	1	6004

Bridas externas

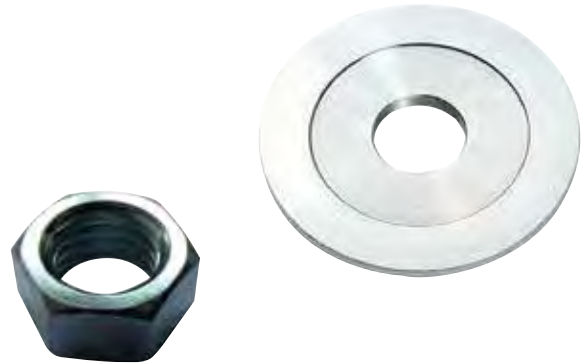

Aplicación	Empaque piezas	No. Parte
Brida externa 35 p/ SP6000	1	224405-2
3901	1	224505-8
4131	1	224366-6
9105	1	224019-7
9105	1	224090-1
9105	1	224501-6
2414 (antigua)	1	224137-1
2702, 2703, 2704	1	224347-0
4100NH, 4140, 4200NH, MCC400, MT410	1	224081-2
5007MG,5008MG,B55611	1	224409-4
5201NA	1	224160-6
5900B	1	224118-5
9000BL	1	224517-1
9005,9015BD,9047,9049,9067L, 9069,9079,9505BH,9524/NB, 9527/NB/PB,9561/C/CV, 9564/C/CV/CVR/PC/PCV, 9617,BGA452,GA4530, G5010,GA7020,GA7021, GA9010,GA9020,GA9030, GA9040S,MGA450,MGA700, MGA900,MT901,MT952	1	224568-4
GA7001/ L	1	224512-1
GA9030	1	224256-3
GB800	1	8003
LC1210,LC1230	1	224379-7
LS1016	1	224429-8
LS1216	1	224432-9
LS1440	1	224310-3
MGA400,MT951	1	224573-1
MLS100	1	JM23000065
MSS700,MT580	1	224396-7
PC1100	1	224526-0
SG1250	1	224577-3
GS6000	1	224467-0

Accesorios para sierras

Guías paralelas



Usar en	Aplicación	Tipo	Empaque Piezas	No. Parte
5037NB,5900B	Auxiliar para cortes rectos	Guía paralela	1	164021-7
5077NB,5740NB	Auxiliar para cortes rectos	Guía paralela	1	164095-8
2704	Con transportador y guía deslizable	Regla guía	1	194241-9
2702,2703	Guía de grados con transportador	Regla guía	1	122555-6
2704,2705	Guía de grados con transportador	Regla guía	1	122735-4
LF1000	Guía de grados con transportador	Regla guía	1	122730-4
LF1000	Guía deslizable	Regla guía	1	122729-9
LH1040F	Guía deslizable	Regla guía	1	122707-9
LH1040F	Guía frontal de aluminio	Regla guía	1	150662-5
LS1220	Guía frontal de aluminio	Regla guía	1	150796-4
LS1016	Guía frontal derecha	Regla guía	1	158969-3
LS1016	Guía frontal izquierda	Regla guía	1	158970-8
LS1016	Kit laser	laser	1	638651-5
2702,2703	Guía para sierras de banco	Regla guía	1	122556-4
2704	Set completo de guía deslizable	Regla guía	1	122740-1
GS6000	Jgo. de cubierta de disco 150K		1	123200-6

Prensas



Usar en	Aplicación	Tipo	Medidas	Empaque Piezas	No. Parte
LS0714	Asegura el material sobre la herramienta	Prensa horizontal		1	122563-7
LS1016	Asegura el material sobre la herramienta	Prensa horizontal		1	122930-6
LS1030N,LS1040,LS1013,LS1220,LS1211	Asegura el material sobre la herramienta	Prensa horizontal	5-1/2"	1	122470-4
LS1030N,LS1040,LS1440	Asegura el material sobre la herramienta	Prensa horizontal	7"	1	122625-1
LS0714	Asegura el material sobre la herramienta	Prensa vertical		1	122571-8
LS1016	Asegura el material sobre la herramienta	Prensa vertical		1	122854-6
LS1030N,LS1040,LS1013,LS1220	Asegura el material sobre la herramienta	Prensa vertical	2-1/4"	1	122536-0
LS1030N,LS1040,LS1013,LS1220	Asegura el material sobre la herramienta	Prensa vertical	2-1/4"	1	192672-6
LS1212/14/F	Asegura el material sobre la herramienta	Prensa vertical		1	122540-9
LS1013	Limita la inclinación de la pieza para uso en corte de molduras	Prensas de inclinación		1	192628-9
LS1045	Limita la inclinación de la pieza para uso en corte de molduras	Prensas de inclinación		1	192622-1
LS1216	Limita la inclinación de la pieza para uso en corte de molduras	Prensas de inclinación		1	195253-5
LS1220	Limita la inclinación de la pieza para uso en corte de molduras	Prensas de inclinación		1	192669-5
	Asegura el material sobre la herramienta	Prensa		1	JM23000182

Extensiones



Usar en	Aplicación	Tipo	Empaque Piezas	No. Parte
LS1030N,LS1040	Apoyo y nivel para barras de extensión	Base para barras de extensión	1	122446-1
LS1030N,LS1040	Apoyo y nivel para barras de extensión	Base para barras de extensión	1	256812-1
LS1220,LS1221	Apoyo y nivel para barras de extensión	Base para barras de extensión	1	192671-8
LS1214	Aseguramiento de la pieza a cortar	Protección derecha	1	153898-5
LS1221	Aumenta el espacio de trabajo p/ apoyo del material	Extensión 160	1	323726-0
LS1016	Aumenta el espacio de trabajo p/ apoyo del material	Extensión de soporte	1	192501-3
2704	Aumenta el espacio de trabajo p/ apoyo del material	Extensión frontal	1	194087-3
2704	Aumenta el espacio de trabajo p/ apoyo del material	Extensión izquierda	1	194086-5
LS1016	Aumenta el espacio de trabajo p/ apoyo del material	Extensión lateral	1	322932-4
LS1016	Aumenta el espacio de trabajo p/ apoyo del material	Extensión lateral	1	325673-1
LS1030N,LS1040	Aumenta el espacio de trabajo p/ apoyo del material	Extensión lateral	1	322312-4
LS1220,LS1221	Aumenta el espacio de trabajo p/ apoyo del material	Extensión lateral	1	192673-4
2702,2703	Aumenta el espacio de trabajo p/ apoyo del material	Mesa complementaria derecha 60x40cm	1	192797-6
2702,2703	Aumenta el espacio de trabajo p/ apoyo del material	Mesa complementaria derecha 60x40cm	1	192798-4

Mesas de trabajo y soportes para sierras

Carro de mano



Descripción	Usar en	No. Parte
Carro de mano	2702, 2703, 2704	194093-8

Mesas de trabajo y soportes para sierras

Mesa de trabajo



* Se puede usar en todas las sierras compuestas, sierras de inglete y mesa de banco

Descripción	No. Parte
Mesa de trabajo para sierra de banco	DEAWST05

Mesa de trabajo plegable



Descripción	Para modelo	No. Parte
Mesa de trabajo plegable con extensión	Todas las sierras de inglete compuesto, sierra de inglete	198687-1

Mesa de trabajo



* Se puede usar en todas las sierras compuestas, sierras de inglete y mesa de banco

Descripción	No. Parte
Mesa de trabajo para sierra de banco, La herramienta se puede colocar y quitar sin llave	DEWST06

Soportes plegables



Descripción	Para modelo	No. Parte
Soporte plegable para sierras de inglete	Todas las sierras de inglete compuesto, sierra de inglete	198688-9

Accesorios para esmeriladoras

Protege al operador contra residuos y despojos de material



Usar en	Medidas	Fijación	Empaque piezas	No. Parte
9561	4-1/2"	Anillo con tornillo	1	135107-4
9524,9527,9551 MGA450,MT952	4-1/2"	Anillo con tornillo	1	165362-4
9524/NB, 9527/NB/PB	4-1/2"	Anillo con tornillo	1	165053-7
9554, 9557NB	4-1/2"	Anillo con tornillo	1	125267-0
GA4534	4-1/2"	Anillo con tornillo	1	122886-3
9565CV, GA5010C	5"	Anillo con tornillo	1	135108-2
9015DB	5"	Tornillo (se vende por separado)	1	165055-3
MGA701	5"	Anillo con tornillo	1	122890-2
9067, 9067L, MGA700	7"	Anillo con tornillo	1	154768-1
GA7020,GA7021	7"	Anillo con tornillo	1	154676-6
GA7050R	7"	Anillo con tornillo	1	122939-8
GA7911	7"	Anillo con tornillo	1	191395-3
MT900,MGA901 LS1212/14/F	9"	Anillo con tornillo	1	122892-8
9069,MGA900, MT901	9"	Tornillo (se vende por separado)	1	154767-3
GA9050R	9"	Anillo con tornillo	1	122938-0
DGA700, GA7020, GA7030, GA7040S	7"	Guarda de cambio rápido 7" para esmeriladoras inalámbricas	1	NUEVO 123542-8
DGA900, GA9020, GA9030, GA9040S	9"	Guarda de cambio rápido 9" para esmeriladoras inalámbricas	1	NUEVO 123543-6
	115mm	Cubierta para esmeriladora	1	NUEVO 199709-0
	125mm	Cubierta para esmeriladora	1	NUEVO 199710-5
Usar en BHR200S		Extractor de polvo	1	193472-7

Guarda recolectora de polvo



Usar en	Descripción	Empaque piezas	No. Parte
Esmeriles de 4-1/2" y 5"	Tapa cubre polvo para disco aplanador de concreto, para Desbaste	1	195236-5
Esmeriles de 4" y 5"	Guarda recolectora de polvo diámetro 125mm para corte	1	196846-1
Esmeriles de 7"	Guarda extractora de polvo de 7" para desbaste	1	195386-6
Esmeriles de 7"	Guarda extractora de polvo de 7" para corte	1	194303-3
Esmeriles de 9"	Guarda extractora de polvo de 9" para corte	1	198511-8

Empuñaduras

Empaque 1pza.



Usar en	Tipo	No. Parte
Todas las mini esmeriladoras de 4 1/2"	Estándar	153489-2
6013BR, 6016,6300-4, 9005B, 9015DB,9218PB/SB,DS4011, DS5000,GA7001/L,GA7911	Estándar	152492-0
GA4030	Estándar	153504-2
Todas las Esmeriladoras de 7" y 9"	Estándar	152539-0
Esmeriladoras GA5010/9020/6020	Anti vibración	194514-0
Esmeriladoras GA5010/9020/6020	Anti vibración	194543-3
Pulidoras PV7001C,GV7000C GV5010C,GV601	Estándar	152491-2
GA5010,CA5011,GA5020, GA5021/C, GA6010, CA6011, GA6020/C,GA6021/C	Agarradera Superior tipo "D"	194483-5
Pulidora 9227C	Agarradera Superior tipo "D"	416256-9

Empuñaduras laterales

Empaque 1pza.

	Usar en	Descripción	No. Parte
	BDF453	Empuñadura lateral	122822-9
	HP2010N	Empuñadura lateral	122428-3
	HR3200C	Empuñadura lateral	135197-7
	HR3540C,HR3541FC, HR4001C, HR4010C, HR4011C,HR4501C, HR4510C,HR4511C	Empuñadura lateral 36	135209-6
	HR4003C, HR4013C	Empuñadura lateral	123138-5
	HR5202C, HR5212C	Empuñadura lateral	135629-4
	HP1230, HP2032,HP2034, HP2040,HP2042, HP2050, HP2010, HR2431,HR2450	Empuñadura lateral	152521-9
	HP1230, HO2050/F, HP2051/F, HP2070/F, HP2071/F, HR2010, HR2020, HR2021,HR2022, HR2432, HR2440/F, HR2441, HR2442, HR2445, HR2450/F/T/FT, HR2451, HR2452, HR2453,HR2454, HR2455	Empuñadura lateral	153503-4
	BHR202,BHR242,BHR243, BHR261, BHR262,HP1230, HR1830/F/FT, HR2230, HR2460/F, HR2470/F/T/FT, HR2475, HR2800,HR2810/FT,HR2811FT	Empuñadura lateral con cubierta de neopreno	158057-6
	HM0870C	Empuñadura lateral	158131-0
	HR3851,HR3850K, HR5000/K, 8406,8406C	Empuñadura lateral 32	273472-4
	HM0870C, HM0871C	Empuñadura lateral completa	135332-7
	HP1631 DHR263	Empuñadura lateral	417630-4

Base para agarradera lateral

Usar en	Descripción	No. Parte
 Base para agarradera lateral	HR4000C,HR4002,HR4510	416299-1

Mango de sujeción



Usar en	Descripción	No. Parte
HR5000	Mango de sujeción completo	134887-9
HM1111C, HR4000C,HR4001C, HR4011C,HR4510C	Mango de sujeción completo	134890-0
HM1100/C, HM1100C, HM1140C, HM1211B	Agarradera lateral p/ rotomartillo	134909-5
HM1202/C, HM1203C, HM1213C, HR5201C, HR5210C, HR5211C	Mango de sujeción completo	135269-8

Paño de limpieza

Usar en	Descripción	Piezas empaque	No. Parte
 HR3851	Paño de limpieza	1	443122-7

Dispositivo recolector de polvo para brocas y cinceles

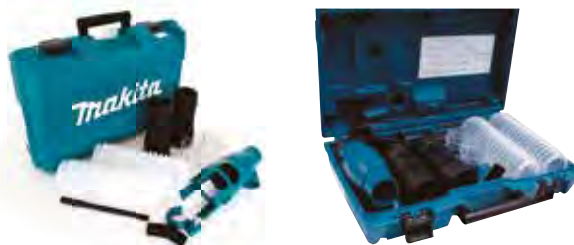

Usar en	Descripción	No. Parte
HR5202C, HR5212C	Extractor de polvo	196858-4
HR4011C	Extractor de polvo	196074-8

Recolector de polvo p/ sierra de inglete

Descripción	Para modelo	No. Parte
 Recolector de polvo p/ LS1016 / LS1216	LS1016/ LS1216	194175-6

Dispositivo recolector de polvo para HM1812



Usar en	Descripción	No. Parte
 HM1812	Extractor de polvo con manguera	197148-8*
HM1812	Extractor de polvo	197168-2

*Con manguera

Sistema de extracción de polvo

Usar en	Descripción	Piezas Empaque	No. Parte
 DHR242	Sistema de extracción de polvo (DX01)	1 sistema	195896-3
DHR282	Sistema de extracción de polvo (DX08)	1 sistema	199556-9
DHR281 / DHR283	Sistema de extracción de polvo (DX09)	1 sistema	199558-5

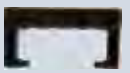
Complementos para sierras circulares

Usar en	Aplicación	Tipo	No. Parte
 LS1220	Adaptación para extracción de polvo	Codo direccional	416368-8
 5007NB	Apoyo para cortes más precisos	Mango para sierra circular	419360-3
LS0714	Protección al usuario contra expulsión de residuos	Complemento de guarda protectora	122472-0
 2702	Protección al usuario contra expulsión de residuos	Guarda	168313-6

Filtros de protección

Protección de la herramienta contra residuos al interior del motor



Usar en	Fijación	Empaque piezas	No. Parte
9561 /62/63/64/65/66	A presión sobre las rendijas de ventilación	Juego 2 piezas	193903-6
GA7010/9010	A presión sobre las rendijas de ventilación	Juego 2 piezas	193956-5
GA7020/30/40, GA9020/30/40	A presión sobre las rendijas de ventilación	Juego 2 piezas	194289-1
9564PVC,9565PCV, 9566PCV	A presión sobre las rendijas de ventilación	Juego 2 piezas	195446-4
9564CVL,9565CVL, 9565CLR,PW5000C, PW5001C	A presión sobre las rendijas de ventilación	Juego 2 piezas	417322-5

Mango de extensión para DTR180



NUEVO

No. Parte 191M27-0

Adaptador de nariz para DBN500



NUEVO

No. Parte 424121-8

Barril de grasa para DGP180









Diseñado en metal resistente para evitar daños accidentales

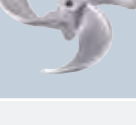

NUEVO

Descripción	No. Parte
Barril A 410gr. Cartucho /455gr Granel	327379-7
Barril B 450gr. Cartucho /570gr Granel	327380-2

Accesorios para mezclador de concreto

	Usar en	Aplicación	Barra de eje	Tipo	Fabricación	Medidas (diám-eje)	Tornillo	Empaque Pieza	No. Parte
	UT1305 (1300 Rpm)	Mezclas de baja densidad (pinturas vinílicas, esmaltes, solventes)	A43751 acero inoxidable, rosca interna	Disco 130	Acero inoxidable	5" x 1/4"	2652205 M8 x 18	1	A-43670
	UT1305 (1300 Rpm)	Mezclas de baja densidad (pinturas vinílicas, esmaltes, solventes)	A43751 acero inoxidable, rosca interna	Disco 150	Acero inoxidable	6" x 1/4"	2516865 M8 x 25	1	A-43686
	UT1305 (1300 Rpm)	Mezclas de baja densidad (pinturas vinílicas, esmaltes, solventes)	A43751 acero inoxidable, rosca interna	Disco 165	Acero inoxidable	6 x 1/4"	2652205 M8 x 18	1	A-43692
	UT2204 (550 rpm)	Mezclas de alta densidad (pastas texturizadas,yesos, mezclas cementadas)	A43773 acero inoxidable vastago liso	Helice 175	Aluminio	7" x 3/8" Int. Liso	2654752 W5/16 x 16	1	A-43701
	UT2204 (550 rpm)	Mezclas de alta densidad (pastas texturizadas,yesos, mezclas cementadas)	A43773 acero inoxidable vastago liso	Helice 190	Acero tropicalizado	7-1/2" x 3/8" Int. Liso	2654752 W5/16 x 16	1	A-33065
	UT2204 (550 rpm)	Mezclas de alta densidad (pastas texturizadas,yesos, mezclas cementadas)	A43773 acero inoxidable vastago liso	Helice 220	Aluminio	9" x 3/8" Int. Liso	2654401 M8 x 16	1	A-43717
	UT2204 (550 rpm)	Mezclas de alta densidad (pastas texturizadas,yesos, mezclas cementadas)	A43773 acero inoxidable vastago liso	Helice 135	Aluminio	5-1/4" x 3/8" Int. Liso	2654752 W5/16 x 16	1	A-43723
	UT2204 (550 rpm)	Mezclas de alta densidad (pastas texturizadas,yesos, mezclas cementadas)	A43773 acero inoxidable vastago liso	Helice 183	Aluminio	7" x 3/8" Int. Liso	2654752 W5/16 x 16	1	A-43739
	UT2204 (550 Rpm)	Mezclas de alta densidad (pastas texturizadas,yesos, mezclas cementadas)	A43773 acero inoxidable vastago liso	Helice 201	Acero tropicalizado	8" x 3/8" Int. liso	2654752 W5/16x16	1	A-33071

Aspa para mezclador



Para líquidos

Para materiales de alta densidad

Para material de secado rápido

NUEVO

Descripción	Diámetro de la paleta y longitud	Zanco	Empaque Pieza	No. Parte
Aspa mezcladora para líquidos acción de mezclado hacia abajo 2 paletas	120mm x 600mm	M14	1	D-73508
Aspa mezcladora para material de alta densidad / 2 paletas Acción de mezclado hacia arriba	120mm x 600mm	M14	1	D-73514
Aspa mezcladora para material de secado rápido / 3 paletas Acción de mezclado hacia abajo	120mm x 600mm	M14	1	D-73520
Aspa mezcladora para líquidos Acción de mezclado hacia abajo / 2 paletas	120mm x 600mm	Hex 3/8"	1	D-73536
Aspa mezcladora para material de alta densidad / 2 paletas Acción de mezclado hacia arriba	120mm x 600mm	Hex 3/8"	1	D-73542

Ejes para mezclador



Usar en	Fabricación	Medidas (diámetro-eje)	Tornillo	Empaque Pieza	No. Parte
UT1305	Acero inoxidable	3/8" x 23" Rosca interna	Vea especificaciones del acceso mezclador	1	168349-5
UT2204	Acero inoxidable	3/8" x 23" Vastago liso	Vea especificaciones del acceso mezclador	1	A-43773
UT2204	Acero al carbón	3/8" x 21" Rosca exterior	Vea especificaciones del acceso mezclador	1	A-43795

Chicotes flexibles para Vibrador de concreto VR1000



Descripción	Longitud (M)	Empaque pieza	No. Parte
Chicote flexible p/ VR1000	1.5m	1	198700-5
Chicote flexible p/ VR1000	3.5m	1	198701-3
Chicote flexible p/ VR1000	4.5m	1	198702-1

Accesorios para pistolas térmicas

Boquillas para HG5030, HG6030, HG6031V, HG6530V, HG6531C

NUEVO





	Tipo	Aplicación	Medidas	Usar en	Empaque Pieza	No. Parte
	Boquilla angular	Boquilla para protección de vidrio		HG5030 HG6030 HG6031V HG6530V HG6531C	1	PR00000028
	Boquilla de ranura ancha			HG5030 HG6030 HG6031V HG6530V HG6531C	1	PR00000029
	Boquilla reflectora			HG5030 HG6030 HG6031V HG6530V HG6531C	1	PR00000030
	Boquilla de reducción 20mm			HG5030 HG6030 HG6031V HG6530V HG6531C	1	PR00000031
	Boquilla de soldadura superpuesta			HG5030 HG6030 HG6031V HG6530V HG6531C	1	PR00000032
	Boquilla reflectora de soldadura			HG5030 HG6030 HG6031V HG6530V HG6531C	1	PR00000033
	Boquilla de soldadura	Flujo concentrado de aire, para derretir barras de soldadura de plástico o uniones de piezas plásticas		HG5030 HG6030 HG6031V HG6530V HG6531C	1	PR00000034
	Boquilla de soldadura rápida			HG5030 HG6030 HG6031V HG6530V HG6531C	1	PR00000039

Accesorios para pistolas térmicas

Boquillas

Tipo	Aplicación	Medidas	Usar en	Empaque Pieza	No. Parte
	Flujo de aire para calefacción de grandes superficies	3" X 1/4"	HG1100	1	110702-A
	Flujo de aire en superficies pequeñas, adaptable con 110720A para soldadura de plástico.	3/8"	HG1100	1	110706-A
	Para adaptar con 110720A, flujo concentrado de aire para derretir barras de soldadura plástica o unión de piezas plásticas.	3/4"	HG1100	1	110720-A
	Para deflectar el flujo de aire alrededor de superficies tubulares, para doblar tubo PVC, materiales plásticos, descongelar tuberías y soldar cobre.	3"	HG1100	1	110730-A
	Flujo de aire en superficies angostas, nariz angular para dirección de flujo de aire, para soldar materiales de PVC, lozeta asfaltada en techos, entre otras aplicaciones	1-3/4" x 3/16"	HG1100	1	110751-A
	Boquilla para protección de vidrio		HG5002, HG5012	1	P-71417
	Deflector soldador de cubiertas		HG651C	1	P-71495
	Para calentamiento de grandes superficies y sellado de micas adhesivas.		HG5002, HG5012	1	P-71423

Soldaduras

Tipo y aplicación	Medidas	Usar en	Empaque Pieza	No. Parte
 Soldadura ABS Para operaciones de soldado y relleno en materiales plásticos. (Asegure que el tipo de soldadura sea compatible con el material a soldar).	9" x 1/8"	HG1100, HG5002	Bolsa 100gr. (25 Pzs.)	110742-A
 Soldadura ABS (Termo plástico)	9" x 1/8"	HG5030, HG6030, HG6031V, HG6530V, HG6531C	Pzs	PR00000036
 Soldadura ABS (Termo plástico)	9" x 1/8"	HG5030, HG6030, HG6031V, HG6530V, HG6531C	Pzs	PR00000037
 Soldadura ABS (Termo plástico)	9" x 1/8"	HG5030, HG6030, HG6031V, HG6530V, HG6531C	Pzs	PR00000038

Rodillos / espátulas

Tipo	Aplicación	Medidas	Usar en	Empaque Pieza	No. Parte
	Para estiramiento, sellado o parchado de lonas vinílicas y tapices.	1-1/2" Diámetro x 1-1/4" ancho	Todos	1	P-71504
		2"	Todos	1	P-71548
		Triangular plana redonda	Todos	1	P-71554
 NUEVO			HG5030, HG6030, HG6031V, HG6530V, HG6531C	1	PR00000035
 NUEVO			HG5030, HG6030, HG6031V, HG6530V, HG6531C	1	PR00000040
 NUEVO			HG5030, HG6030, HG6031V, HG6530V, HG6531C	1	PR00000042
 NUEVO			HG5030, HG6030, HG6031V, HG6530V, HG6531C	1	PR00000041

Accesorios para Hidrolavadoras

HW1200 / HW1300 / DHW080

NUEVO

Mangueras

	Descripción	Empaque Pieza	No. Parte
	Manguera de alta presión (10mts) para HW1200 / DHW080	1	123784-4
	Manguera para limpieza de tuberías (10mts) para HW1200 / HW1300 / DHW080	1	197837-5
	Manguera para limpieza de tuberías (15mts) para HW1200 / HW1300 / DHW080	1	197840-6
	Manguera de alta presión (5mts) para DHW080 / HW1200 / HW1300	1	197845-6
	Manguera de alta presión (8mts) para HW1200 / HW1300 / DHW080	1	197847-2
	Manguera de alta presión (10mts) para HW1200 / HW1300 / DHW080	1	197850-3
	Manguera de auto succión para HW1200 / HW1300 / DHW080	1	197873-1
	Manguera de alta presión (10mts) para HW1300	1	TG00000009
	Manguera de alta presión (5mts) para DHW080	1	126766-5



Accesorios para Hidrolavadoras

HW1200 / HW1300 / DHW080

NUEVO

Lancetas

	Descripción	Empaque Pieza	No. Parte
	Lanceta de rocío vertical para DHW080 / HW1200 / HW1300	1	197859-5
	Lanza metálica para HW1200	1	123643-2
	Lanceta de pulverización variable para DHW080 / HW1200 / HW1300	1	197822-8
	Lanceta giratoria de rocío variable para DHW080 / HW1200 / HW1300	1	197876-5
	Pistola para hidrolavadora para DHW080 / HW1200 / HW1300	1	197842-2
	Set de lanceta ciclón jet para DHW080 / HW1200 / HW1300	1	197824-4
	Set de lanza espuma para DHW080 / HW1200 / HW1300	1	197886-2



Accesorios para Hidrolavadoras

HW1200 / HW1300 / DHW080

NUEVO

Cepillos y conectores



	Descripción	Empaque Pieza	No. Parte
	Cople de fácil unión para DHW080 / HW1200 / HW1300	1	197883-8
	Cople adaptador para DHW080 / HW1200 / HW1300	1	197853-7
	Conector entrada rápida para DHW080 / HW1200 / HW1300	1	197867-6
	Conector de absorción para DHW080 / HW1200 / HW1300	1	197881-2
	Set de tubos de extensión para DHW080 / HW1200 / HW1300	1	197870-7
	Alfiler de limpieza para DHW080 / HW1200 / HW1300	1	197879-9
	Cepillo antisplacaduras para DHW080 / HW1200 / HW1300	1	197864-2
	Cepillo de limpieza para DHW080 / HW1200 / HW1300	1	197828-6
	Cepillo de rotación para DHW080 / HW1200 / HW1300	1	197831-7
	Junta para manguera de alta presión para HW1300	1	TG00000004
	Set conector para DHW080 / HW1300	1	197810-5
	Maletín de plástico para DHW080	1	127104-4



Equipo de seguridad

Para protección del usuario durante el uso de herramientas

Guantes de trabajo



	Descripción	Talla	Empaque Pieza	No. Parte
	Guante profesional de carnaza para esmeriladoras	L	Par	988000909
	Guante profesional de carnaza para esmeriladoras	XL	Par	988000910
	Guante profesional de carnaza para esmeriladoras	XXL	Par	988000911
	Guante universal acabado textil	L	Par	988000710
NUEVO 	Guante profesional "DEMOLITION serie"	M	Par	88-1-MK103-M
	Guante profesional "DEMOLITION serie"	L	Par	88-1-MK103-L
	Guante profesional "DEMOLITION serie"	XL	Par	88-1-MK103-XL

Lentes de seguridad

Equipo de seguridad para protección durante el uso de herramientas

	Descripción	Talla	Empaque Pieza	No. Parte
	Lentes de seguridad para protección ocular	Universal	Pieza	T-02456 Humo
	Lentes de seguridad para protección ocular	Universal	Pieza	T-02559 Verde
	Lentes de seguridad para protección ocular	Universal	Pieza	T-02543 Ámbar
	Lentes de seguridad para protección ocular	Universal	Pieza	T-02462 Transparente

Cajas para herramientas Makita

	Descripción	Empaque pieza	No. Parte
	Caja de herramientas 16" plástica	1	7167
	Caja de herramientas 20" plástica	1	7165
	Caja de herramientas 24" plástica (cerradura metálica)	1	7685

Blue Collection

Fundas Portaherramientas

Accesibilidad a los equipos de trabajo

	Descripción	Empaque pieza	No. Parte
	Porta martillo lateral	1	P-71875
	Porta herramienta y navaja	1	P-71928
	Funda portaherramienta a batería	1	P-80880
	Funda porta smartphone	1	P-80896
	Funda p/ atornillador tipo lápiz para DF010D - TD020D - TD021D	1	P-80999
	Organizador de accesorios c/cordón de seguridad	1	P-80874
	Correa azul para hombro y cintura c/ broche	1	P-81000
	Funda porta cámara o celular grande	1	P-71853
	Portaherramienta para instaladores c/porta martillo profesional	1	P-81343
	Porta clavos c/soporte para martillos	1	P-81480
	Porta pijas c/soporte para martillos profesional	1	P-81371
	Funda para herramienta Usar en BDF330D	1	168467-9

Cinturones

Accesibilidad a los equipos de trabajo

	Descripción	Empaque pieza	No. Parte
	Cinturón de piel Uso pesado	1	P-71803
	Cinturón para herramientas pesadas	1	P-71819
	Cinturón c/ portapinzas y porta desarmadores plegable	1	P-80905
	Cinturón c/ 4 compartimentos profesional	1	P-81474
	Rodilleras de gel para uso industrial	1	P-71978

Mochila profesional para herramientas inalámbricas P-72017



Gran capacidad para almacenar y organizar herramientas



Variedad de compartimentos para organizar piezas de diversos tamaños. Compartimentos con cierres para mayor seguridad.



Espalda acolchonada hecha de malla 3D, material que brinda máxima comodidad.

Bolsillos en los costados, hechos de malla con banda elástica que evita que las herramientas se caigan.



Cómoda alternativa para llevar tus herramientas a donde sea.

Maletas para herramientas inalámbricas

Accesibilidad a los equipos de trabajo

	Descripción	Empaque pieza	No. Parte
	Maleta para herramientas y accesorios c/ asa	1	P-80949
	Maleta para herramientas y accesorios repelente al agua	1	P-79946
	Mochila profesional para herramientas, con organizador	1	P-72017

Maletas Makita para herramientas inalámbricas

	Descripción	Empaque pieza	No. Parte
	Maleta para herramientas inalámbricas	1	831271-6
	Maleta para herramientas inalámbricas color verde	1	831278-2
	Maleta para herramientas inalámbricas color verde con ruedas	1	831279-0
	Maleta para herramientas inalámbricas color negro	1	832069-4
	Maleta para herramientas inalámbricas color negro	1	832072-5
	Maleta para herramientas inalámbricas color verde	1	832035-1
	Maleta para herramientas inalámbricas color verde	1	832071-7



ACCESORIOS PARA ASPIRADORAS

SOLUCIONES EN LIMPIEZA



+ Confort - Quejas

 + **descanso** =  + **ganancia**

Haga más cómoda la estancia de los huéspedes utilizando la variedad de equipos en **SOLUCIONES DE LIMPIEZA**. Con la variedad de aspiradoras Makita se puede cubrir áreas más grandes, limpiar en diferentes espacios y aumentar la eficiencia, pero lo más importante, limpiar **SIN CABLES**, con una calidad y un rendimiento insuperables. Los productos **inalámbricos LXT® y CXT®** de Makita reducen el costo y el mantenimiento proporcionando una solución para cada aplicación.

AWS
Sistema de Auto-Encendido Inalámbrico



SISTEMA DE AUTO ENCENDIDO INALÁMBRICO

Sistema de encendido inalámbrico automático, utiliza la tecnología Bluetooth® para comunicación inalámbrica de encendido / apagado entre la herramienta y la aspiradora.





ASPIRADORA VERTICAL ASPIRADORAS DE MOCHILA ASPIRADORAS DE PISO ASPIRADORAS HÍBRIDAS ASPIRADORAS PORTÁTILES ASPIRADORA ROBÓTICA ASPIRADORAS DE MANO SOPLADORAS

*Identifique los modelos con tecnología AWS a través del icono de la tecnología.

CEPILLOS

DESCRIPCIÓN	APLICACIÓN	USAR EN:	EMPAQUE PIEZAS	NO. DE PARTE	
	Cepillo largo	Limpieza de alfombras	407	1	743328-0
	Cepillo aspirador (ivory)	Estanterías	407ID	1	191724-0
	Cepillo aspirador	Limpieza de alfombras	4073D, 4093D	1	122520-5
	Cepillo aspirador	Limpieza de alfombras	BCL140	1	122859-6
	Cepillo aspirador	Limpieza de alfombras	Todas las aspiradoras	1	122291-4
	Cepillo redondo	Limpieza de muebles	Todas las aspiradoras	1	198548-5
	Cepillo aspirador (blanco)	Limpieza de maletero de avión o autobús, televisión	Aspiradora de mano DC Aspiradora tipo mochila DC	1	198878-4
	Cepillo aspirador (ivory)	Limpieza de maletero de avión o autobús, televisión	Aspiradora de mano DC Aspiradora tipo mochila DC	1	198552-4
	Cepillo aspirador (rosa)	Limpieza de maletero de avión o autobús, televisión	Aspiradora de mano DC Aspiradora tipo mochila DC	1	198880-7
	Cepillo aspirador (negro)	Limpieza de maletero de avión o autobús, televisión	Aspiradora de mano DC Aspiradora tipo mochila DC	1	198555-8
	Cepillo aspirador (azul)	Limpieza de maletero de avión o autobús, televisión	Aspiradora de mano DC Aspiradora tipo mochila DC	1	198549-3
	Escobilla redonda	Limpieza de muebles	Varios	1	191657-9
	Cepillo aspirador (blanco)	Limpieza de soportes y estantes de TV	Aspiradora de mano DC Aspiradora tipo mochila DC	1	198873-4
	Cepillo aspirador (azul)	Limpieza de soportes y estantes de TV	Aspiradora de mano DC Aspiradora tipo mochila DC	1	198534-6
	Cepillo aspirador (rosa)	Limpieza de soportes y estantes de TV	Aspiradora de mano DC Aspiradora tipo mochila DC	1	198875-0
	Cepillo aspirador 260mm		VC2512L	1	W107402706
	Cepillos laterales		DRC200	2	SH0000065
	Cepillo		DRC200	1	SH00000313
	Cepillo	Limpieza en lugares profundos y en el coche	CL121	1	140H94-2

TUBOS Y CONECTORES

DESCRIPCIÓN	APLICACIÓN	USAR EN:	EMPAQUE PIEZAS	NO. DE PARTE	
	Broche conector	Para ensamble	407	1	256241-8
	Soportes para manguera	Para ensamble	VC1310L, VC2510L, VC3210L	1	195544-4
	Codo de plástico blanco	Para ensamble	VC1310L, VC2510L, VC3210L	1	154427-7

DESCRIPCIÓN	APLICACIÓN	USAR EN:	EMPAQUE PIEZAS	NO. DE PARTE	
	Conector frontal 22	Para ensamble	BVC340, BVC350, VC1310L, VC2510L, VC3210	1	195547-8
	Conector frontal 24	Para ensamble	BVC340, BVC350, VC1310L, VC2510L, VC3210	1	195546-0
	Conector frontal 38	Para ensamble	BVC340, BVC350, VC1310L, VC2510L, VC3210	1	195545-2
	Junta 22-38	Para ensamble	VC1310L, VC2510L, VC3210L	1	195548-6
	Ducto conector	Para ensamble	VC1310L, VC2510L, VC3210L	1	415946-1
	Ensamble de tubo curvo	Para ensamble		1	126756-8
	Tubo curvo	Para ensamble	VC1310L, VC2510L, VC3210L	1	192562-3
	Tubo recto	Para ensamble	VC1310L, VC2510L, VC3210L	1	192563-1
	Tubo recto		DVC260, DVC261, DCL180, DCL281	1	198559-0
	Tubo flexible (ivory)	Para ensamble	Todas las aspiradoras	1	191496-7
	Manguera corrugada	Para ensamble		1	193326-8
	Manguera corrugada 28mm, 3.5m.	Para ensamble	VC1310L, VC2510L, VC3210L	1	195433-3
	Manguera corrugada 28mm, 5m.	Para ensamble	VC1310L, VC2510L, VC3210L	1	195436-7
	Manguera anti-estática de 1-3/8"x16'	Previene la acumulación de polvo y shock estático	VC4710L	1	P-79865
	Tubo de aspirado color negro 35x20mm		VC2512L	2	P-72942
	Manguera de aspirado con tubo de mano 32x3.5mm		VC2512L	1	P-81739
	Manguera de 38mm		VC3210L	1	195434-1
	Manguera		DVC759L	1	140G04-3
	Adaptador con regulador		VC2512L	1	P-81745
	Boquilla flexible (blanco)			1	198867-9
	Boquilla flexible (azul)			1	198541-9
	Boquilla flexible (negro)			1	198543-5

El equipo estándar (accesorios), las especificaciones y las fotografías pueden variar. Los accesorios pueden no estar incluidos desde origen con las herramientas, aunque se indiquen en este catálogo.

BOQUILLAS

DESCRIPCIÓN	APLICACIÓN	USAR EN:	EMPAQUE PIEZAS	NO. DE PARTE
Boquilla para pisos 12"	Limpieza de residuos en piso	407	1	122512-4
Boquilla para pisos seco/mojado	Limpieza de residuos en piso	VC1310L, VC2510L, VC3210L, VC6211H	1	195551-7
Boquilla para alfombra (blanca).	Limpieza en suelo o alfombra	Aspiradora de mano DC Aspiradora tipo mochila DC	1	198183-9
Boquilla para alfombra (azul).	Limpieza en suelo o alfombra	Aspiradora de mano DC Aspiradora tipo mochila DC	1	199431-9
Boquilla para alfombra (blanca).	Limpieza, debajo del sofá, piso y alfombra	Aspiradora de mano DC Aspiradora tipo mochila DC	1	198525-7
Boquilla para alfombra (ivory).	Limpieza, debajo del sofá, piso y alfombra	Aspiradora de mano DC Aspiradora tipo mochila DC	1	198150-4
Boquilla para alfombra (rosa).	Limpieza, debajo del sofá, piso y alfombra	Aspiradora de mano DC Aspiradora tipo mochila DC	1	198882-3
Boquilla para alfombra (negra).	Limpieza, debajo del sofá, piso y alfombra	Aspiradora de mano DC Aspiradora tipo mochila DC	1	198526-5
Boquilla para alfombra (azul).	Limpieza de maletero de avión o autobús, televisión	Aspiradora de mano DC Aspiradora tipo mochila DC	1	198523-1
Boquilla tipo T (blanca)	Limpieza de asientos de coches, cines.	Aspiradora de mano DC Aspiradora tipo mochila DC	1	199037-3
Boquilla tipo T (azul)	Limpieza de asientos de coches, cines.	Aspiradora de mano DC Aspiradora tipo mochila DC	1	199040-4
Boquilla tipo T (negro)	Limpieza de asientos de coches, cines.	Aspiradora de mano DC Aspiradora tipo mochila DC	1	198921-9
Boquilla de piso tipo T	Limpieza de asientos de coches, cines.	Aspiradora de mano DC Aspiradora tipo mochila DC CL121	1	140H95-0
Boquilla tipo T	Limpieza de asientos de coches, alfombra.	Aspiradora de mano DC Aspiradora tipo mochila DC CL121	1	459056-4
Boquilla para rincones 33cm	Limpieza en lugares de difícil acceso	407	1	410306-2
Boquilla superior	Ensamble	407	1	415965-7
Boquilla tapicera		DVC750	1	458891-7
Juego de aspiración	Limpieza en lugares de difícil acceso	UB121D, UB141D, UB181D, BUB142, BUB182	1	191750-9
Boquilla angosta	Limpieza en lugares de difícil acceso	UB121D, UB141D, UB181D, BUB142, BUB182, BVC340, BVC350, XBV01B	1	192236-6
Boquilla 220mm	Dirección del flujo de aire	UB1101 DVC350	1	132025-7
Boquilla 430mm	Dirección del flujo de aire	4014NV DVC350	1	134182-7
Boquilla esquinera	Construcción de plástico durable	VC4710L	1	W6084
Boquilla universal		VC2512L	1	W14295

DESCRIPCIÓN	APLICACIÓN	USAR EN:	EMPAQUE PIEZAS	NO. DE PARTE
Boquilla universal		VC2512L	1	W29541
Boquilla 330mm (blanca)	Limpieza de lugares de difícil acceso, espacio de la mesa	Aspiradora de mano DC Aspiradora tipo mochila DC	1	198918-8
Boquilla 330mm (azul)	Limpieza de lugares de difícil acceso, espacio de la mesa	Aspiradora de mano DC Aspiradora tipo mochila DC	1	198989-5
Boquilla 330mm (negra)	Limpieza de lugares de difícil acceso, espacio de la mesa	Aspiradora de mano DC Aspiradora tipo mochila DC	1	198991-8
Boquilla (ivory)	Limpieza en lugares estrechos y de difícil acceso, esquinas, marcos	CL107D CL100D	1	416041-0
Boquilla (blanca)	Limpieza en lugares estrechos, esquinas	Aspiradora de mano DC Aspiradora tipo mochila DC	1	451240-7
Boquilla (azul)	Limpieza en lugares estrechos, esquinas	Aspiradora de mano DC Aspiradora tipo mochila DC	1	451243-1
Boquilla (rosa)	Limpieza en lugares estrechos, esquinas	Aspiradora de mano DC Aspiradora tipo mochila DC	1	457228-5
Boquilla (negra)	Limpieza en lugares estrechos, esquinas	Aspiradora de mano DC Aspiradora tipo mochila DC	1	456586-6
Boquilla para hendiduras 415mm	Limpieza en lugares estrechos, esquinas	Aspiradora de mano DC Aspiradora tipo mochila DC	1	199439-3
Boquilla	Limpieza en lugares profundos y en el coche	CL121	1	422437-5
Boquilla	Limpieza en el automóvil, estantes	CL121	1	140J64-3
Boquilla esquinera		DVC750	1	458919-1

FILTROS

DESCRIPCIÓN	APLICACIÓN	USAR EN:	EMPAQUE PIEZAS	NO. DE PARTE
Pre filtro	Para protección del motor	CL070D, CL100D	1	451208-3
Filtro de tela para polvo	Para protección del motor	BCL140, BCL180	1	443060-3
Filtro de papel polvo	Para protección del motor	BCL182, BCL142, CL102D, CL072D, 4073D, 4093D, 4076D	5	194566-1
Pre-filtro de tela	Para protección del motor	VC1310L	1	195553-3
Pre-filtro de tela	Para protección del motor	VC2510L	1	195554-1
Pre-filtro	Para protección del motor	VC3210L	1	195612-3
Filtro de polvo	Para protección del motor	VC1310L	1	195438-3

FILTROS

DESCRIPCIÓN	APLICACIÓN	USAR EN:	EMPAQUE PIEZAS	NO. DE PARTE
	Para protección del motor	VC2510L	1	195441-4
	Para protección del motor	VC1310L	1	195555-9
	Para protección del motor	VC3210L	1	195611-5
		DCL182Z	1	198746-1
		DCL182Z	1	198748-7
		CL100DZ, DCL180Z, DCL182Z, DCL180Z	1	198752-6
	Para la recolección de polvo y residuos	VC4710L	5	P-78293
		VC4710L	2	P-79843
		VC4710L	2	P-79859
		VC2512L	1	P-72899
	Para la recolección de polvo y residuos	DVC260	10	197903-8
	Para la recolección de polvo y residuos	DVC350	1	122918-6
		DVC665	1	191C26-2
		DVC260, DVC261, DVC265	1	127725-2
		DRC200	1	SH00000213
		DCL180ZB	1	422268-2
		DVC750	1	199827-4
		DVC750	1	162518-0
		DCL281F	1	199966-0
		DVC750	1	191M39-3

DESCRIPCIÓN / APLICACIÓN	USAR EN:	EMPAQUE PIEZAS	NO. DE PARTE
		1	195432-5
	VC3210L, VC1310L, VC2510L	1	195552-5
	VC2512L	5	P-70297
	VC2512L	1	P-70219

REPUESTO PARA BOQUILLA 12"

DESCRIPCIÓN	APLICACIÓN	USAR EN:	EMPAQUE PIEZAS	NO. DE PARTE
	Piezas de repuesto	407	1	743327-2
	Piezas de repuesto	407	1	415962-3
	Piezas de repuesto	407	1	151449-8

OTROS

DESCRIPCIÓN / APLICACIÓN	USAR EN:	EMPAQUE PIEZAS	NO. DE PARTE	
	DRC200	1	SH00000240	
	DCL281F	1	191D71-3	
	Aspiradoras LXTy CXT	1	191D75-5	
	Aspiradoras LXTy CXT	1	199491-1	
	DVC750	1	162523-7	
	DVC665	1	166116-2	
	Para ensamble de estuches Makpac y aspiradoras	1	198730-6	
	Permite conectar la aspiradora y la herramienta via bluetooth para que está encienda automáticamente al encender la herramienta	Herramientas con tecnología AWS	1	198901-5

El equipo estándar (accesorios), las especificaciones y las fotografías pueden variar. Los accesorios pueden no estar incluidos desde origen con las herramientas, aunque se indiquen en este catálogo.

Makita

ACCESORIOS

Accesorio Ciclónico

Para Aspiradora de mano 18V LXT

Este accesorio ciclónico permite un **80% menos** de limpieza en el filtro principal de la aspiradora, alargando su vida útil.

Atrapa las partículas gruesas de polvo y separa las finas por fuerza centrífuga



Video
Accesorio
ciclónico



Mantiene la
potencia de
succión hasta un

90%



VENTAJAS



El sistema previo de separación ciclónica separa el polvo del aire.



Depósito
para polvo

Fácil eliminación de polvo fino recolectado en el depósito.



Pre-filtro No. Parte 198750-0

El set principal de limpieza requiere una eliminación del polvo 80% menos frecuente.

Accesorios Ciclónicos*

Accesorio ciclónico con click

No. Parte 191D71-3



Peso **0.36kg**

Para aspiradoras
DCL281

Capacidad
de polvo **400mL**

Accesorio ciclónico sin click

No. Parte 191D75-5



Peso **0.35kg**

Para aspiradoras
DCL180, CL108FD, CL106FD

Capacidad
de polvo **400mL**

Accesorio ciclónico sin click

No. Parte 199491-1



Peso **0.35kg**

Para aspiradoras
DCL180, CL108FD, CL106FD

Capacidad
de polvo **400mL**

Aspiradoras compatibles



DCL281

DCL180B

CL108FD

*Ninguno de estos accesorios vienen incluidos con las aspiradoras, se venden por separado



JUEGOS DE SERVICIO Y CARBONES

Escobillas de carbón Juego de 2 piezas



CB No.	Para modelo	Tipo	No. Parte
-	G3501R		2097055108
-			181503-4
-	SJ401		375009-000
-	HB500		EIB106C
-	LH1200FL		JM23000123
CB-1	903		181019-9
CB-51	4014N		194963-1
CB-64	6413		194968-1
CB-70	4320, 6501, 9036, 9514B		194970-4
CB-75	3706,4322,4323,4324,4326,4327,4328, 6405 646, 6410, 6413,6510LVR, 6802BV,8416,9035 BO3700, BO3710,BO4510,BO4551,BO4552 BO4562, BO5010, BO5020, BO5021, BO5041 GE0600, GV5000, HP1351,HP1630, JR3000V JV0600,LM2300, LM2850,MBO370,MBO372 MDP200,MDP202, MDP203,MDP300, MDP303 MHP130, MHP131, MHP160,MHP161,MJV430, MT400 MT601, MT650, MT811, MUB101, MUB102		194971-2
CB-76	1900B, 1902, 3700B, 4300BV, 6013BR, 6016, 63004, 6905B, 8422B, 906H, 9803, DA3000R,JN1600, JS1600, JS1660		194972-0
CB-100	4014N		194974-6
CB-105	HK1810, HM0810B, HR2010, HR2511, HR3520	Auto desconexión	194975-4
CB-106	6301, UT0301		194976-2
CB-107	1912B, 3606, 3621,6401,HP2010N, RP0900		194977-0
CB-124	1100, 1600, 2106, 6906, 9005B, 9045B, 9045N, 9207SPB, 92185B, 9741, 9901,9924DB,JN3200, JS3200, PC1100		194982-7
CB-132	UC3020A, UC3520A, UC4020A		194984-3
CB-153			194985-1
CB-154	1805N, 2012, 2012NB, 2702, 2703, 2704, 3601B, 4110C 5007MG, 5007N, 5007NH, 5007NL, 5008MG, 5012B 5014B, 5037NB,5057KB, 5201NA, 5277B, 5377MG 5477NB, 5900B, 6910, 7104L, 9105, 9401, GA7001 GA7001L, GA7911, GC5000, LF1000, LH1040F, LS1013 LS1016, LS1030N, LS1440, MBS400, MBS401, MT940 N5900B, TW1000		194986-9
CB-155	5007NB, 5008NB, HM1202, HM1202C, HM1211B HR3851, HR5000, HR5001C	Auto desconexión	194987-7
CB-175	HM1111C, HM1203C, HM1213C, HM1307CB, HM1317CB HR4510C, HR5201C, HR5210C, HR5211C		195845-0
CB-203	2414NB, 3612/C, KP312, LC1210, LC1230, LS1211 MLC140, MLC141, MRP100, MRP101, MT240, MT360 RP1800, RP1801F, RP2301FC		194991-6

Escobillas de carbón Juego de 2 piezas



CB No.	Para modelo	Tipo	No. Parte
CB-204	9047, 9049, 9067/L, 9069, 9079, 9079, 9617, GA7020 GA7021, GA7050, GA9010C, GA9020, GA9030, GA9040S GA9050/R, HM1303/B, HM1304B, HM1500B, HM1800 HM1801, HM1810, MGA700, MGA701, MGA900 MGA901, MT901, PK5011C, SA7000, SA7000C	Auto desconexión	194992-4
CB-210	4112H		194993-2
CB-253	GA5021, PC5000C, PC5001C, SC161		194994-0
CB-303	2107F, 4100NH, 4100NS, 4130, 4131, 4140, 4200NH, 5740NB, 6924N, 9015DB, 9227C, 9403, 9404, 9902,9903, 9920, 9921, DA4000LR, DA4031, GA5010, GV7000, JR3030, JR3050T, JR3060T		194996-6
CB-304	HM0860C, HM1100/C, HM1140C, HR3000C, HR4000C	Auto desconexión	194997-4
CB-318	9561/C/CV, 9564/C/CV/CVR/PC/PCV, BO6040, GD0800C, GD0810C, PW5001C, SA5040C, SG1250	Auto desconexión	196454-8
CB-325	9554HN/NB, 9557HN/HP/NB/PB, 9564H, GA5040 GD0600,HR2230, HR2300, GA5040, GD0600, HR2230 HR2300,HR2460, HR2470, HR2600, HR2610, HR1810/T		195001-2
CB-327	HR3000C (220V)	220V Auto desconexión	194997-4
CB-350	HM0870C, HM0871C,HR3200C, HR3210C, HR3540C, HR4001C, HR4002, HR4011C	Auto desconexión	197244-2
CB-401	6302/H, 6303/H, 6402, 6820V, 6904VH, 6905H, HP1030, HP1310		195005-4
CB-407	4304, 4305, 4340FCT, 4350FCT, 4350T, 6407, 6408, 6807 6821, 6824N, 6825, 6826, 6827, 8450, 9046, BO4556 BO4557, BO4558, BO4900/V, BO5030, BO6030, DA3010F, DP3002, DP3003, DP4000, DP4001, DP4002, DP4003,DP4011, FS2500, FS2700, FS2701, FS4200, FS6300,HP1230, HP1500, HP1510, HP1620, HP1640, HP2030,HP2032, HP2034, HP2040, HP2042, HP2050, HP2070,HR2420, HR2431, HR2440, HR2450, SJ1300, SJ8000,MBO450, MBO451, MBO500, MT920, TD0100, UH4261,UH4261, UH5570		195007-0
CB-408	3707FC, 3709, 3901, 6832, 6834, 6846, 6922NB, 6951 6953, 9031,9032, 9500N, 9501B, 9505BH, 9523NBH 9524, 9524NB, 9527, 9527PB, 9551, 9911, DS4010 DS4011, DS5000, JN1601, KP0800, MGA400 MGA450, MGA452, MGD100, MGD101, MKP080 MKP082, MT370, MT910, MT951, MT952, MTR100 RT0700C, TD0101F, TW0200, TW0350		195008-8
CB-415		220 V	195012-7
CB-416	HR2400		195013-5
CB-424	6503D, 6914D		195017-7
CB-430	6213D, 6233D, 6313D, 6317D, 6319D, 6333D, 6337D 6339D, 6343D, 6347D, 6349D, 8413D, 8414D, 8433D 8434D, 8443D, 8444D, BDF460, BGA452, BHR200, BHR240 BJS161, BPB180, BUC122, LXDG01, LXJP02, UB360D		195018-5
CB-434	6916FD, 6918D, 6932FD, 6935FD, 6936FD, 6980FD, BFL080F, BFL081F, BFL120F, BFL121F, BFL200F, BFT020F, BFT040F		195020-8
CB-440	BDF440, BDF441, BDF451, BDF452, BDF440, BHP441 BHP450, BHP451, BHP452, BTD130F, BTD140, BTD141 BTD142, BTP140, BTW251, BTW253, LXDT04, LXF001 LXP01, LXP02, LXS01		195021-6
CB-441	BHR202, BJR181, BSS610, BSS611 BTD200, BTW450, LXPK01, LXL01		195022-4
CB-442	BHR261, BUC250, BUH550, UC250D, UHS50D, UH650D		195023-2
CB-452	6952		195024-0
CB-458	GA4530, GA4534, MHR200, PJ7000		195025-8

Juegos de servicio



Modelo	Tipo	No. Parte
HM0860C	-	195204-8
HM0870C, HM0871C	-	195113-1
HM1100 / C	-	193243-2
HM1200 / B	-	193244-0
HM1202 / C	-	193391-7
HM1203C, HM1205C, HM1213C, HM1214C	-	195114-9
HM1303 / B	-	193393-3
HM1304 / B	-	195201-4
HM1307C, HM1307CB, HM1317C, HM1317CB	-	195103-4
HM1800	-	193402-8
HM1801, HM1810	-	195205-6
HR1830 / F	-	195198-7
HR2010	B	193396-7
HR2020, HR2021, HR2022, HR2440, HR2441 HR2442, HR2445, HR2450/F/FT/T, HR2451	-	193606-2
HR2800, HR2810/T, HR2811F/FT	-	195206-4
HR2230, HR2460/F, HR2470/F/FT/ T	-	195263-2
HR3000C	-	193390-9
HR3200C, HR3210C, HR3210FCT	-	195199-5
HR3540C, HR3541FC	-	195192-9
HR3850/B, HR3851	-	193281-4
HR4000C	-	193283-0
HR4001C, HR4002, HR4010C, HR4011C	-	195195-3
HR5001C	-	193392-5
HR5201C, HR5210C, HR5211C	-	195191-1
HM0830	-	185200-6
HR5202C, HR5212C	-	196865-7
MHM080	-	196918-2
HM1802, HM1812	-	197127-6

Grasa para martillos rotativos



Usar en	Descripción	Contenido	No. Parte
Todos los modelos	Grasa para martillos (para lubricación de la cámara de compresión)	30g	181490-7
HM1812	Grasa para martillos (para lubricación de la cámara de compresión)	500g	042040-2A
Todos los modelos	Grasa para martillos (para lubricación de la cámara de compresión)	500g	194683-7



HM1812
Rompedor eléctrico



CENTROS DE SERVICIO DE FÁBRICA

MAKITA MÉXICO CIUDAD DE MÉXICO (D.F.)

NORTE 35 # 780 C
COL. IND. VALLEJO C.P. 02300
MÉXICO, D.F.
TEL: 55 53 68 11 05
FAX: 55 55 67 33 87 TALLER EXT 110
CONMUTADOR EXT 101
E-MAIL: serviciodf@makita.com.mx

MAKITA GUADALAJARA

AV. SIERRA MAZAMITLA # 5864
COL. PINAR DE LA CALMA REFORMA C.P. 45080
ZAPOCAN, JALISCO
TEL: 333 632 80 32 / 36 32 80 57
E-MAIL: serviciogdl@makita.com.mx

MAKITA MONTERREY

AV. PABLO LIVAS # 4207
COL. GUADALUPE VICTORIA C.P. 67180
GUADALUPE, NUEVO LEÓN
TEL: 818 372 42 05 / 372 41 93
E-MAIL: serviciomty@makita.com.mx

CENTROS DE SERVICIO AUTORIZADOS MAKITA

AGUASCALIENTES

PRESISA HERRAMIENTAS

IGNACIO ZARAGOZA # 1105
COL. FRACC. EL SOL C.P. 20030
AGUASCALIENTES, AGUASCALIENTES
TEL: 449 146 41 81 / 146 41 80
E-MAIL: presisa.herramientas@gmail.com

TOOLS & EQUIPMENT RED SUPPLIES

AV CONVENCION OTE # 526 COL. SANTA ANITA
C.P. 20169 AGUASCALIENTES, AGUASCALIENTES
TEL: 449 658 72 73
E-MAIL: simonfuentes@redsupplies.mx

GRUPO MULTIHERRAMIENTAS

HÉROE DE NACAZARI NORTE # 1116-A
COL. GREMIAL C.P. 20030
AGUASCALIENTES, AGUASCALIENTES
TEL: 449 916 11 27 / 916 45 49
E-MAIL: multiherramientas@prodigy.net.mx

BAJA CALIFORNIA NORTE

TIJUANA

COMERCIAL DE ACEROS Y PERFILES FRONTERA

BLVD. CUCAPAH # 20498
COL. BUENOS AIRES SUR C.P. 22207
TIJUANA, B.C.N.
TEL: 664 661 05 67 / 629 58 28 Ext. Taller 106
E-MAIL: daniela.moroyoti@acerosfrontera.com

OXIGENO Y EQUIPOS, S.A.

BLVD. AGUA CALIENTE # 1630
COL. FRACC. NEIDHART C.P. 22420
TIJUANA, B.C.N.
TEL: 664 686 12 11 / 686 13 61
E-MAIL: recepcion@oasatijuana.com

CLUB FERRETERO SA DE CV

AV. MILTON CASTELLANOS # 19
COL. AGUAJE DE LA TUNA 2 da. SECCION
C.P. 22490 TIJUANA, B.C.N.
TEL: 664 626 65 21
E-MAIL: club_ferretero@hotmail.com

CONSTRUCTION WORLD DE MEXICO S.A. DE C.V

BLVD. MANUEL J. CLOUTHIER # 3980
COL. MURUA OTE. C.P. 22465
TIJUANA, B.C.N.
TEL: 664 973 51 70
E-MAIL: compras@cwmexico.com

PINVELMEX/HERMAQ DEL NORTE

C. HORTENCIA HERNANDEZ M6 L1,
COL. MANCLOVIO ROJAS,
C.P. 22254 TIJUANA, B.C.N.
TEL: 664 848 39 90
E-MAIL: makitastoretx@hotmail.com

MEXICALI

NDT DEL PACIFICO

BLVD LAZARO CARDENAS 1651 LOCAL14
COL. DESARROLLO URBANO ZACATECAS
C.P. 21389, MEXICALI, B.C.N.
TEL: 686 561 87 99
E-MAIL: conadyser@yahoo.com.mx
conadyser1@gmail.com

CORPORATIVO VYK S.C. DE R.L. DE C.V.

BLVD. LAZARO CARDENAS # 1017
COL. INDEPENDENCIA C.P. 21290
MEXICALI, B.C.N.
TEL: 686 564 93 30 al 33
E-MAIL: ccordova@vykherramientas.com
vykherramientas@hotmail.com

OASA MEXICALI

BLVD. ADOLFO LOPEZ MATEOS # 850
COL. BELLAVISTA C.P. 21150 MEXICALI, B.C.N.
TEL: 686 551 62 00 / 551 62 12
E-MAIL: clientes@oasa.com.mx

COMERCIALIZADORA BORHANS

RIO SAN LORENZO #216 COL. COMPUERTAS
C.P. 21218 MEXICALI, B.C.N.
TEL: 686 565 26 35
E-MAIL: demostrador@jborhans.com

TORMEX

AV. ACATITA DE BAJAN NO.1045
COL. INDEPENDENCIA C.P. 21290 MEXICALI, B.C.N.
TEL: 686 565 37 90
E-MAIL: tormex_01@hotmail.com

ENSENADA

EQUIPOS Y SOLDADURAS DEL NORTE

AV. JUÁREZ # 1519 ESQ. GUADALUPE
COL. OBRERA C.P. 22830 ENSENADA, B.C.N.
TEL: 646 177 00 10 / 176 47 20
FAX: 646 177 18 18
E-MAIL: davidsotoens@hotmail.com

TECATE

DISTRIBUIDORA DE MATERIALES PARA LA CONSTRUCCION GUADALAJARA

RIO EUFRATES LOTE 5 Y 6 S/N
FRAC. JARDINES DEL RIO C.P. 21478
TECATE, B.C.N.
TEL: 665 521 11 62
E-MAIL: construrama.guadalajara@gmail.com

BAJA CALIFORNIA SUR

CD CONSTITUCIÓN

ELECTRICA Y PLOMERIA DE SUDCALIFORNIA

PINO SUÁREZ #19 COL. CENTRO
C.P. 23600, CD. CONSTITUCIÓN, B.C.S.
TEL: 613 132 36 33 / 132 3733
E-MAIL: eyplosud@prodigy.net.mx

CABO SAN LUCAS

CONSTRU CENTRO

AV. REFORMA LOTE 21 MZ 218
COL. EL ARENAL, C.P. 23460 CABO SAN LUCAS, B.C.S.
TEL: 624 143 49 84 / 143 4989
E-MAIL: contabilidad@constru-centro.com.mx

LA PAZ

EQUIPOS Y REMOLQUES DE LA PAZ

BLVD. EUSEBIO KINO # 1825
ENTRE BRAVO Y OCAMPO COL. GUERRERO
C.P. 23020 LA PAZ, B.C.S.
TEL: 612 185 28 40
E-MAIL: equiposyremolquesdelapaz@gmail.com

VAZOL SERVICIOS

BLVD. AGUSTIN OLACHE AVILES #3023
COL. ARBOLERAS C.P. 23090
LA PAZ, B.C.S.
TEL: 612 129 69 49
E-MAIL: vazolservicios@yahoo.com.mx

SAN JOSÉ DEL CABO

CONSTRU-RENTAS

CARR. FEDERAL LIBRE TRANSPENINSULAR
SAN JOSÉ-SAN LUCAS MARGEN IZQ. #3015 S/N
COL. LOMAS DE GUAYMITAS, C.P.23445
SAN JOSÉ DEL CABO, B.C.S.
TEL: 624 123 46 55
E-MAIL: construrentas_baja@hotmail.com

FIERRO Y LAMINA CONSTRUCCIÓN

CARRETERA TRANSPENINSULAR KM 33.5 INT.1
COL. GUAYMITAS, C.P. 23407
SAN JOSÉ DEL CABO, B.C.S.
TEL: 624 247 48 00
E-MAIL: sanjose3ventas@fierroylamina.com.mx

MG2 (SAN JOSÉ DEL CABO)

CARR. FEDERAL LIBRE TRANSPENINSULAR SAN JOSÉ,
SAN LUCAS KM 38.5 COL. ZACATAL
SAN JOSÉ DEL CABO, B.C.S. C.P. 23427
TEL: 624 12 013 26
E-MAIL: patriciacovarrubias@live.com.mx
patricia@caborentas.mx

DE TODOS LOS SANTOS

MG2, (TODOS LOS SANTOS)

CALLE RANGEL ENTRE MORELOS Y MARQUEZ DE LEON
COL. CENTRO, C.P.23300
TODOS LOS SANTOS, B.C.S.
TEL: 612 145 10 43
E-MAIL: patriciacovarrubias@live.com.mx
patricia@caborentas.mx

CAMPECHE

C.D. DEL CARMEN

FERREVITOLIN

AV. JUÁREZ # 218 ESQ. CON 35-A
COL. FATIMA C.P. 24110
C.D. DEL CARMEN, CAMPECHE
TEL: 938 382 57 70
E-MAIL: vitolin22@hotmail.com

CAMPECHE

COMERCIALIZADORA DE MATERIALES Y SERVICIOS INTEGRALES HERON

AZTECA # 5 ENTRE ECUADOR Y SAN DIEGO
COL. TOMAS ASNAR, C.P. 24080
CAMPECHE, CAMPECHE
TEL: 981 146 23 03
E-MAIL: makitaazteca@outlook.com

TEKNOH

AV. CIRCUITO CONSTITUCION # 25
COL. PEÑA, C.P. 24089
CAMPECHE, CAMPECHE
TEL: 981 144 08 73
E-MAIL: teknohrent@hotmail.com



ESCARCEGA

DISTRIBUIDORA EMJO

CALLE 31 S/N POR 34 Y 36
COL. SALSIPUEDES C.P. 24350
ESCARCEGA, CAMPECHE
TEL: 982 824-03-80 / 824-04-18
CEL: 982 118 35 34
E-MAIL: ventas@emjo.mx

CHIAPAS

TUXTLA GUTIÉRREZ

HERRAJES FINOS COPICO

AV. 9a SUR ORIENTE Y 5a ORIENTE # 590-A
COL. OBRERA C.P. 29000
TUXTLA GUTIÉRREZ, CHIAPAS
TEL: 961 613 85 86 / 614 73 29
E-MAIL: centrodeservicio@hfcopico.com

FERRETERA MANDIOLA

5a. NORTE ORIENTE # 245
COL. BARRIO SAN JACINTO C.P. 29000
TUXTLA GUTIÉRREZ, CHIAPAS
TEL: 961 613 89 20 / 613 89 21
E-MAIL: oriente@mandiola.com.mx

CENTRO DE SERVICIO DEL SURESTE

1RA ORIENTE NORTE # 705
COL. BARRIO SAN JACINTO, C.P. 29000
TUXTLA GUTIÉRREZ, CHIAPAS
TEL: 961 223 22 71 / 213 78 97
E-MAIL: serviciodelsureste@live.com.mx

SAN CRISTÓBAL DE LAS CASAS

FERRETERA CASUA

CALLE COSTA RICA # 16
COL. CENTRO ZONA MERCADO C.P. 29240
SAN CRISTÓBAL DE LAS CASAS, CHIAPAS
TEL: 967 678 62 83 / 678 25 41
E-MAIL: cp_jcam@hotmail.com

FERREVIDRIO

EJE VIAL 1 #34
COL. SECTOR SALUD C.P. 29286
SAN CRISTÓBAL DE LAS CASAS, CHIAPAS
TEL: 967 678 87 47
E-MAIL: ferrevidriojevial1@hotmail.com

COMITÁN DE DOMÍNGUEZ

CENTRO DE SERVICIO PINEDA

4-A. AVENIDA PONIENTE SUR LOCAL 4
ENTRE 14 SUR PONIENTE
COL. BELISARIO DOMÍNGUEZ C.P. 30040
COMITÁN DE DOMÍNGUEZ, CHIAPAS
TEL: 963 10 13 801
E-MAIL: comitan@serviciopineda.com.mx

TAPACHULA

GRUPO ICI-EXYPRO CARDENAS HERMANOS MS LOS PINOS

1BOULEVARD FERROCARRIL # 10
COL VILLA LAS FLORES C.P. 30795
TAPACHULA, CHIAPAS
TEL: 962 626 21 27
E-MAIL: serviciotecnico.ghc@gmail.com

TORNILLOS Y HERRAMIENTAS DEL SURESTE

17 PONIENTE # 20-A ENTRE 4A Y 6A NORTE
COL CENTRO C.P. 30700
TAPACHULA, CHIAPAS
TEL: 962 626 28 07
E-MAIL: mario16416@gmail.com

CHIHUAHUA

CHIHUAHUA

MULTIHERRAMIENTAS Y SERVICIOS DEL NORTE

AV. TECNOLÓGICO # 11302-A
COL. REVOLUCIÓN C.P. 31135
CHIHUAHUA, CHIHUAHUA
TEL: 614 440 10 22 / 296 57 64
E-MAIL: daniel.makita@hotmail.com

SOLUCIONES INDUSTRIALES JR

H. COLEGIO MILITAR # 4307-A
COL. NOMBRE DE DIOS C.P. 31110
CHIHUAHUA, CHIHUAHUA
TEL: 614 341 03 14 / 341 03 15
E-MAIL: solucionesindustriales.ch@gmail.com

GASES Y ELECTRODOS DE CHIHUAHUA

TITANIC # 330
COL. MIRAMAR C.P. 31104
CHIHUAHUA, CHIHUAHUA
TEL: 614 293 86 79
E-MAIL: gasesyelectrodos@hotmail.com

RL TOOLS

AV. 20 DE NOVIEMBRE # 2300 INT.C
BARRIO DE LONDRES C.P. 31060
CHIHUAHUA, CHIHUAHUA
TEL: 614 413 64 04
E-MAIL: rltools100@gmail.com

C.D. CUAUHEMOC

MOTOPARTES EL CORREDOR

CAMPO 12 KM 32 CARRETERA
CUAUHEMOC ALVARO OBREGÓN
COL. MANITOBA C.P. 31500
CD. CUAUHEMOC, CHIHUAHUA
TEL: 625 578 62 22 (23 y 21)
E-MAIL: motopartes_13@hotmail.com

CAMARGO

TORQUE MAQUINAS

AV. DIVISIÓN DEL NORTE # 707
COL. REVOLUCIÓN C.P. 33740
CAMARGO, CHIHUAHUA
TEL: 648 462 41 56
E-MAIL: elalomak@hotmail.com

HIDALGO DEL PARRAL

FERRETERIA REGIONAL DEL PARRAL

AV. NIÑOS HEROES KM 2.4
COL. ALMACEÑA C.P. 33825
CD. HIDALGO DEL PARRAL, CHIHUAHUA.
TEL: 627 527 09 50 / 527 09 51 / 527 09 52
E-MAIL: ferrepasa2@prodigy.net.mx
CD. DELICIAS

DELICIAS

PROINSA GAS

AV. 4A SUR # 2604
COL. TIERRA Y LIBERTAD C.P. 33088
CD. DELICIAS, CHIHUAHUA
TEL: 639 470 19 14
E-MAIL: proinsa_gas@yahoo.com.mx

SERVICIO AGRICOLA INTEGRAL DELICIAS

CALZADA DEL CHORRO # 801
COL. SECTOR NORTE C.P. 33000
CD. DELICIAS, CHIHUAHUA
TEL: 639 474 09 46
E-MAIL: saidedelicias@hotmail.com

CD. JUÁREZ

GARLE

RAMÓN RAYÓN #802,
COL. NUEVA ZARAGOZA C.P. 32000
CD. JUAREZ, CHIHUAHUA
TEL: 656 640 43 04 / 624 75 25
E-MAIL: humbertogutierrez@garle.com.mx

OXIGENO Y SOLDADURAS DE JUÁREZ

BLVD. OSCAR FLORES # 2695
COL. FRACC. DIVISIÓN DEL NORTE C.P. 32688
CD. JUÁREZ, CHIHUAHUA
TEL: 656 610 61 89 / 610 61 04
E-MAIL: oasajz@prodigy.net.mx

CD. JIMENEZ

ANDAMIOS Y REVOLVEDORAS

CALLE CENTENARIO # 230
COL. ANDAVAZO C.P. 33980
CD. JIMENEZ, CHIHUAHUA
TEL: 629 118 27 66
E-MAIL: ing.standar@hotmail.com

COAHUILA

SALTILLO

CENTRO DE HERRAMIENTAS SALINAS

FRANCISCO COSS # 592-A ESQ. ARTEAGA
COL. CENTRO C.P.25000
SALTILLO, COAHUILA
TEL: 844 412 15 55
E-MAIL: makitasaltillo@hotmail.com

MONCLOVA

VGM SUMINISTROS INDUSTRIALES

CUAUHTÉMOC # 1406 ESQ. CON CHARCO AZUL
COL. EL PUEBLO C.P. 25730
MONCLOVA, COAHUILA
TEL: 866 633 00 44
E-MAIL: vgmsumind@prodigy.net
vgmedmundo@hotmail.com

RAMOS ARIZPE

CASA ROJAS DE RAMOS ARIZPE

ACEQUIA DE VENTANAS # 1823
COL. EL CAPITAN, C.P. 25903
RAMOS ARIZPE, COAHUILA
TEL: 884 488 50 50
E-MAIL: rojasluis7204@gmail.com

TORREÓN

MINOTAURO

BLVD. INDEPENDENCIA #76 ORIENTE
COL. CENTRO C.P. 27000 TORREON, COAHUILA
TEL: 871 718 70 80 / 718 72 72
E-MAIL: tallermatriz@minotauroherramientas.com
ventasmatriz@minotauroherramientas.com

CIA MERCANTIL FERRETERA

PRESIDENTE CARRANZA # 3961
COL. SAN MARCOS. CP 27040, TORREÓN, COAHUILA
TEL: 871 713 34 52 Ext. Taller 232 y Gerencia 229
E-MAIL: taller.servicio@mercantilferreteria.com

LAGACERO GROUP TORREÓN

CALZ. CUAUHEMOC # 965 NTE.
COL. CENTRO C.P. 27000 TORREON, COAHUILA
TEL: 871 713 72 12 / 713 35 03
E-MAIL: servicios@lagacerogroup.com

DW CENTER

BLVD. INDEPENDENCIA# 96 PTE.
COL. CENTRO C.P. 27000 TORREON, COAHUILA
TEL: 871 711 28 54 / 716 03 80 / 716 52 65
E-MAIL: dwtorreon@gmail.com

LAGUNA TOOLS DE MEXICO

BAHIA DE LAS PALMAS # 741
COL. NUEVA CALIFORNIA C.P. 27089
TORREON, COAHUILA
TEL: 871 730 14 73
E-MAIL: contabilidad@lagunatools.com.mx





CD. ACUÑA

ACUÑA REFACCIONES Y ELECTROMECAÁNICA
LIBRAMIENTO EMILIO MENDOZA CISNEROS # 295
COL. TIERRA Y LIBERTAD C.P. 26237
CD. ACUÑA, COAHUILA
TEL: 877 772 51 96
E-MAIL: mesaacuna@prodigy.net.mx

COLIMA

LA CUADRA DE LA HERRAMIENTA
FILOMENO MEDINA # 125
COL. CENTRO C.P. 28000 COLIMA, COLIMA
TEL: 312 312 41 13
E-MAIL: makitacolima@hotmail.com

MANZANILLO

EQUIPO Y MAQUINARIA DEL PACIFICO
BLVD. COSTERO MIGUEL DE LA MADRID #14945-A
COL. OLAS ALTAS C.P. 28860
MANZANILLO, COLIMA
TEL: 314 336 95 41 / 145 23 43
E-MAIL: makita.manzanillo@gmail.com

CIUDAD DE MÉXICO

ELECTRO TÉCNICA EN HERRAMIENTAS
AV. LEÓN DE LOS ALDAMA # 315
COL. SAN FELIPE DE JESUS C.P. 07510
DEL. GUSTAVO A. MADERO, CIUDAD DE MÉXICO
TEL: 55 27 33 05 70
E-MAIL: electrotecnicaenherramientas@outlook.com

CASA IKEDA

AV. OBSERVATORIO # 238
COL. DANIEL GARZA C.P. 11830
DEL. MIGUEL HIDALGO CIUDAD DE MÉXICO
TEL: 55 52 71 19 10 FAX: 55 52 72 45 77
E-MAIL: casaikedaventas@hotmail.com

HERRAMIENTAS Y SERVICIOS PROFESIONALES

CORREGIDORA # 38 LOCAL 201-202
COL. CENTRO C.P. 06050
ÁREA 5, CIUDAD DE MÉXICO
TEL: 55 55 42 41 85 / 55 42 40 24
E-MAIL: hyspcentro@hotmail.com

CENTRO DE SERVICIO ARAGÓN

VOLCÁN LANIN # 51
COL. AMPLIACIÓN PROVIDENCIA C.P. 07560
DEL. GUSTAVO A MADERO, CIUDAD DE MÉXICO
TEL: 55 67 98 68 45
E-MAIL: antonycp@hotmail.com

HERRAMIENTAS ELÉCTRICAS ZARAGOZA

CALZ. IGNACIO ZARAGOZA MZ. 108 LT. 904
COL. SANTA MARTHA ACATITLA C.P. 09510
DEL. IZTAPALAPA, CIUDAD DE MÉXICO
TEL: 55 54 41 95 96 / 22 37 18 63
E-MAIL: herramientaszaragoza@hotmail.com

TSP TECNO SERVICIOS PROFESIONALES

AV. LUIS SPOTA # 125-3
COL. INDEPENDENCIA C.P. 03630
DEL IZTAPALAPA, CIUDAD DE MÉXICO
TEL: 55 56 72 58 47
E-MAIL: tecno.pablo2@hotmail.com

PEDRO BALDOVINOS E HIJOS

CHIAPAS # 49
COL. ROMA C.P. 06700
DEL. CUAUHTÉMOC, CIUDAD DE MÉXICO
TEL: 55 5 564 58 78 / 55 84 49 12
E-MAIL: hdez_teo@yahoo.com

RIDSA CDMX

RAFAEL BUELNA #1
COL. TEZOZOMOC C.P. 02459
DEL. AZCAPOTZALCO, CIUDAD DE MÉXICO
TEL: 55 55 83 52 55 / 26 26 16 52
E-MAIL: a.quezada@ridsamexico.com

HERRAMIENTAS ELÉCTRICAS E INDUSTRIALES

EJIDO MANZANA 28 LOTE 21-A
COL. SAN FRANCISCO TLALTENCO C.P. 13400
CIUDAD DE MÉXICO
TEL: 55 25 94 42 56 / 63 65 07 14
E-MAIL: htaselect_einds@hotmail.com

GENERAL EN HERRAMIENTAS Y SERVICIO

AV. OCHO #438
COL. PUEBLA C.P. 15020
VENUSTIANO CARRANZA, CDMX
TEL: 55 57 00 57 90 / 55 57 00 34 95
E-MAIL: ventasghs@outlook.com

DURANGO

HERRAMIENTAS Y ABRASIVOS DURANGO

AV. 20 DE NOVIEMBRE # 2004 OTE.
COL. CENTRO C.P. 34000
DURANGO, DURANGO
TEL: 618 818 80 77 / 455 36 56
E-MAIL: hyadurango@hotmail.com

REFACCIONARIA FORESTAL GUADIANA

PROL. BLVD. DOLORES DEL RIO # 210
COL. AZCAPOTZALCO C.P. 34160
DURANGO, DURANGO
TEL: 618 813 47 50
E-MAIL: refaccionariaforestalguadiana@hotmail.com

REFACCIONARIA FORESTAL GUADIANA

AV. JESÚS GARCÍA #507
COL. LOPEZ MATEOS C.P. 34210
DURANGO, DURANGO
TEL: 618 455 2268
E-MAIL: refaccionariaforestalguadiana@hotmail.com

ESTADO DE MÉXICO

TOLUCA

RIDSA TOLUCA

BLVD. SOLIDARIDAD LAS TORRES # 1304B
COL. EL SEMINARIO 1 SECCIÓN C.P. 50170
TOLUCA, EDO. DE MÉXICO
TEL: 722 394 29 36
E-MAIL: herramientasmakita@outlook.com

SERVICIOS ESPECIALIZADOS DE TOLUCA

VIALIDAD ALFREDO DEL MAZO # 70-C
COL. ZONA INDUSTRIAL C.P. 50070
TOLUCA, EDO. DE MÉXICO
TEL: 722 167 11 97
E-MAIL: ernesto_bermudez59@hotmail.com

FERRETERIA GRUPO HERMANOS FLORES TOLUCA

CALLE FELIPE BERRIOZABAL # 509-B
COL. VALLE VERDE C.P. 50140
TOLUCA, EDO. DE MÉXICO
TEL: 722 212 44 31
E-MAIL: ventas.mp@grupohfiores.com

OCOYOACAC

SERVICIO TECNICO MARTINEZ

AV. 16 DE SEPTIEMBRE # 92
COL. BARRIO STA. MARÍA OCOYOACAC
C.P. 52740 OCOYOACAC EDO. MÉXICO
TEL: 729 360 06 55 / 722 855 63 85
EMAIL: max.mtz@live.com

IXTALAN DE LA SAL

FERRETERIA Y TLPALERIA CASA PEDROZA

ALLENDE S/N ESQUINA CON ZARAGOZA
COL. SANTA CATAILINA, C.P. 51900
IXTALAN DE LA SAL, EDO. DE MÉXICO
TEL: 722 523 88 50
E-MAIL: ferre_pedroza@hotmail.com

VALLE DE BRAVO

FERRETERÍA GRUPO HERMANOS FLORES

VALLE DE BRAVO
AV BENITO JUÁREZ# 501
COL. SAN ANTONIO C.P. 51200
VALLE DE BRAVO, EDO. DE MÉXICO
TEL: 726 262 22 27
E-MAIL: ventas.mp@grupohfiores.com

FERRETERÍA GRUPO HERMANOS FLORES AVANDARO

AV. ROSALES S/N ESQUINA CON VEGA DEL LLANO
COL. AVANDARO C.P. 51200
VALLE DE BRAVO, EDO. DE MÉXICO
TEL: 726 266 17 43
E-MAIL: ferrymatav@grupohfiores.com

ATLACOMULCO

HERRAMIENTAS Y REPARACIONES HEANI

AV. HIDALGO ESQ. ALFREDO DEL MAZO #37
COL. ATLACOMULCO C.P. 50450
ATLACOMULCO, EDO. DE MÉXICO
TEL: 722 631 04 07 / 712 132 11 05
E-MAIL: herramientas.atlacomulco@hotmail.com

NAUCALPAN

PROMOTORA Y DISTRIBUIDORA DE HERRAMIENTA SAVI

AV. 16 DE SEPTIEMBRE # 515 LOCAL A
COL. FRACC. INDUSTRIAL ALCE BLANCO
C.P. 53370 NAUCALPAN, EDO. DE MÉXICO
TEL: 55 88 48 74 88 / 55 88 48 74 72
E-MAIL: jorge@herramientassavi.com

TLALNEPANTLA

HERRAMIENTAS AMBAR

AV. TOLTECAS # 275
COL. LA ROMANA C.P. 54030
TLALNEPANTLA, EDO. DE MÉXICO
TEL: 55 53 90 74 80
FAX: 55 65 23 12
E-MAIL: herambar@prodigy.net.mx

HERRAMIENTAS Y REPARACIONES LA LOMA

VIA GUSTAVO BAZ PADRA # 242 ESQ. CHALMA
COL. TLALNEMEX C.P. 54070
TLALNEPANTLA, EDO. DE MÉXICO
TEL: 55 53 65 52 20
E-MAIL: herramientaslaloma@yahoo.com.mx

PEDRO BALDOVINOS E HIJOS

AV. DE LOS MAESTROS # 53 ESQUINA ROJO
GOMEZ, COL. SAN ANDRES ATENCO, C.P. 54040
TLALNEPANTLA, EDO. DE MÉXICO
TEL: 55 24 51 80 39
E-MAIL: suc_tlalnepantla@baldovinos.com.mx

ECATEPEC DE MORELOS

TW HERRAMIENTAS ELECTRICAS ECATEPEC

AV. MORELOS OTE # 43-A
COL. SAN CRISTOBAL C.P. 55000
ECATEPEC, EDO. DE MÉXICO
TEL: 55 57 7053 42 / 36 12 04 07
E-MAIL: daniel_grupoterwogt@hotmail.com
NEZAHUALCOYOTL

CIUDAD NEZAHUALCOYOTL

MARBAL HERRAMIENTAS Y SERVICIO

CABALLO BAYO # 161-A
COL. BENITO JUAREZ C.P. 57000
CIUDAD NEZAHUALCOYOTL, EDO. DE MÉXICO
TEL: 55 57 36 84 02 / 51 12 13 64
E-MAIL: marbal-@hotmail.com

**SAN JUAN TEOTIHUACAN****HERRAMIENTAS ELECTRICAS Y COMBUSTIÓN**

ABASOLO #3 COL. CENTRO C.P. 55800
SAN JUAN TEOTIHUACAN, EDO. DE MÉXICO
TEL: 594 958 90 88
E-MAIL: herramientasfrm@gmail.com

TECAMAC**SERVICIOS Y HERRAMIENTAS DE TECAMAC**

MÉXICO PACHUCA KM. 38 S/N
COL. CENTRO C.P. 55740
TECAMAC, EDO. DE MÉXICO
TEL: 55 59 34 42 80 / 65 81 29 94
E-MAIL: jjenzastiga@hotmail.com
jjenzastiga@gmail.com

TEXCOCO**HERRAMIENTAS TEXCOCO**

NICOLAS BRAVO S/N
COL. LAS SALINAS C.P. 56152
TEXCOCO, EDO. DE MÉXICO
TEL: 595 931 34 20
E-MAIL: herrinec@hotmail.com

ZUMPANGO**CONSTRUCTORA Y ARRENDADORA GRUPO RAMOS HNOS SA DE CV**

AV. 16 DE SEPTIEMBRE # 78 COL. BARRIO SAN MIGUEL /
SAN JUAN ZITLALTEPEC C.P. 55628
ZUMPANGO, EDO. DE MÉXICO
TEL: 591 611 05 73
E-MAIL: compras@gruporamoshnos.com

GUANAJUATO**LEON****GB SERVICIOS Y HERRAMIENTAS**

BLVD. ADOLFO LOPEZ MATEOS # 1127 OTE.
COL. COECILLO C.P. 37260
LEON, GUANAJUATO
TEL: 477 713 07 72 / 716 50 91 / 514 38 70
E-MAIL: sherdeleongb@hotmail.com

HERRAMIENTAS Y SERVICIOS DE LEÓN

BLVD. ADOLFO LOPEZ M. # 230 OTE.
COL. CENTRO C.P. 37000
LEÓN, GUANAJUATO
TEL: 477 714 65 14
E-MAIL: h_s_leon@hotmail.com

MOROLEON**AGROFERRETERA SERVICIOS**

LAZARO CARDENAS # 50-B
COL. CENTRO C.P. 38961
MOROLEON, GUANAJUATO
TEL: 445 458 28 23
E-MAIL: compras@agroferreteria.com

IRAPUATO**LARD. EQUIPOS MECÁNICOS**

AV. 1 DE MAYO # 482
COL. CENTRO C.P. 36500
IRAPUATO, GUANAJUATO
TEL: 462 626 79 22 / 660 24 57
E-MAIL: lard_equipos@hotmail.com

HEDELBA HERRAMIENTAS Y SERVICIOS INDUSTRIALES

INDEPENDENCIA 1327 COL. LOS PRESIDENTES
IRAPUATO, GUANAJUATO CP.36550
TEL 462 626 2348 / CEL: 46 2220 8419
E-MAIL: ventas1@hedelba.com.mx

CELAYA**HERRAMIENTAS MANOS CREADORAS**

AV. 2 DE ABRIL # 230 LOCAL 204
COL. BARRIO DEL ZAPOTE C.P. 38080
CELAYA, GUANAJUATO
TEL: 461 175 48 48
E-MAIL: htasmanoscreadoras@hotmail.com
ROMITA

HERRAMIENTAS Y MANTENIMIENTO OBREGÓN

ALVARO OBREGÓN # 44
COL. CENTRO C.P. 36200
ROMITA, GUANAJUATO
TEL: 432 745 32 84
E-MAIL: mantoyh.obregon@yahoo.com

SAN MIGUEL DE ALLENDE**COMERCIALIZADORA INDUSTRIAL LANDETA**

CARRETERA SAN MIGUEL DE ALLENDE
A QRO. KM. 2.5
COL. SAN JUAN LANDETA C.P. 37880
SAN MIGUEL DE ALLENDE, GUANAJUATO
TEL: 415 109 03 67
E-MAIL: coinlandeta@gmail.com

GRUPO FERRETERO DON PEDRO

CARRETERA SAN MIGUEL A CELAYA KM 2.4
COL. POBLADO DE DON DIEGO, C.P. 37887
SAN MIGUEL DE ALLENDE, GUANAJUATO
TEL: 415 120 43 53
E-MAIL: servicio@grupodonpedro.com

GUERRERO**ACAPULCO****TOOLS**

BLVD. DE LAS NACIONES # 401 LOCAL 6
COL. GRANJAS DEL MARQUEZ C.P. 39890
ACAPULCO, GUERRERO
TEL: 744 254 54 91 / 254 00 25 / 466 09 12
E-MAIL: ventas@toolsaferreteria.com

ZIHUATANEJO DE AZUETA**FERRETERIA SAN JERÓNIMO**

AV. PASEO DE ZIHUATANEJO OTE # 2
COL. ZONA INDUSTRIAL C.P. 40880
ZIHUATANEJO DE AZUETA, GUERRERO
TEL: 755 554 07 38 / 554 07 39
E-MAIL: jpablo.avila@hotmail.com

OMETEPEC**FERRE ELECTRICA DEL CARMEN**

5 DE MAYO # 7-B
COL. BARRIO DEL CARMEN C.P. 41700
OMETEPEC, GUERRERO
TEL: 741 412 01 65
E-MAIL: ferre_elec_elcarmen@hotmail.com

HIDALGO**PACHUCA****SERVIREP HERRAMIENTAS**

BLVD. MINERO # 700
COL. VENUSTIANO CARRANZA C.P. 42030
PACHUCA HIDALGO
TEL: 771 719 24 94 / 246 42 84
E-MAIL: servicenterpachuca@outlook.com

TULANCINGO**HERRAMIENTAS ELÉCTRICAS BADHER**

LIBERTAD ORIENTE # 301-7
CASI ESQ. MANUEL M. SOTO
COL. CENTRO C.P. 43600
TULANCINGO, HIDALGO
TEL: 775 755 18 85
E-MAIL: badher86@hotmail.com

TULA DE ALLENDE**DISTRIBUIDOR DE HERRAMIENTAS INDUSTRIALES M&M**

CARRETERA ESTATAL TULA ACTOPAN # 7
COL. EL CIELITO C.P. 42800
TULA DE ALLENDE, HIDALGO
TEL: 773 118 02 07
E-MAIL: distribuidoradehimym@gmail.com

JALISCO**GUADALAJARA****MULTI HERRAMIENTAS SA DE CV**

AV. LA PAZ # 343,
COL. MODERNA, C.P. 44190
GUADALAJARA, JALISCO
TEL: 333 826 69 76 / 826 57 74 / 826 91 72
E-MAIL: contacto@multiherramientas.mx

GRUPO CONTINENTE INTERNACIONAL

CALZ. INDEPENDENCIA SUR # 343
COL. ANALCO C.P. 44100
GUADALAJARA, JALISCO
TEL: 333 883 10 30 EXT. 430
E-MAIL: makita_gdl@gcinter.com / ventas@gcinter.com

RIDS SA GUADALAJARA

CALZADA LÁZARO CARDENAS # 1723
COL. DEL SUR C.P. 44920
GUADALAJARA, JALISCO
TEL: 333 813 81 30 / 587 25 50 / 150 63 00
E-MAIL: servicio1@ridsamexico.com

SERVICENTER MAYOREO

AV. RIO NILO # 3094
COL. JARDINES DE LA PAZ C.P. 44860
GUADALAJARA, JALISCO
TEL: 333 659 18 50
E-MAIL: officenter@yahoo.com.mx

TEPATITLAN**MOTOSIERRAS SAN ALFONSO**

BLVD. ANACLETO # GONZALEZ # 1301
COL. JARDINES DEL REAL C.P. 47630
TEPATITLAN, JALISCO
TEL: 378 705 03 15
E-MAIL: info@fsalfonso.com.mx

IMUSA SERVICIO TÉCNICO (TEPATITLÁN)

ANACLETO GONZALEZ FLORES #230
COL. LA ESPAÑA, CP. 47635
TEPATITLÁN, JALISCO
TEL: 378 688 2677 CEL: 33 1865 9487
E-MAIL: raulara@herrajestabares.com

ZAPOPAN**REIKER SUC. PATRIA**

AV. PATRIA # 40-E CASI ESQ. CON AV. VALLARTA
COL. JARDINES VALLARTA C.P. 45027
ZAPOPÁN, JALISCO
TEL: 333 629 37 40
E-MAIL: ventas-pat@reiker.mx

REIKER SUC. GUADALUPE

PROL. AV. GUADALUPE #5763 LT. 7
COL. GRANJAS DEL COLLI C.P. 45010
ZAPOPÁN, JALISCO
TEL: 33 20 16 78 84
E-MAIL: ventas-gpe@reiker.mx

REIKER SUC. AVIACIÓN

LIBRAMIENTO BASE AEREA #489-A
COL. EL TRIAUNGULO C.P. 45138
ZAPOPÁN, JALISCO
TEL: 331 561 47 49
E-MAIL: ventas-aviacion@reiker.mx

HERRAMIENTAS QUINN

OCCIDENTAL #442-B
COL. EL BATÁN C.P. 45190
ZAPOPÁN, JALISCO
TEL: 331 810 68 76
E-MAIL: electro-ferreteria@hotmail.com



ATOTONILCO EL ALTO

IMUSA SERVICIO TÉCNICO
VALENTÍN GÓMEZ FARIAS #227
COL. SAN FELIPE C.P. 47750
ATOTONILCO EL ALTO, JALISCO
TEL: 391 917 28 05
E-MAIL: ventas.imusa@outlook.com

OCOTLÁN

HERRAMIENTAS Y SERVICIOS MIRANDA
AV. 20 DE NOVIEMBRE # 156
COL. MARCOS CASTELLANOS C.P. 47870
OCOTLÁN, JALISCO
TEL: 392 923 23 00 / 719 01 26
E-MAIL: hysosa@hotmail.com

TEQUILA

GRUPO FERRETERO FHEGARSA
CARRETERA INTERNACIONAL # 703-A
COL. EL MALUAZTE C.P. 46400
TEQUILA, JALISCO
TEL: 374 742 73 34 / 742 73 51
E-MAIL: cecis@fhegarsa.com.mx
anguelo@hotmail.com

PUERTO VALLARTA

DISTRIBUIDORA DE HERRAMIENTAS DE LA BAHIA SUC. CENTRO
SAN SALVADOR # 525
COL. 5 DE DICIEMBRE C.P. 48350
PUERTO VALLARTA, JALISCO
TEL: 322 223 08 92
f.centro@distribuidoradeherramientasdelabahia.com

DISTRIBUIDORA DE HERRAMIENTAS DE LA BAHIA SUC. AEROPUERTO
CARRETERA A TEPEC # 4760-A
COL. GUADALUPE VICTORIA, C.P. 48317
PUERTO VALLARTA, JALISCO
TEL/FAX: 322 221 21 00
f.aeropuerto@distribuidoradeherramientasdelabahia.com

MICHOACÁN

MORELIA

ACEROS Y HERRAJES S.A. DE C.V.
AV. MORELOS NORTE # 1861
COL. SANTIAGUITO C. P. 58120
MORELIA, MICHOACÁN
TEL: 443 313 13 13 con 10 Líneas
E-MAIL: ventas@ahsa.com.mx

CD. HIDALGO

MARTÍNEZ HERRAMIENTAS
FELIPE ANGELES # 31
COL. LAZARO CARDENAS C. P. 61150
CD HIDALGO, MICHOACÁN
TEL: 786 154 42 13
E-MAIL: martinezherramientas@hotmail.com

HUETAMO DE NUÑEZ

FERRETECK FERRETERIAS
CALLE EXTENSION SUR S/N COL. DOLORES
C.P. 61940 HUETAMO DE NUÑEZ, MICHOACAN
TEL: 435 688 19 69
E-MAIL: ventas@ferreteck.com

URUAPÁN

HERRAMIENTAS COVARRUBIAS
PASEO LAZARO CARDENAS # 1049
COL. LA MAGDALENA C.P. 60080
URUAPÁN, MICHOACÁN
TEL: 452 524 70 24 / 524 65 01
FAX: 452 148 02 62
E-MAIL: makitaurapanbryan@gmail.com

HERRAMIENTAS Y SERVICIOS R.L. (MORELOS)

FRANCISCO VILLA # 6-A
COL. MORELOS C.P. 60050
URUAPÁN, MICHOACÁN
TEL: 452 690 56 27
E-MAIL: luisgarciafactura@gmail.com
NUEVA ITALIA

NUEVA ITALIA

HERRAMIENTAS AVILA
AMBROSIO FIGUEROA #152
COL. CENTRO C.P. 61760
NUEVA ITALIA, MICHOACÁN
TEL: 425 140 47 87
E-MAIL: herramientasmugica@gmail.com

ZACAPU

FERRETERA CENTRAL DE ZACAPU
MADERO NORTE # 157
COL. CENTRO C.P. 58600
ZACAPU, MICHOACÁN
TEL: 436 363 03 10
FAX: 436 363 21 25
E-MAIL: ferrecen1@prodigy.net.mx

LA PIEDAD

EQUIPO Y MAQUINARIA DEL PACIFICO SUC. LA PIEDAD
ENRIQUE RAMÍREZ # 59
COL. JARDINES DEL CARMEN C.P. 59387
LA PIEDAD, MICHOACÁN
TEL: 352 153 05 25
E-MAIL: makita.lapiedad@gmail.com

LÁZARO CÁRDENAS

COPROSER
AV. JOSÉ MARÍA MORELOS # 24
COL. ZONA INDUSTRIAL C.P. 60950
LAZARO CARDENAS, MICHOACÁN
TEL: 753 532 25 75
FAX: 753 532 09 78
E-MAIL: alexorozcoa@yahoo.com

ZAMORA

HERRAMIENTAS ELÉCTRICAS DE ZAMORA
AV. 5 DE MAYO #80 SUR
COL. CENTRO, C.P. 59600
ZAMORA, MICHOACÁN
TEL: 351 520 9432
E-MAIL: hmientasdz2902@hotmail.com

MORELOS

CUERNAVACA

GENERAL EN HERRAMIENTA Y SERVICIO
MARIANO MATAMOROS #77
COL. CENTRO C.P. 62000
CUERNAVACA MORELOS
TEL: 777 312 1,8 55
E-MAIL: ghsmorelos@hotmail.com

JIUTEPEC

CAMIR, LA CASA DE LA HERRAMIENTA
AVENIDA PASEO CUAUHNAHUAC KM. 3.5
COL. BUGAMBILIAS C.P. 62577
JIUTEPEC, MORELOS
TEL: 777 513 7194
E-MAIL: supercharlycuatro@outlook.com

TALQUITENANGO

MAQUINARIA TLAHUICA
AV. MORELOS # 60
COL. CENTRO C.P. 62980
TLALQUITENANGO, MORELOS
TEL: 734 342 38 16 / 342 13 50
E-MAIL: ventas_maquinariatlahuica@hotmail.com

CUAUTLA

SERVICIO Y HERRAMIENTAS CUAUTLA
CARRETERA FEDERAL CUAUTLA-MEXICO # 1617
COL. NUEVA POSTAL, C.P. 62750
CUAUTLA, MORELOS
TEL: 735 398 59 43
E-MAIL: shcuautla@hotmail.com

NAYARIT

HERRAMIENTAS TEPEC
BLVD. TEPEC-XALISCO #650
COL. MIRAVALLAS C.P. 63184
TEPEC, NAYARIT
TEL: 311 211 42 42
CEL: 311 121 64 36
E-MAIL: herramientasxalisco@hotmail.com

FERREANEL

CARRETERA TEPEC VTA KM 274
RINCÓN DE GUAYABITOS CP.63727
COMPOSTELA, NAYARIT
TEL: 31 1256 0375 / 32 7274 1829
E-MAIL: cesarlogo@gmail.com

NUEVO LEÓN

APODACA

COMERCIALIZADORA DIAJOSA
CARRETERA APODACA JUAREZ #505
COL. LOMAS DE LA PAZ, C.P. 66648
APODACA, NUEVO LEÓN
TEL: 811 772 67 52
E-MAIL: jonatan.cazares@diajosa.com.mx

MONTERREY

ABASTECEDORA LEAL
DR. COSS # 3330 NORTE
ENTRE DAVID A. COSIO Y RAFAEL DE LA PEÑA
COL. DEL NORTE C.P. 64500
MONTERREY, NUEVO LEÓN
TEL: 818 351 10 11 / 351 10 91 / 351 20 30
E-MAIL: abasleal@abasleal.com.mx

AUTOGENA Y ELÉCTRICA DEL NORTE

AV. FCO. I MADERO PTE. # 1148
COL. CENTRO C.P. 64000
MONTERREY, NUEVO LEÓN
TEL: 818 375 13 04 / 372 13 21
FAX: 818 372 88 51
E-MAIL: contacto@autogenayelectrica.com

CENTRO DE HERRAMIENTAS Y SERVICIO

EDISON # 907 NORTE
COL CENTRO C.P. 64000
MONTERREY, NUEVO LEÓN
TEL: 81 348 17 75 / 346 42 00
FAX: 81 478 72 69
E-MAIL: cen_her@prodigy.net.mx

HIGHCOLOR

BERNARDO REYES # 4217 NORTE
COL. NIÑO ARTILLERO C.P.64280
MONTERREY NUEVO LEON
TEL: 818 771 11 12
E-MAIL: ernesto.rodriguez@alcon.com.mx

TECHNOABRASIVOS

AV. FRANCISCO I. MADERO #846 PTE
COL. CENTRO C.P. 64000
MONTERREY, NUEVO LEÓN
TEL: 811 066 68 91
E-MAIL: alejandro8731@hotmail.com



ROMPEDORAS Y COMPACTADORAS S.A. DE C.V.

DIEGO DE MONTEMAYOR NTE. # 1010,
COL. CENTRO C.P. 64000
MONTERREY, NUEVO LEÓN
TEL: 811 969 03 90
E-MAIL: info@rompedoras.com
GUADALUPE

AIR WELDING

PROL. RUIZ CORTINEZ # 801 OTE
COL. VILLA DE SAN MIGUEL C.P. 67110
GUADALUPE, NUEVO LEÓN
TEL: 818 364 51 81 / 364 41 46
E-MAIL: ventas@airwelding.mx

SAN NICOLAS DE LOS GARZA

AFMTY FERREYTERIAS

AV. SANTO DOMINGO # 906
COL. LAS FUENTES 4TO SECTOR C.P. 66460
SAN NICOLAS DE LA GARZA, NUEVO LEÓN.
TEL: 8127 21 90 82 / 8127 21 90 83
EMAIL: csafmty@afmty.com.mx

OAXACA

OAXACA

IMPLEMENTOS FORESTALES DEL SURESTE

VALERIO TRUJANO # 707
COL. CENTRO C.P.68000
OAXACA DE JUÁREZ, OAXACA
TEL: 951 514 85 08 / 514 85 07/ 516 12 60
FAX: 951 514 85 09
E-MAIL: ifssa@prodigy.net.mx

MAKISERV OAXACA

SIMBOLOS PATRIOS # 911
COL. ELISEO JIMÉNEZ RUIZ, C.P. 71230
OAXACA DE JUÁREZ, OAXACA
TEL: 951 206 14 19
E-MAIL: makiserv_oax@live.com.mx

LA ASUNCIÓN FERRETERIA Y MADERERIA

CARRETERA INTERNACIONAL # 1814
COL. SANTA LUCIA DEL CAMINO, C.P. 71228
OAXACA DE JUÁREZ, OAXACA
TEL: 951 515 94 45
E-MAIL: servicio@lobus.com.mx

MIAHUATLÁN

FIX-IP FERRETERIA URBANA

BASILIO ROJAS # 304
COL. CENTRO C.P. 70800
MIAHUATLÁN, OAXACA
TEL: 951 572 13 38
E-MAIL: ferre_pinacho@hotmail.com

TUXTEPEC

CENTRO DE SERVICIO LOS ANGELES

AV. 5 DE MAYO # 1613
COL. CENTRO C.P. 68310
TUXTEPEC, OAXACA
TEL: 287 871 06 73 / 88 326 97
E-MAIL: losangeles.fac@gmail.com
ffrds@hotmail.com

PUERTO ESCONDIDO

DELTA INDUSTRIAL PUERTO ESCONDIDO

3RA. PONIENTE #504 ENTRE 5TA. Y 6TA. NORTEX
COL. SECTOR JUAREZ C.P. 71984
PUERTO ESCONDIDO, OAXACA
TEL: 954 104 22 93
E-MAIL: delta_refacciones@hotmail.com

SAN PEDRO POCHUTLA

DELTA INDUSTRIAL POCHUTLA

AV. LAZARO CARDENAS # 258
COL. CENTRO C.P. 70900
SAN PEDRO POCHUTLA, OAXACA
TEL: 958 584 90 38
E-MAIL: deltaindustrial.pochutla@hotmail.com
HUATULCO

STAR HERRAMIENTAS

BOULEVARD BAHÍAS # 32 FRACCIONAMIENTO COYULA
COL. SECTOR U2 C.P. 70980
BAHIA DE SANTA CRUZ (HUATULCO), OAXACA
TEL: 958 587 05 63 / 958 112 12 52
E-MAIL: starherramientas@gmail.com

SALINA CRUZ

HERRAMIENTAS DEL ITSMO

CAMINO VIEJO A LA VENTOSA # 4
COL. HILDALGO ORIENTE C.P. 70610
SALINA CRUZ, OAXACA
TEL: 971 725 15 52
E-MAIL: makitaherramientas@gmail.com

PUEBLA

PUEBLA

FERRE PAT DE PUEBLA

8 PONIENTE # 909 ENTRE LA 9 Y 11 NORTE
COL. CENTRO C.P. 72000
PUEBLA, PUEBLA
TEL: 222 246 50 34 / 242 41 42
E-MAIL: eduardovasquez@ferrepat.com

CREAR HOGAR

BLVD. NORTE Y BLVD. HERMANOS SERDÁN
COL. AMOR C.P. 72140
PUEBLA, PUEBLA
TEL: 222 248 37 59 / 249 39 04 EXT TALLER 106
FAX: 222 248 60 46
E-MAIL: crearhogar@prodigy.net.mx

TODO SERVICIO Y HERRAMIENTAS

30 PONIENTE # 2540 LOCAL 2
COL. AURORA C.P. 72070
PUEBLA, PUEBLA
TEL: 222 298 25 06 / 298 25 07
E-MAIL: makitapuebla@prodigy.net.mx

IMPLEMENTOS FORESTALES DEL SURESTE

17 PONIENTE # 2114
COL. RIVERAS DE SANTIAGO C.P.72480
PUEBLA, PUEBLA
TEL: 222 243 07 51
E-MAIL: ifsa_puebla@hotmail.com

AVM TOOLS

DIAGONAL DEFENSORES DE LA REPUBLICA #318
COL. LÁZARO CÁRDENAS C.P.72080
PUEBLA, PUEBLA
TEL: 222 651 65 38
E-MAIL: avmtools410@gmail.com.mx

GENERAL EN HERRAMIENTAS Y SERVICIO

17 NTE. ESQ. 4 PTE.
COL. CENTRO C.P. 72000
PUEBLA, PUEBLA
TEL: 222 246 50 67 / 246 37 26
E-MAIL: ghsventaspuebla@gmail.com

SAN PEDRO CHOLULA

HERRAMIENTAS PROFESIONALES.

CALLE 9 PONIENTE # 1308
COL. SAN PEDRO CHOLULA, C.P. 72762
SAN PEDRO CHOLULA, PUEBLA
TEL: 55 6460 63 77
EMAIL: josemanuel.lima@grupohfiores.com

CHIPILO

BLACK TOOLS

AV. 5 DE MAYO # 610 LT. 9 COL. CENTRO
C.P. 74325 CHIPILO, PUEBLA
TEL: (222) 283 10 78
E-MAIL: blacktools3410@hotmail.com
TEHUACÁN

EL FERRETERO

AV. INDEPENDENCIA OTE. # 502-A
COL. CENTRO C.P. 75700
TEHUACÁN, PUEBLA
TEL: 238 371 77 81
E-MAIL: ferretero13@live.com.mx

FERRE PAT

CALLE 3 SUR #535 ESQ. PEDRO DEL VALLE
COL. DEL EMPLEADO C.P 75700
TEHUACÁN, PUEBLA
TEL: 238 382 62 44 /384 67 90
E-MAIL: roberto.martinez@ferrepat.com

SAN JOSÉ ALCHICHICA

DITORSA

CARRETERA FEDERAL MÉXICO VERACRUZ S/N
COL. CENTRO C.P 73996 SAN JOSÉ ALCHICHICA
MUNICIPIO DE TEPEYAHUALCO, PUEBLA
TEL: 282 832 00 01 / 832 03 27
E-MAIL: ditorsaalchichica@hotmail.com

QUERÉTARO

QUERÉTARO

HERRAMIENTAS Y REPARACIONES INDUSTRIALES

CORREGIDORA # 977
COL.VILLAS DEL PARQUE C.P. 76169
QUERÉTERO, QUERÉTARO
TEL: 442 220 86 96 / 220 77 74 / 220 79 32
E-MAIL: hyrisadecv@gmail.com

HERRAMIENTAS REFACCIONES Y ACCESORIOS

CALLE GONZALO RIO ARRONTE # 9
COL. VILLAS DEL SUR C.P. 76040
QUERÉTERO, QUERÉTARO
TEL: 442 295 35 92 / 388 80 69
E-MAIL: herreyace@gmail.com, contacto@herreyace.com

HERRAMIENTAS Y REPARACIONES ALVÁREZ

AVENIDA RIO AYUTLA # 58
COL. LA PIEDAD C.P. 76150
QUERÉTERO, QUERÉTARO
TEL: 442 242 92 16
E-MAIL:herramientasyreparacionesalvarez@hotmail.com

4 TOOLS FERRETERIAS

PLAZA BELEA COLINAS DEL CIMATARIO # 415 LOCAL-B
COL. COLINAS DEL CIMATARIO
C.P. 76090, QUERÉTERO, QUERÉTARO
TEL: 442 455 14 14
E-MAIL: ventas@4tools.com.mx

SAN JUAN DEL RIO

HERRAMIENTAS Y SERVICIOS INDUSTRIALES

AV. LOMAS DE SAN JUAN # 102
COL. LOMAS DE SAN JUAN C.P. 76806
SAN JUAN DEL RIO, QUERÉTARO
TEL: 427 274 45 96
E-MAIL: herramientas.123@hotmail.com

HERRAMIENTAS Y REPARACIONES AL

AV.CONSTITUYENTES # 14 COL. BARRIO SAN ISIDRO, C.P.
76803 SAN JUAN DEL RIO, QUERÉTARO
TEL: (427 101 31 38 / CEL 414 219 50 65
E-MAIL: herramientasal@hotmail.com





TEQUISQUIAPAN

HERRAMIENTAS Y REPARACIONES TX
AQUILES SERDAN # 32
COL. ADOLFO LOPEZ MATEOS C.P. 76750
TEQUISQUIAPAN, QUERÉTARO
TEL: 414 273 25 63
E-MAIL: herramientasyserv-tx@hotmail.com

QUINTANA ROO

CANCÚN

REALSA CANCÚN
AV. TORCASITA Y JOSÉ LUIS PORTILLO,
SM 69 MZ.1 LOTES 28 AL 30 C.P. 77510
CANCÚN, QUINTANA ROO
TEL: 998 887 52 99 / 884 72 27 / 887 33 86
E-MAIL: administracion@gruporealsa.com

MAQUINARIA LIGERA PARA LA CONSTRUCCIÓN (CANCÚN)

AV. 127 MZ. #104 LT 16 ESQ. CALLE 20
COL. REGION CIEN C.P. 77518
CANCÚN, QUINTANA ROO
TEL: 998 146 05 02
maquinariialigerap.construccioncancun@hotmail.com

PLAYA DEL CARMEN

MAQUINARIA LIGERA PARA LA CONSTRUCCIÓN (PLAYA DEL CARMEN)

AV. JUÁREZ MZ 219 LT 4 ENTRE 55 Y 60
COL. EJIDO C.P. 77710
PLAYA DEL CARMEN, QUINTANA ROO
TEL: 984 110 51 14
maquinariialigerap.construccionplaya@hotmail.com

MATERIALES EL UNICORNIO

AV. 115 NORTE MZ. 182 LT. 7 POR CALLE 28
COL. EJIDO C.P. 77710
PLAYA DEL CARMEN, QUINTANA ROO
TEL: 984 803 95 96 / 803 95 75
E-MAIL: ventas@materialeselunicornio.com.mx

LEMA HERRAMIENTAS

AV. JUÁREZ MZ.211 LT.12 ENTRE 60 Y 70
COL. EJIDO C.P.77710
PLAYA DEL CARMEN, QUINTANA ROO
TEL: 984 206 23 18 / 733 33 50
E-MAIL: lemah_pdc@hotmail.com

TULUM

HERRAMIENTAS LYDAN

XCARET NORTE, ENTRE CALLE SAGITARIO ORIENTE Y AV.
TULA ORIENTE LOCAL 2
COL. REGION CERO DIEZ, C.P. 77760
TULUM, QUINTANA ROO
TEL: 998 561 16 72
E-MAIL: admon.lydan@hotmail.com

CHETUMAL

REFACCIONES, EQUIPOS Y SERVICIOS FC

VENUSTIANO CARRANZA # 242
ESQ. INDEPENDENCIA
COL. VENUSTIANO CARRANZA C.P. 77012
CHETUMAL, QUINTANA ROO
TEL: 983 832 13 84 / 832 12 95
E-MAIL: servicio@gfcontinental.com

SAN LUIS POTOSÍ

GRUPO HICA

AV. JOAQUÍN ANTONIO PEÑALOSA # 316
COL. EL PASEO C.P. 78320
SAN LUIS POTOSÍ, SAN LUIS POTOSÍ
TEL: 444 816 31 46 / 818 02 94
E-MAIL: mostrador@grupohica.com.mx
serviciomakita@grupohica.com.mx

CIFERIN

5 DE MAYO # 2375
COL. FRACC. VILLA RICA C.P. 78360
SAN LUIS POTOSÍ, SAN LUIS POTOSÍ
TEL: 444 820 73 72 / 820 29 08 / 129 42 21
E-MAIL: joel.hb@hotmail.com

SINALOA

CULIACAN

SERVIMAK HERRAMIENTAS (PALMITO)

BLVD. EMILIANO ZAPATA # 2590
COL. EL PALMITO C.P. 80110
CULIACÁN, SINALOA
TEL: 667 455 11 65
E-MAIL: servimakherramientas@outlook.com
LOS MOCHIS

DO IT CENTER

(FIERRO Y LAMINAS DE LOS MOCHIS)

JUÁREZ ESQ. ZARAGOZA
COL. CENTRO C.P. 81200
LOS MOCHIS, SINALOA
TEL: 668 812 02 81 / 112 02 81 / 812 52 06
E-MAIL: ventas@doitcenter.com.mx

BABATSA

AV. INDEPENDENCIA # 1338
COL. FRACC JARDINES DEL VALLE C.P. 81245
LOS MOCHIS, SINALOA
TEL: 668 815 20 80
E-MAIL: gerencia.independencia@babatsa.com.mx

GRUPO REOC

BLVD. JIQUILPAN 2023 LOCAL 2
COL. LOS SAUCES C.P. 81247
LOS MOCHIS, SINALOA
TEL: 668 618 55 68
E-MAIL: gruporeoc@gmail.com

MAZATLÁN

SERHSI

RAFAEL BUELNA # 928 INT. 1
COL. SANCHEZ CELIS C.P. 82120
MAZATLÁN, SINALOA
TEL: 669 112 12 75
E-MAIL: ventas@serhsi.com
roxana.crespo@serhsi.com

GUAMUCHIL

RENTAMEX

FRANCISCO LABASTIDA OCHOA # 15
COL. MAGISTERIO C.P. 81470
GUAMUCHIL, SINALOA
TEL: 673 732 41 30
E-MAIL: elremateguamuchil1@outlook.es

GUASAVE

GRUPO REOC

AV JUAN CARRASCO # 294
COL. CENTRO C.P. 81000
GUASAVE, SINALOA
TEL: 687 131 18 25
E-MAIL: gruporeoc@gmail.com

SONORA

HERMOSILLO

SOLDADURA, EQUIPO Y CONSTRUCCIÓN

NAYARIT # 217 ENTRE REFORMA
Y GPE. VICTORIA
COL. SAN BENITO C.P. 83190
HERMOSILLO, SONORA
TEL: 662 210 25 00 FAX: 662 210 25 50
E-MAIL: secsaherramientas@prodigy.net.mx

SIS Y GASES DE HERMOSILLO

C. AYUNTAMIENTO ESQ. PERIFERICO NORTE #583
COL. CHOYAL C.P. 83130
HERMOSILLO SONORA
TEL: 662 313 24 95 / 381 62 02
E-MAIL: servicioclientes@sisygases.com.mx

HSO HERRAMIENTAS Y SERVICIOS (HERMOSILLO)

BLVD. AGUSTÍN DE VIDOSOLA # 300
COL. PEDREGAL DE LA VILLA C.P. 83290
HERMOSILLO, SONORA
TEL: 662 250 60 10
E-MAIL: luispadilla@hso.com.mx

CIUDAD OBREGÓN

SIS Y GASES DE CAJEME

JACINTO LÓPEZ 401 PTE.
COL. FAUSTINO FELIX C.P. 85180
CIUDAD OBREGÓN, SONORA
TEL: 644 417 68 80 / 417 09 08
E-MAIL: estebanlagarda@hotmail.com

HSO HERRAMIENTAS Y SERVICIOS (OBREGÓN)

DR. NORMAN E BORTAUG # 2605 SUR
COL. MUNICIPIO LIBRE C.P. 85080
CD. OBREGÓN, SONORA
TEL: 644 417 11 95 TALLER EXT 112
E-MAIL: compras2@hso.com.mx

SAN LUIS RÍO COLORADO

FETASA RÍO COLORADO

AV. NAYARIT Y CALLE 26 #2510
COL. JALISCO C.P. 83447
SAN LUIS RÍO COLORADO, SONORA
TEL: 653 534 57 53 / 534 96 97 / 535 62 02
E-MAIL: acofetasa@yahoo.com.mx

PUERTO PEÑASCO

TODO PARA EL CARPINTERO

AV. TECLA DE BUSTAMANTE S/N ESQ. LEÓN DE LA BARRA
COL. ORIENTE C.P. 83550
PUERTO PEÑASCO, SONORA
TEL: 638 383 10 01 / 388 64 66
FAX: 638 383 10 01
E-MAIL: todo_para_el_carpintero@prodigy.net.mx

SECSA PEÑASCO

ADOLFO LÓPEZ MATEOS Y JUSTO SIERRA # 219
COL. CENTRO C.P. 83550
PUERTO PEÑASCO, SONORA
Tel: 638 388 67 88 / FAX: 388 67 89
E-MAIL: secsapenasco@prodigy.net.mx,
ventaspp@secsatools.com.mx

NOGALES

IGC ACCESORIOS Y REFACCIONES

AV. DE LOS NOGALES # 277 LOCAL 12
COL. SAN CARLOS, C.P. 84090
NOGALES, SONORA
TEL: 631 315 73 13
E-MAIL: ivangalvezchavarria@gmail.com

GUAYMAS

ESINSA SEGURIDAD INDUSTRIAL

CARRETERA INTERNACIONAL. # 1037 A
COL. PETROLERA C.P. 85456
GUAYMAS, SONORA
TEL: 622 222 97 76 / 222 97 77
E-MAIL: esinsa@hotmail.com

**TABASCO****VILLAHERMOSA****REALSA VILLAHERMOSA**

AV. CONSTITUCIÓN # 516
COL. CENTRO C.P. 86000
VILLAHERMOSA, TABASCO
TEL: 993 312 53 17
E-MAIL: ventasv1@gruporealsa.com

MERSOL SURESTE

AV. RUIZ CORTÍNEZ # 2001-B COL. ATASTA C.P. 86100
VILLAHERMOSA, TABASCO
TEL: 993161 44 79 / 161 48 20
E-MAIL: servicio.tecnico@mersolsureste.com.mx

TAMAULIPAS**REYNOSA****STEEL MART MERCADO DE ACERO**

HERON RAMIREZ # 1445
COL. RODRÍGUEZ C.P. 88630
REYNOSA, TAMAULIPAS
TEL: 899 909 50 00
E-MAIL: makita@steelmart.com.mx

TAMPICO**CF ANCLAJE Y HERRAMIENTAS**

CARRETERA TAMPICO MANTE # 501-B
COL. FCO. JAVIER MI NA C.P. 89318
TAMPICO, TAMAULIPAS
TEL: 833 226 47 82 / 226 31 51
E-MAIL: cfanclajeyherramientas@gmail.com
cfanclajenorte@prodigy.net.mx

CIUDAD MADERO**INGENIEROS Y TECNICOS ASOCIADOS**

NECAXA # 513 NORTE,
COL. FELIPE CARRILLO PUERTO C.P. 89430
CD. MADERO, TAMAULIPAS
TEL: 833 216 82 16 / 221 34 50
E-MAIL: fernandogonzalez@prodigy.net.mx

CIUDAD VICTORIA**FERRETERIA Y SOLDADURAS VICTORIA**

AIRE 2002, COL. COMERCIAL 2000, C.P. 87099
CIUDAD VICTORIA, TAMAULIPAS
TEL: 834 31 612 12 / 30 88 080
E-MAIL: fesovisa@prodigy.net.mx

MATAMOROS**DISTRIBUIDORA DE HERRAMIENTAS Y REFACCIONES**

PROFESOR MANUEL ROMERO # 105
COL. INDUSTRIAL C.P. 87350
MATAMOROS, TAMAULIPAS
TEL: 868 812 30 50 / 868 812 30 30
E-MAIL: ventas@diheresa.com

NUEVO LAREDO**MAYOREO FERRETERO ELIZONDO**

AYUNTAMIENTO No. 107 ENTRE CALLES AV. BENITO JUA-
REZ Y PRIV ESCOBEDO; COL. LOS ELIZONDO C.P. 66050
NUEVO LAREDO, TAMAULIPAS
TEL: 818 058 15 50
E-MAIL: mfe@mehardware.com

ALTAMIRA**CARDENAS RIOS JOSE WILFREDO**

CORONEL TRILLO #500-A
COL. INDUSTRIAL GUERRERO C.P. 89603
ALTAMIRA TAMAULIPAS
TEL: 833 264 40 83
E-MAIL: wcardenas.hysa@hotmail.com

TLAXCALA**SERVICIO RUIZ**

CALLE 2 DE ABRIL # 508-A COL. CENTRO
C.P. 90300 APIZACO, TLAXCALA
TEL: 241 217 22 38
E-MAIL: makitatlaxcala@hotmail.com

VERACRUZ**VERACRUZ****MERCADO DE LA SOLDADURA DEL SURESTE**

AV. MIGUELLEMAN # 1145 ESQ. SANTOS PEREZ ABASCAL
COL. ORTIZ RUBIO C.P. 91750
VERACRUZ, VERACRUZ
TEL: 229 920 85 77 / 931 16 30
E-MAIL: admonveracruz@mersolsureste.com.mx

CORDOBA**HERRAMIENTAS Y MOTORES HANA (CORDOBA)**

AV. 3 # 1318-B
COL. CENTRO C.P. 94500
CORDOBA, VERACRUZ
TEL: 271 714 86 46 / 717 82 69
E-MAIL: alexandervalencia61@hotmail.com
tallermakita@hotmail.com

ORIZABA**HERRAMIENTAS Y MOTORES HANA (ORIZABA)**

NORTE 10 # 137 (ENTRE OTE. 3 Y 5)
COL. CENTRO C.P. 94300
ORIZABA, VERACRUZ
TEL: 272 724 51 38 WHATSAPP 272 170 55 40
E-MAIL: coti.makitaori@hotmail.com
COATZACOALCOS

COATZACOALCOS**INTERNACIONAL DEL GOLFO**

MORELOS # 507-B
COL. CENTRO C.P. 96400
COATZACOALCOS, VERACRUZ
TEL: 921 212 43 86 / 212 92 57
FAX: 921 212 55 14
E-MAIL: internacionaldelgolfo@prodigy.net.mx

XALAPA**MARQUEZ ESCOBAR HERMANOS**

SIMÓN BOLIVAR #54 COL. JOSÉ CARDEL, C.P. 91030
XALAPA, VERACRUZ
TEL: 228 815 27 79
E-MAIL: ferremarquez.ventas@hotmail.com

SAN RAFAEL**FECEGO**

DIAZ MIRON # 5 COL. CENTRO C.P. 93620
SAN RAFAEL, VERACRUZ
TEL: 232 324 90 60
E-MAIL: auribe.fecego@gmail.com

POZA RICA**FRAZA**

AV 6 NORTE # 8 COL. OBRERA C.P. 93260
POZA RICA, VERACRUZ
TEL: 782 823-2827 / 782 824-65-65
E-MAIL: frazapr@hotmail.com/contacto@frazza.com.mx
TANTOYUCA

SANVER FORTE

CARRETERA NACIONAL TUXPAN-TAMPICO KM 64
S/N, COL. LAMORITA, C.P. 92116
TANTOYUCA, VERACRUZ
TEL: 789 893 30 30
E-MAIL: compras5@sanver.com.mx

YUCATÁN**MERIDA****REALSA YUCATÁN**

CALLE 63 # 452-E (ENTRE 50 Y 52)
COL. CENTRO C.P. 97000
MERIDA, YUCATÁN
TEL: 999 924 01 20 / 924 89 07
E-MAIL: gabrielgonzalez@gruporealsa.com
realsa1@prodigy.net.mx

CASA FERNÁNDEZ DEL SURESTE SA DE CV

CALLE 60 # 547 ENTRE CALLES 69 Y 71
COL. CENTRO C.P. 97000
MERIDA, YUCATÁN
TEL: 999 923 77 71
E-MAIL: centrodeservicio@casafernandez.com

HERRAMIENTAS Y MAQUINARIA BURGOS

CALLE 48 # 487-E (ENTRE 51 Y 53)
COL. CENTRO C.P. 97000
MERIDA, YUCATÁN
TEL: 999 928 62 33
E-MAIL: costos@agroindustrialburgos.com

TIZIMIN**TUBOS NIPLES Y BOMBAS DEL ORIENTE**

CALLE 49-B ENTRE 44 Y 46 C.P. CENTRO
C.P. 97700 TIZIMIN, YUCATÁN
TEL: 986 863 28 02
E-MAIL: compras@tunboriente.com

ZACATECAS**ZACATECAS****METALS & SUPPLIES**

CALZADA UNIVERSIDAD # 202-A
COL. FRACC. PROGRESO C.P. 98066
ZACATECAS, ZACATECAS
TEL: (01492) 998 24 94 / 925 59 69
E-MAIL: l.flores@metals.com.mx
a.luevano@metals.com.mx

FRESNILLO**CENTAURUS MÁQUINAS Y HERRAMIENTAS**

JOYA # 10
COL. LA JOYA C.P. 99030
FRESNILLO, ZACATECAS
TEL: (01493) 878 15 15 / 878 06 90 EXT. 106
E-MAIL: admon_centauruzac@hotmail.com

VALPARAISO**MOTO SERVICIO ORTEGA**

HIDALGO # 224
COL. CENTRO C.P. 99250
VALPARAISO, ZACATECAS
TEL: (01457) 936 24 14
E-MAIL: richi_2410@hotmail.com



www.makita.com.mx



MakitaLatinAmerica



Makita_Mexico



MakitaMexicoOficial

