

**KOCOM CO.,LTD.**

**KOCOM®**

# COMBINED DOORPHONE

**KDP-602A/D** MANUAL FOR OPERATION AND INSTALLATION

## *Features*

- Can be used with direct interphone and doorphone
- Differentiated call signal to rooms and door station
- Used : home,office,apartment,factory,hospital etc.
- Can be combined with door opener.
- Can be used 1:interphone

Thank you very much  
for purchasing KOCOM  
Doorphone.  
please read this manual  
thoroughly to ensure  
correct usage,  
before operation

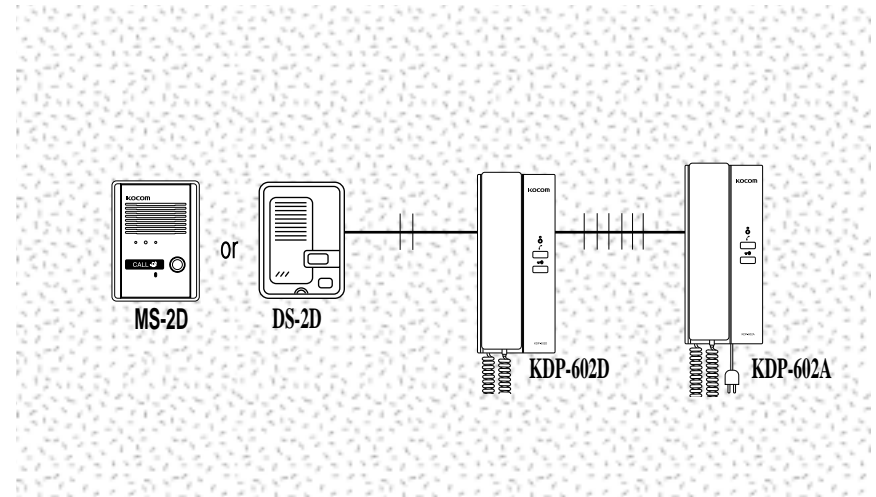

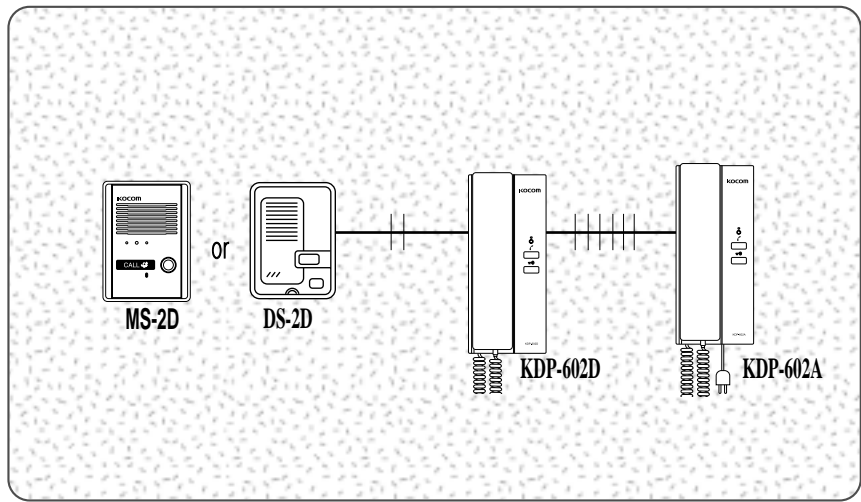

## How to operate (Instruction for operating)

### Doorphone function



When visitors push the outdoor station call button,

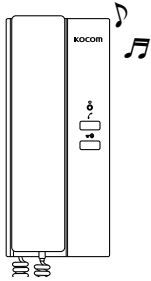

The indoor station 2pcs are ringing.

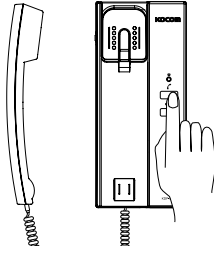

Pick up the handset, and push the "Door Key" button if you want to open the door.

### Interphone function

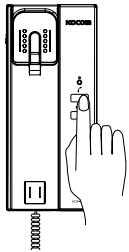

If you want to communicate with another indoor station, pick up the handset and push the "INT" button.

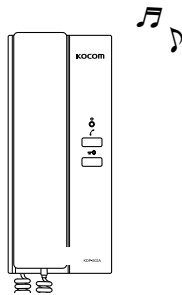

Another indoor station is ringing.

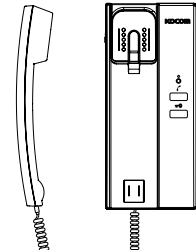

Pick up the handset, and you can communicate with another indoor station.

During communication between the outdoor station and the Interphone-1, if the interphone-1 wants to connect the interphone-2 with the outdoor station, push the hook button first and  of Interphone-1 to page the interphone-2.

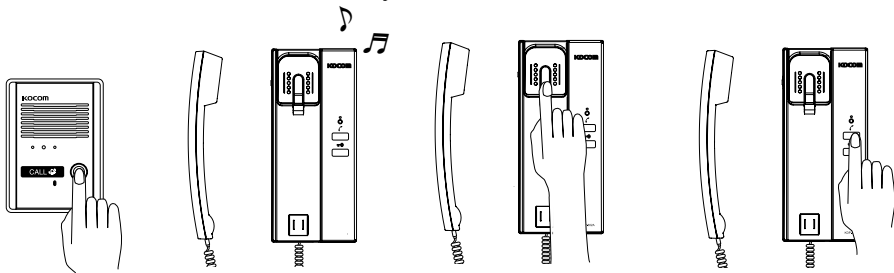

## Warranty



To receive after sales service, have the followings ready when you contact our branches

1. Name of the product
2. Model number of the product
3. The area of problem
4. Phone number and address at which you can be contacted.

## Warranty Card

PRODUCT	
MODEL	
DATE PURCHASED	
WARRANTY PERIOD	
AGENCY	
AGENCY ADDRESS	

◎ **KOCOM** Warranties the original purchaser of the product as follows.

- 1) This product is produced under strict quality control and inspection procedures.
- 2) If this product breaks down during proper use as a result of product defect, KOCOM will repair it within one year from date of purchase free of charge.
- 3) The following cases will be subject to charge, even during warranty period:
  - a. Breakdown during transport, or through careless treatment, by consumer.
  - b. Breakdown caused by unauthorized repair, or system modification.
  - c. Breakdown caused by natural disaster or power disorder.

## Precautions for Operation

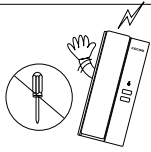

As this device consists of precise electronic components, and high voltage is generated internally, do not attempt to disassemble.

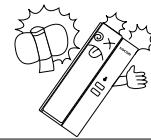

Do not drop Indoor or outdoor station, and avoid strong impact.



When cleaning, never use wet hands, volatile benzene or paint thinner.

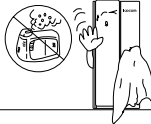

Keep away from humidifier and stove. High temperature and humidity can cause malfunction

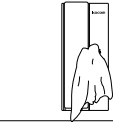

Maintain the product clean by frequently wiping outdoor with soft cloths

## Name of Each Part

### Indoor Station

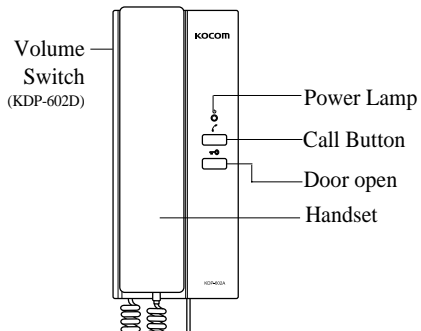

### Out door Station

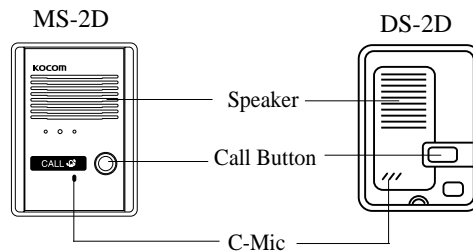

## Specifications

Description	KDP-602A
Electric source	AC 220V or AC110V
Consumption	UN LOAD: 1.3W, IN LOAD: 4W
Signal Sound	From door : chime , From indoor : Electronic Chime
Wiring	Door : 2Wired , Room : 6Wired
Range	KDP-602A ↔ KDP-602D = 30m KDP-602A or KDP-602D ↔ MS-2D or DS-2D = 50m

## Component

- Master station for Indoor-use
- Substation for Outdoor-use
- Wall hanger for master station

## Wiring Diagram

### Wiring diagram of between two Indoor stations and DS-2D outdoor station

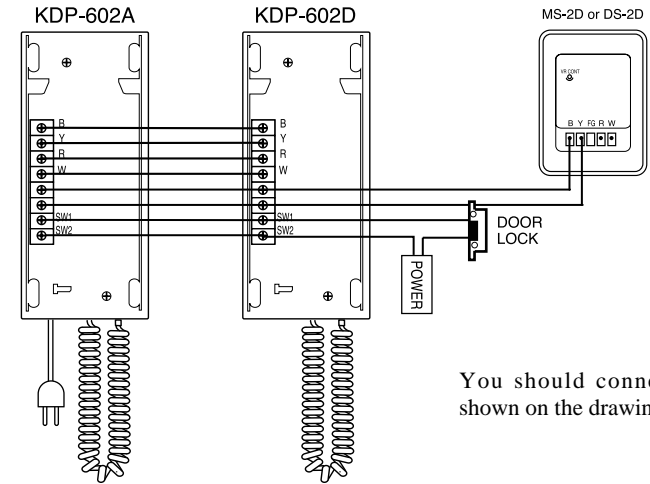

You should connect the wires as shown on the drawing

## Installation

### Installation of indoor station

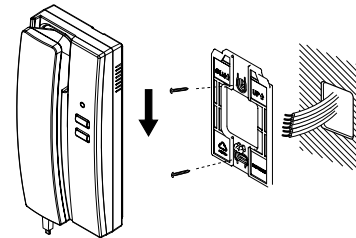

- A- Choose a place on the wall where you want to hang the DOOR PHONE.
- B- Fasten the wall hanger on the wall.
- C- DOOR PHONE can be hung on the wall hanger easily now.

### Installation of outdoor station

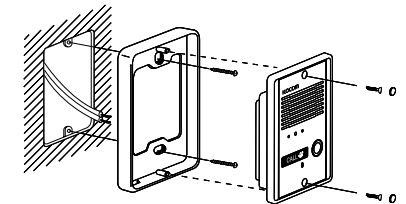

After attaching the body supporter with 2screws, put the Door Camera into the grooves of body supporter, and then fix it with screws.

Outdoor station can be attached on a wall or on a door as shown on the drawing.