



PRIMUS



THRÓNOS2005 | QUICK ASSEMBLY GUIDE

English

Thank you for purchasing this high-quality gaming chair from **Primus**. To ensure proper assembly and safe use of this product, please follow the instructions contained in this guide.

1. Box content

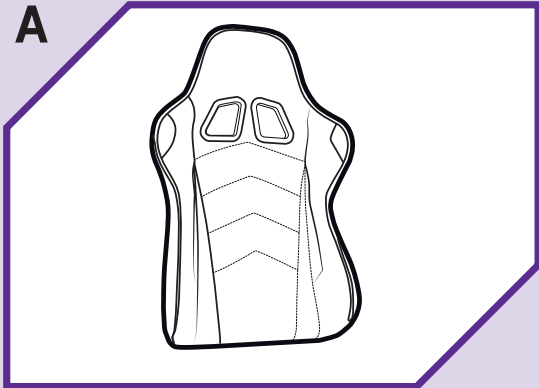

Back rest

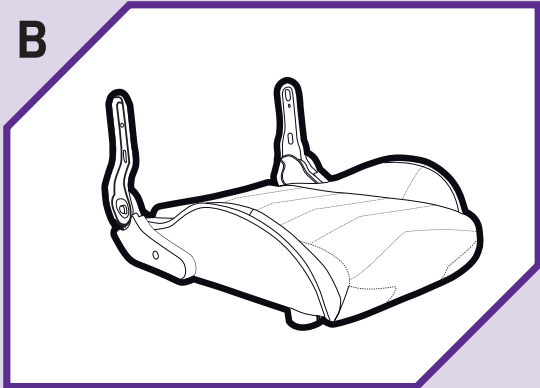

Seat cushion

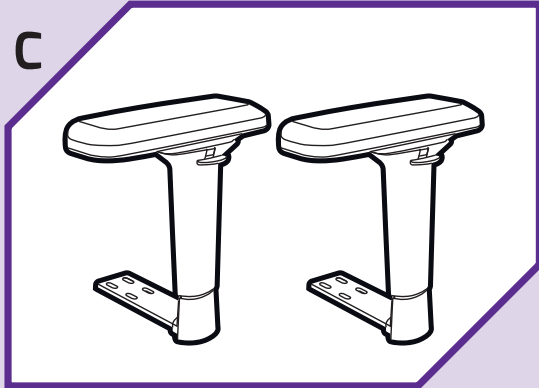

Armrests

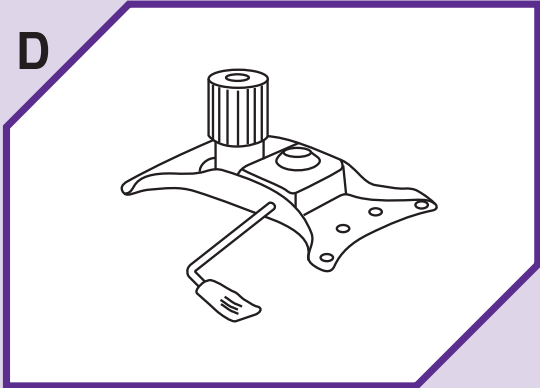

Mechanical base

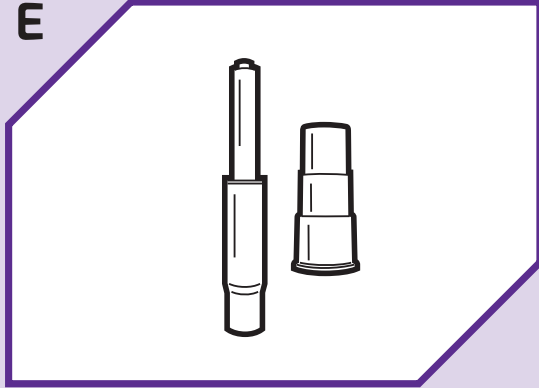

Gas lift cylinder with cover

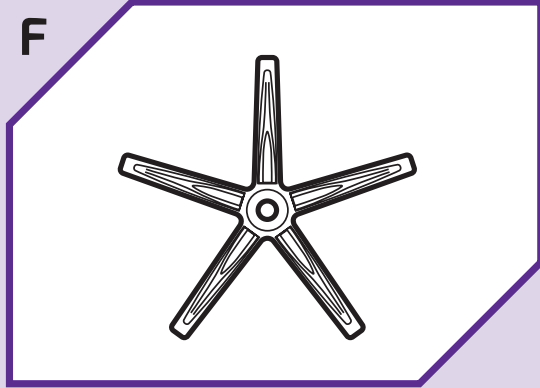

Base

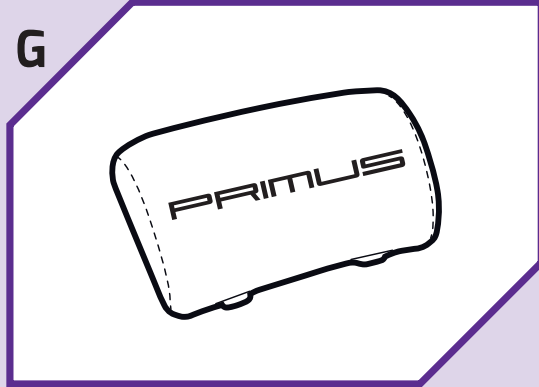

Lumbar pillow

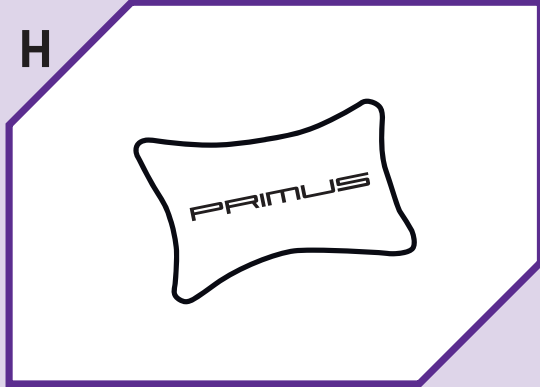

Headrest

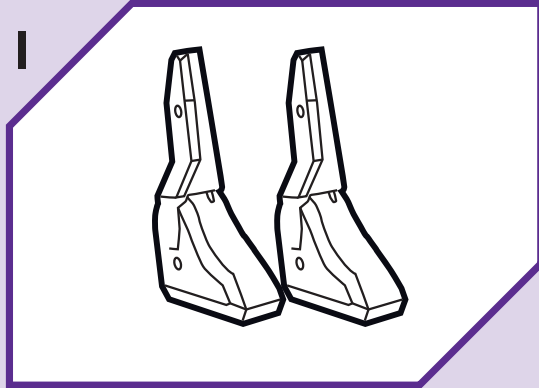

Left and right side covers

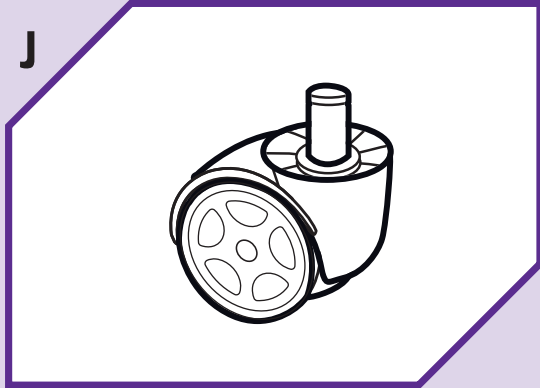

2.6in wheel (5)

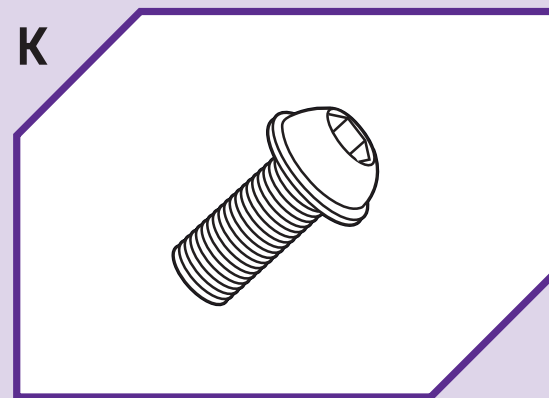

M8x20mm allen head screw (16)

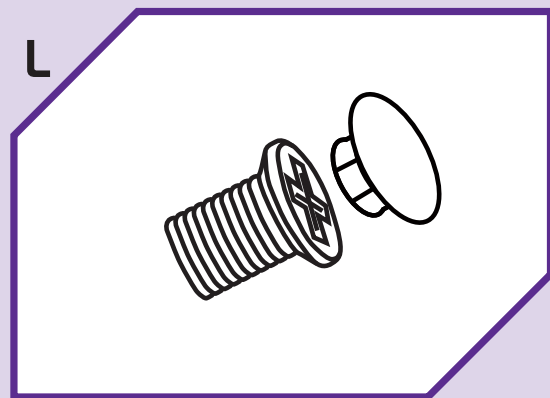

ST5x10mm screw (2) with caps

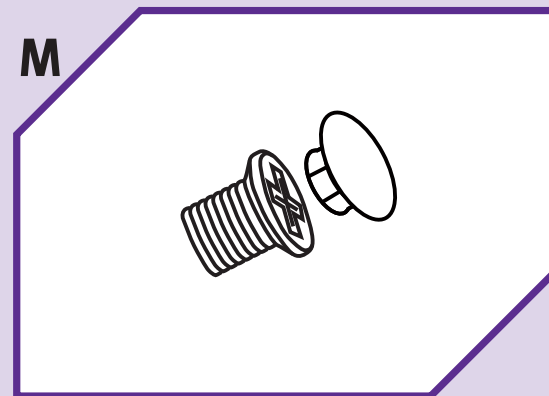

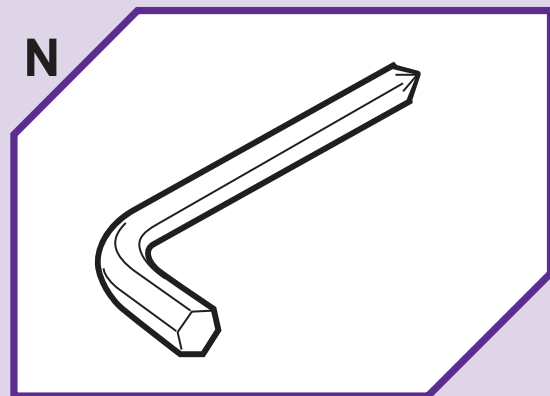

ST5x8mm screw (2) with caps



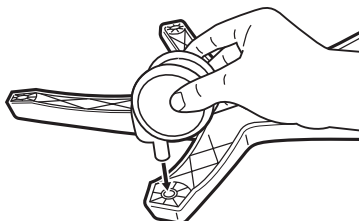

Allen wrench/Phillips screwdriver combination tool

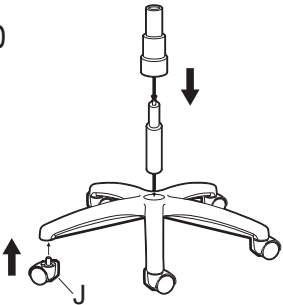
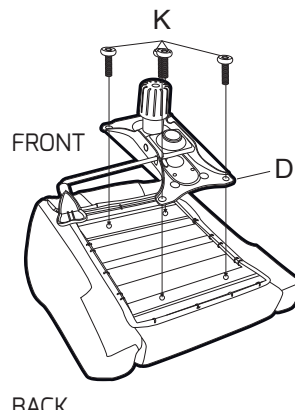
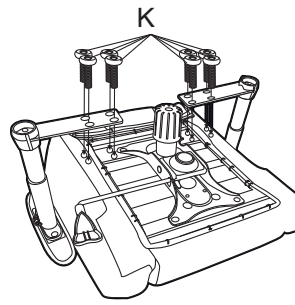
## 2. Assembly steps

Step	Description	Image
1	Start by attaching the five wheels into chair base. Simply press the stud firmly into the hole on the bottom of the base.	

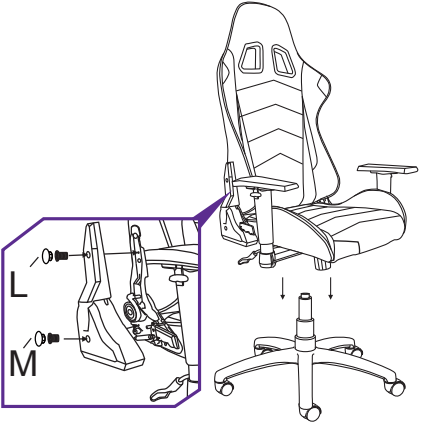
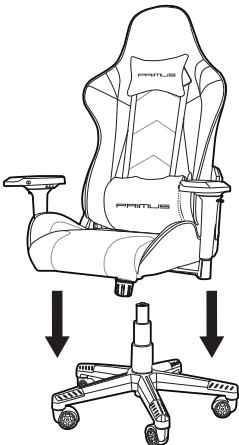
Step	Description	Image
2	Mount the gas lift and its cover into the top of the chair base by placing the larger end into the hole in the center.	
3	Proceed to attach the mechanical base to the seat assembly using four of the supplied M8x20mm screws.  <b>Note:</b> Make sure to follow the arrow direction for the frontal positioning of the base.	
4	Next, use eight M8x20mm screws to attach the right (R) and left (L) armrests to the seat assembly, as illustrated in the figure on the right.	
5	Attach the back rest to the seat cushion using four M8x20mm screws so as to fasten both sides of the chair.  Tighten the screws to firmly secure the back rest.	

Step	Description	Image
6	Use the supplied ST5x10mm and ST5x8mm screws to attach the plastic covers over the attachment points on both sides, between the seat cushion and the back rest.	
7	Attach the seat assembly to the base by sliding the center hole of the mechanical base over the gas lift cylinder.	
8	<p>To attach the headrest, run the straps through the two holes at the top and snap them together on the back of the chair.</p> <p>To attach the lumbar pillow, run the straps through the two holes at the top of the chair. The other two straps go between the seat cushion and back rest. They should snap together on the back of the chair.</p> <p>Adjust the height of the lumbar pillow and enjoy your new <b>Thrónos</b> chair.</p>	

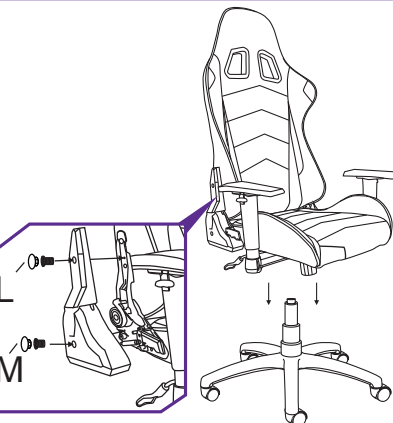
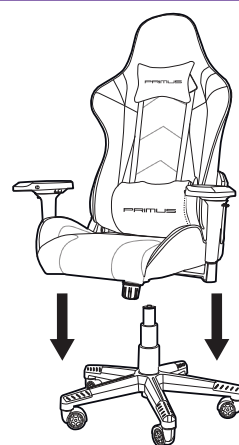
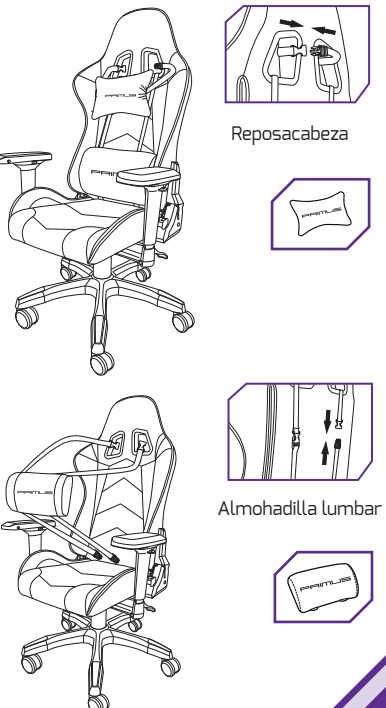
Paso	Descripción	Imagen
6	Use los tornillos ST5x10mm y ST5x8mm que se incluyen con el producto para fijar las cubiertas plásticas sobre los puntos de sujeción en ambos costados, entre el cojín del asiento y el respaldo.	
7	Una el conjunto del asiento a la base deslizando el orificio central de la base mecánica sobre el cilindro neumático de gas.	
8	<p>Para colocar el reposacabeza, pase las tiras por la parte superior y abróchelas por detrás del respaldo de la silla.</p> <p>Para colocar la almohadilla lumbar, pase las tiras por los orificios en la parte superior de la silla. Pase las otras dos tiras entre el cojín del asiento y el respaldo. Finalmente, abróchelas por detrás del respaldo de la silla.</p> <p>Ajuste la altura del cojín y disfrute la nueva silla <b>Thrónos</b> de Primus.</p>	

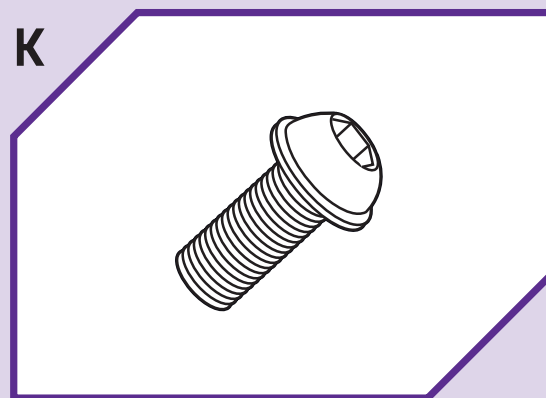

Tornillo allen M8x20mm (16)

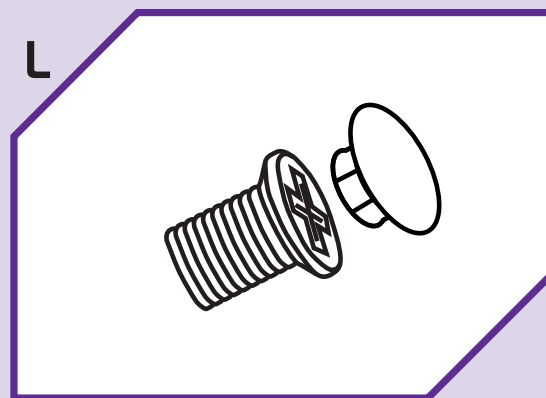

Tornillo autorroscante ST5x10mm (2) con tapa

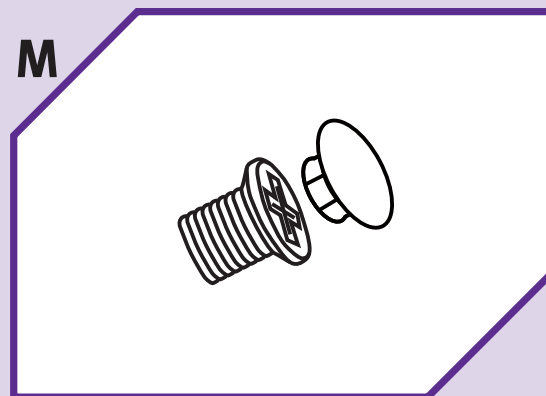

Tornillo autorroscante ST5x8mm (2) con tapa

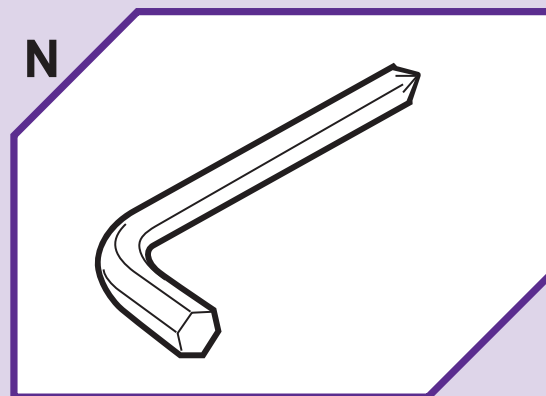

Llave de combinación con punta allen y phillips

## 2. Pasos para el ensamblaje

Paso	Descripción	Imagen
1	Comience por colocar las cinco ruedas a la base de la silla. Basta ejercer presión para insertar el perno en el orificio de la parte inferior de la base.	

Paso	Descripción	Imagen
2	Inserte el mecanismo neumático y la cubierta en la parte superior de la base de la silla colocando el extremo más grande en el orificio del centro.	
3	<p>Proceda a unir la base mecánica al conjunto de la silla usando cuatro de los tornillos M8x20mm suministrados.</p> <p><b>Nota:</b> Asegúrese de guiarse por la orientación de la flecha para identificar la sección frontal de la base.</p>	
4	<p>Use a continuación los ocho tornillos M8x20mm para unir el reposabrazo derecho (R) e izquierdo (L) al conjunto del asiento, tal como se ilustra en el recuadro de la derecha.</p>	
5	<p>Una el respaldo al cojín del asiento usando cuatro tornillos M8x20mm con el fin de fijarlos a ambos lados de la silla.</p> <p>Apriete los tornillos para asegurar firmemente el respaldo al asiento.</p>	

## Español

Gracias por preferir esta silla de excelente calidad para videojuegos de **Primus**. Para garantizar el debido ensamblaje y el uso seguro de este producto, le recomendamos seguir las instrucciones contenidas en la presente guía.

### 1. Contenido del empaque



Respaldo

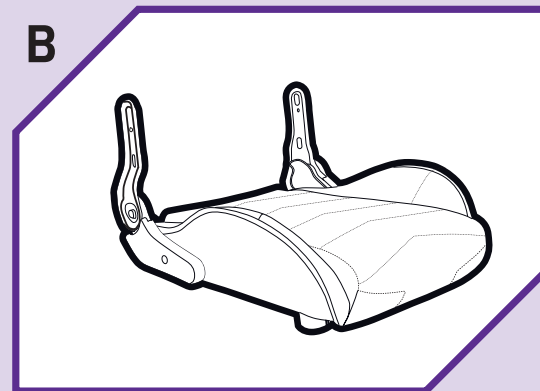

Cojín del asiento

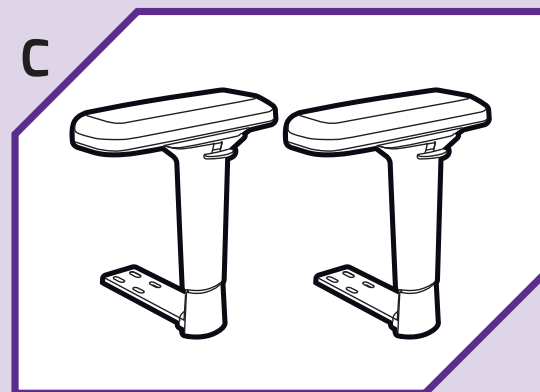

Reposabrazos

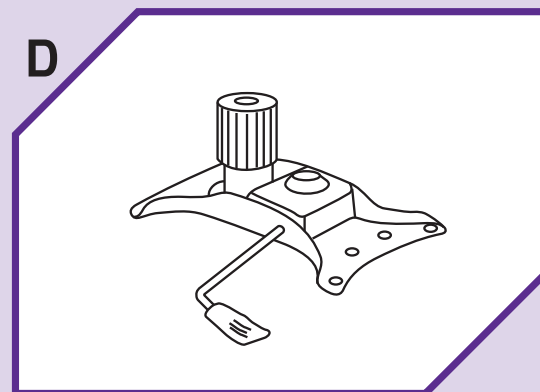

Base mecánica

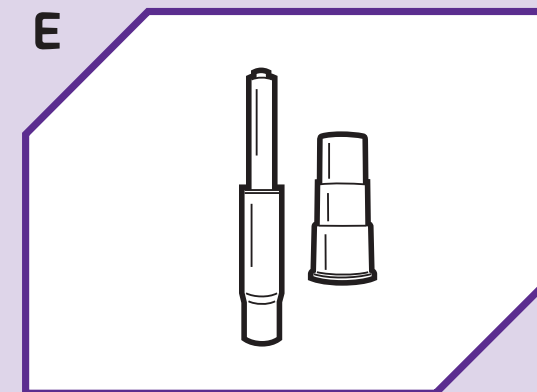

Cilindro neumático de elevación con cubierta

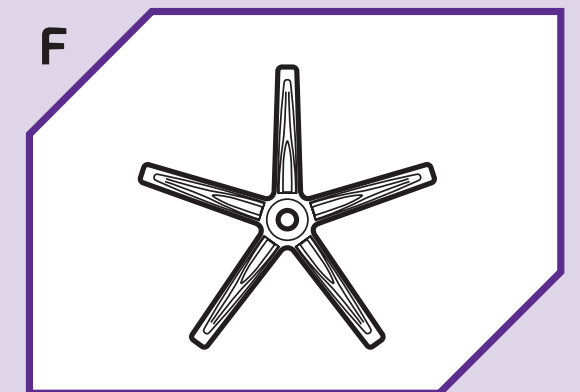

Base

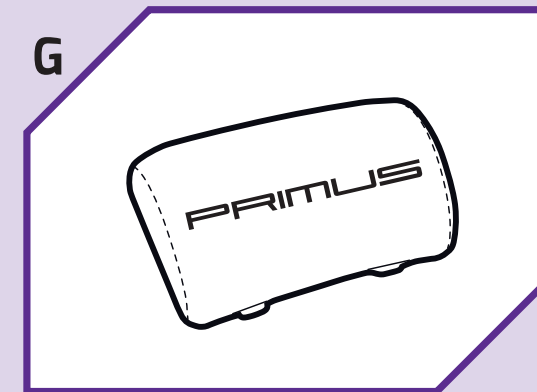

Almohadilla lumbar

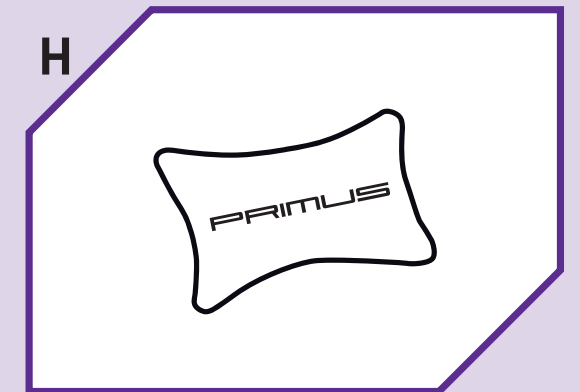

Reposacabeza

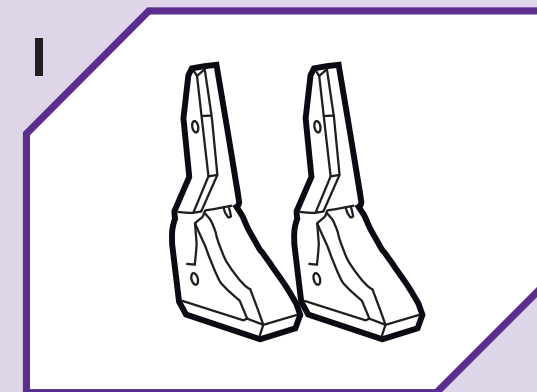

Tapas laterales derecha e izquierda

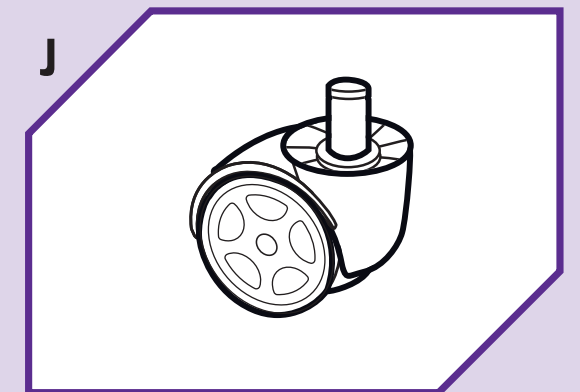

Rueda de 6cm (5)





PRIMUS



THRÓNOS2005

GUÍA DE ARMADO RÁPIDO