

1018A

V0.0

Soporte para pantallas de 25" a 50" MANUAL DE INSTRUCCIONES

IMPORTANTE

Antes de utilizar el producto, lea cuidadosamente este instructivo para evitar cualquier mal funcionamiento. La información presentada sirve únicamente como referencia sobre el producto. Debido a actualizaciones pueden existir diferencias. Consulte nuestra página web www.steren.com para obtener la versión más reciente de este manual.



• Este aparato no se destina para utilizarse por personas (incluyendo niños), cuyas capacidades físicas, sensoriales o mentales sean diferentes o estén reducidas, o carezcan de experiencia o conocimiento.

• Los niños deben supervisarse para asegurar que no empleen el aparato como juguete.



• Este producto está diseñado para uso en interiores.



• Elija una superficie sólida para poder fijar con seguridad el soporte.



• No exceda la capacidad de carga máxima (25 kg).

CONTENIDO

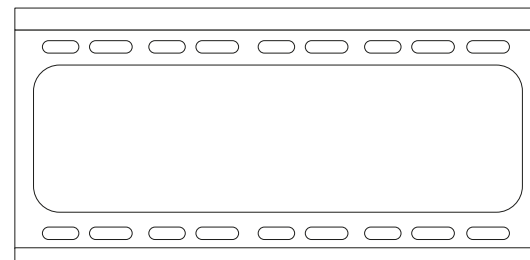

Soporte

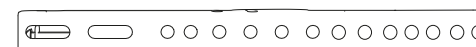

Barras de sujeción

KIT DE TORNILLOS Y RONDANAS

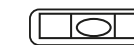
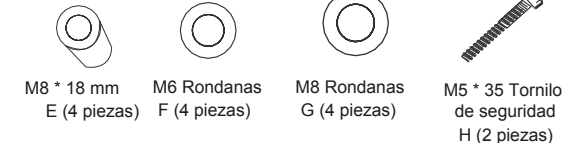
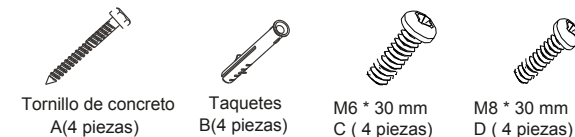

Nivelador de gota
I (1 pieza)

HERRAMIENTAS NECESARIAS

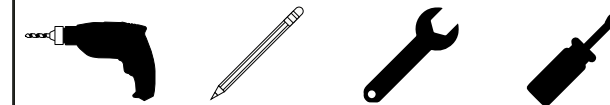

No incluidas

1. Utilice el soporte y el nivelador para realizar marcas de perforación sobre la superficie donde desea hacer la instalación. Después, perforo y coloque los tornillos como se muestra en la imagen.

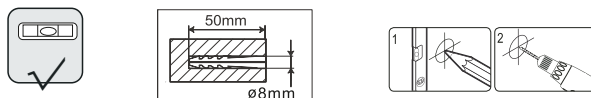

A) INSTALACIÓN en concreto

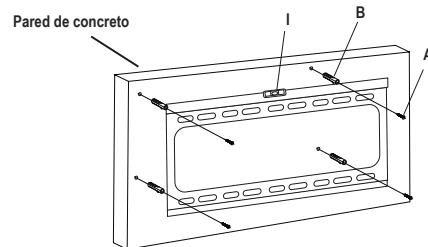

B) INSTALACIÓN en madera

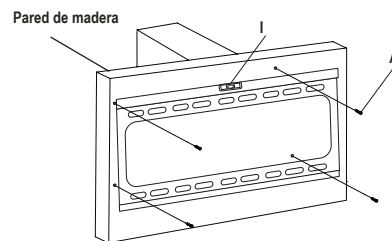
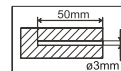

2. Coloque las barras de sujeción en la parte posterior de la pantalla. Elija 4 tornillos, 4 bujes y 4 rondanas para fijar las barras firmemente.

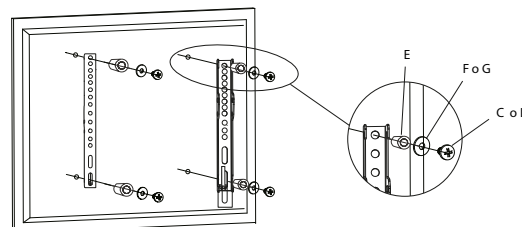

3. Instale la pantalla sobre el soporte. (Afloje los tornillos de seguridad para montar la pantalla sin dificultades. Apriete nuevamente los tornillos para asegurar las barras)

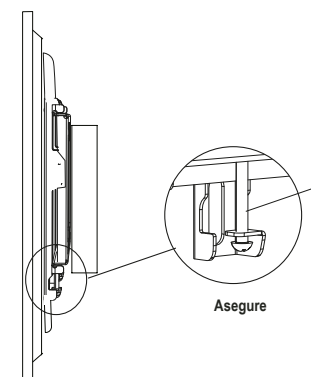
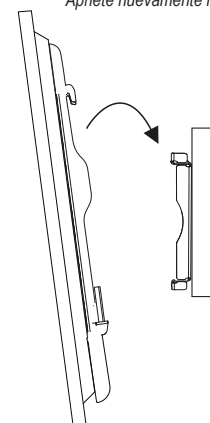

Asegure



Centro de Atención a Clientes
01 800 500 9000

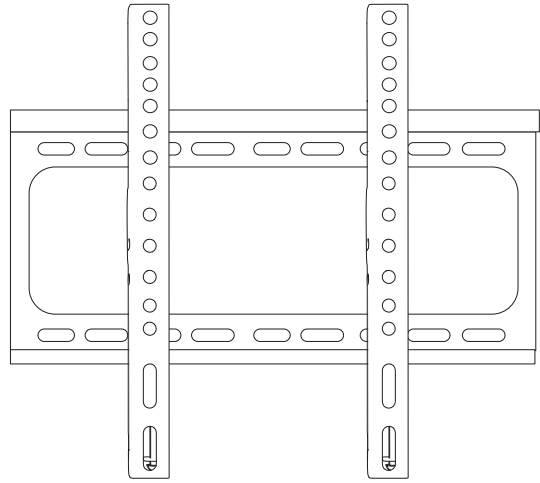

1018A

V0.0

25" to 50" TV Stand INSTRUCTION MANUAL

IMPORTANT

Before using the product, read this instruction carefully to avoid any malfunction. The information presented serves only as a reference for the product. Due to updates there may be differences. See our website www.steren.com for the latest version of this manual.



This device is not intended for use by persons (including children), whose physical, sensory or mental abilities are different or reduced, or lack experience or knowledge.

- Children should be supervised to ensure they do not use the device as a toy.



This product is designed for indoor use.



Choose a solid surface to be able to securely fix the support



- Do not exceed the maximum load capacity (25 kg).

CONTENT

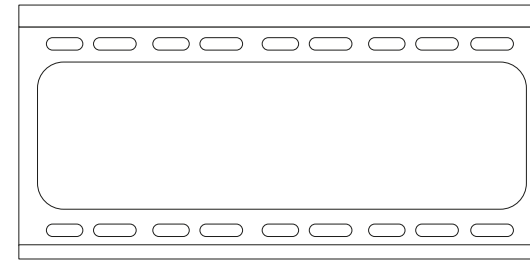

Support



Clamping bars

SCREWS AND RONDANES KIT

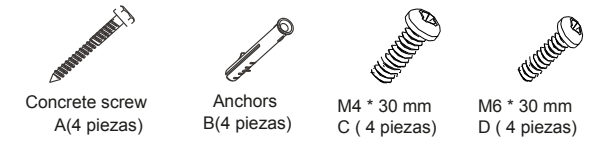

Drop Leveler
I (1 piece)

TOOLS NEEDED

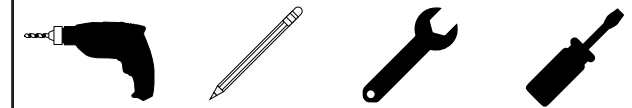

Not included

- Use the support and a leveler to make drilling marks on the surface where you want to install. Then, drill and install the screws as shown in the picture.

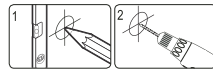
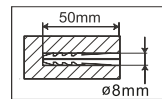

A) INSTALLATION in concrete

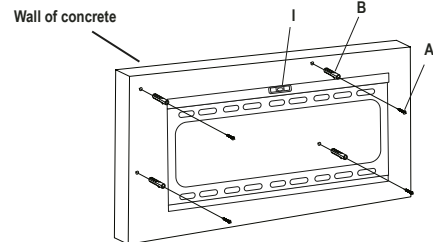

B) INSTALLATION in wood

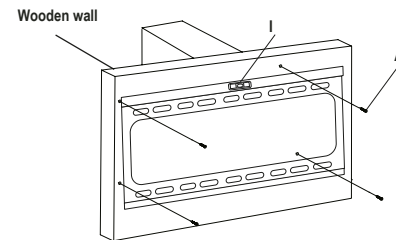
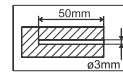

- Place the grab bars on the back of the screen. Choose 4 screws, 4 bushings and 4 washers to secure the bars firmly.

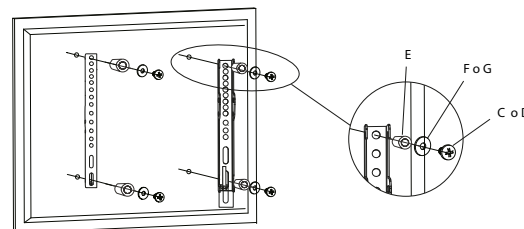

- Install the screen on the stand. (Loosen the security screws to mount the screen without difficulties.)

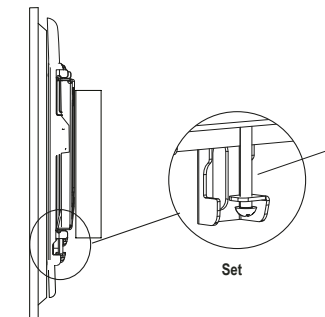
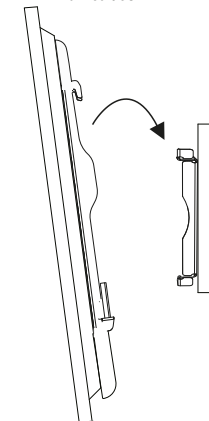

Set



Customer Care Center
01 800 500 9000